



TOP 5 CORRIDORS

REPORT
DECEMBER 2020
SACRAMENTO

Vision
ZERO

Acknowledgements

Elected Officials

Darrell Steinberg
Mayor

Jeff Harris (District 3)
Vice Mayor

Angelique Ashby
District 1

Allen Warren
District 2

Steve Hansen
District 4

Jay Schenirer
District 5

Eric Guerra
District 6

Rick Jennings, II
District 7

Larry Carr
District 8

City Staff

Ryan Moore
Director of Public Works

David Edrosolan
Interim Traffic Engineer

Jennifer Donlon Wyant
Transportation Planning Manager

Leslie Mancebo, Project Manager
Transportation Program Analyst

Project Mangement Team

Jesse Gothan
Supervising Engineer

Megan Johnson
Senior Engineer

William Shunk
Senior Engineer

Phil Vulliet
Senior Engineer

Ryan Billeci
Senior Engineer

James Sellards
Assistant Civil Engineer

Consultant Team

Fehr & Peers

David Carter

Bob Grandy

Adrian Engel

Emily Finkel

Becca Shafer

Cullen McCormick

Erika Kulpa

Mark Thomas

Aaron Silva

Josh Iniguez

AIM Consulting

Gladys Cornell

Nicole Porter



Table of Contents

7

Introduction

17

Countermeasure
Toolbox

31

Policy Toolbox

A-1

El Camino
Avenue

B-1

Marysville
Boulevard



C-1

**Broadway/
Stockton
Boulevard**

D-1

**Stockton
Boulevard (South)**

E-1

**Florin
Road**

A-A

**Appendix A-
Related Documents**

A-B

**Appendix B-
Technical
Calculations**

A-C

**Appendix C-
Concept Plans and
Cost Estimates**





TOP 5 CORRIDORS

Vision
ZERO

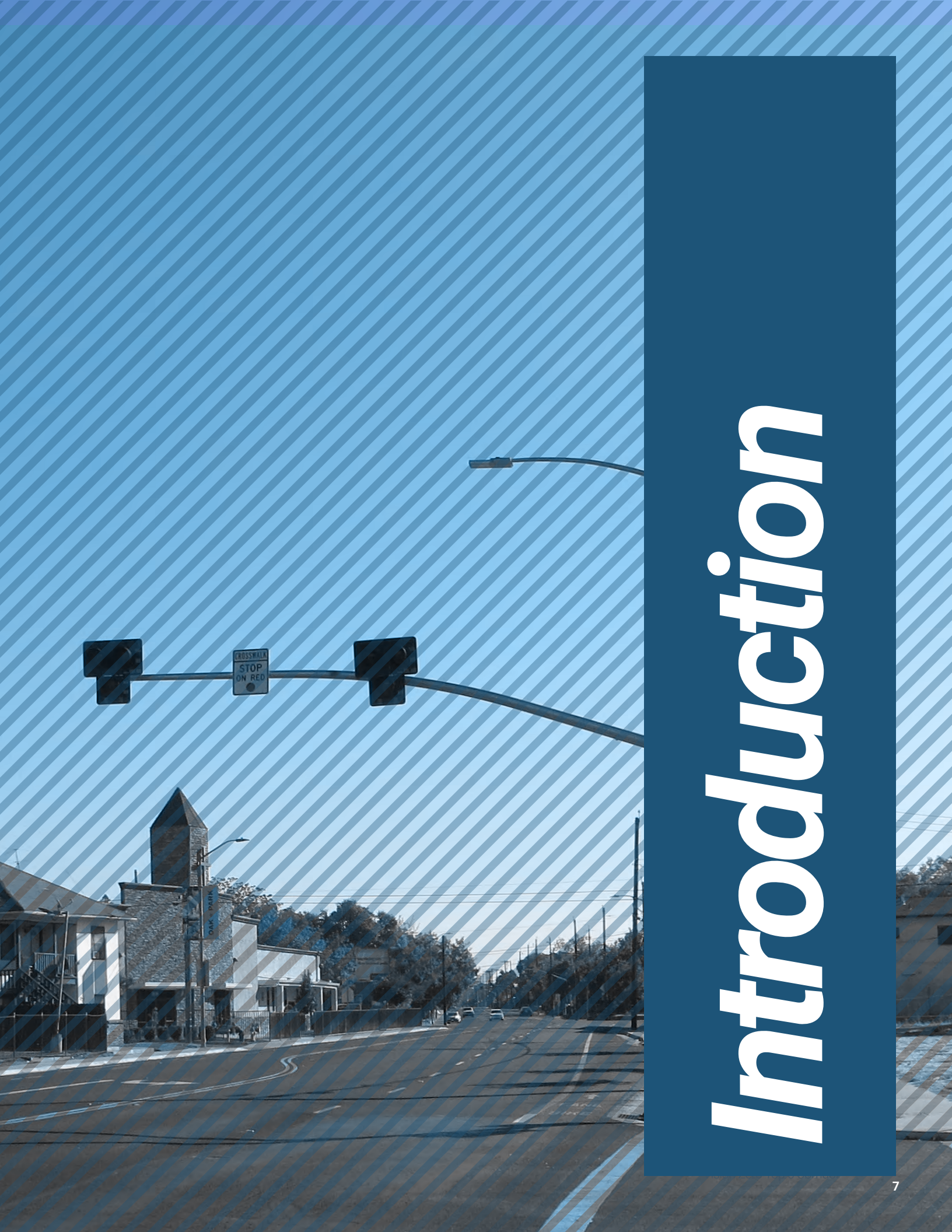

Introduction

Introduction

This report presents recommended roadway safety projects for the five one-mile roadway segments with the highest numbers of fatal and serious crashes involving pedestrians, bikes, and motor vehicles in the City of Sacramento. These corridors are:

- **Broadway/Stockton Boulevard:** Martin Luther King Jr. Boulevard to Stockton Boulevard and Broadway to 13th Avenue
- **El Camino Avenue:** Del Paso Boulevard to Steelhead Creek trail crossing
- **Florin Road:** 24th Street to Munson Way
- **Marysville Boulevard:** North Avenue to Arcade Boulevard
- **Stockton Boulevard (South):** McMahon Drive to Patterson Way

Each corridor has its own chapter documenting key features along the corridor such as neighborhood demographics, destinations, and travel statistics, as well as its crash analysis and proposed countermeasures, including their cost and effect on travel.



Top 5 Corridors







What is Vision Zero?

Vision Zero is a traffic safety philosophy that rejects the notion that traffic crashes are simply “accidents,” but instead preventable incidents that can and must be systematically addressed. Vision Zero starts with the belief that everyone has the right to move safely in their communities, and that system designers and policy makers share the responsibility to ensure safe systems for travel. Through Vision Zero, the City of Sacramento and its partners are committed to working together to create safer streets. In January 2017, the City Council issued a call to action by adopting a resolution with the following goal: **The City of Sacramento will work corroboratively in a data-driven effort to eliminate traffic fatalities and serious injuries by 2027.** Thus, the Vision Zero Action Plan was created, and the document was approved by City Council August 2018.

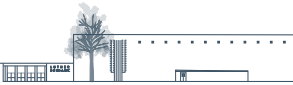

What is the Vision Zero Top 5 Corridor Study?

This study represents a critical next step in the implementation of Sacramento’s Vision Zero program, focusing efforts on implementing near-term roadway improvements on the five corridors within the City that have the highest rates of crashes that result in fatalities and severe injuries. These five corridors were identified through developing of the High Injury Network (HIN), which was developed as a part of the Vision Zero Action Plan. The HIN is based on seven years of crash data (2009 through 2015) for all travel modes, analyzed from the statewide Transportation Injury Mapping System (TIMS).

<p>1. El Camino Ave</p>  <ul style="list-style-type: none"> ● Del Paso Boulevard to ● Steelhead Creek trail crossing 	<p>4. Stockton Boulevard (South)</p>  <ul style="list-style-type: none"> ● McMahon Drive to ● Patterson Way
<p>2. Marysville Boulevard</p>  <ul style="list-style-type: none"> ● North Avenue to ● Arcade Boulevard 	<p>5. Florin Rd</p>  <ul style="list-style-type: none"> ● 24th Street to ● Munson Way
<p>3. Broadway/Stockton Boulevard</p>  <ul style="list-style-type: none"> ● Martin Luther King Jr. Boulevard to ● Stockton Boulevard <ul style="list-style-type: none"> ● Broadway to ● 13th Avenue 	

The “existing conditions” of these corridors (e.g., current travel trends and collision analysis for the years 2009 through 2017) were presented in the Vision Zero Top 5: Existing Conditions Report (see Appendix A).. The Top 5 Corridors Report contains the proposed countermeasures for each of the five corridors, including measured statistics on how implementation of the countermeasures will affect travel and how much they will cost.

Relationship to Vision Zero Action Plan

To help reach its goal of eliminating traffic fatalities and serious injuries by 2027, the City of Sacramento developed a Vision Zero Action Plan, which was adopted by the City Council in August 2018. The Plan used historic crash data to pinpoint the factors contributing to traffic deaths and serious injuries, and it identified proven safety countermeasures to address those factors through education, engineering, enforcement, and evaluation. This Top 5 Corridor Study represents a critical next step in the implementation of City of Sacramento’s Vision Zero Program, focusing efforts on implementing near-term improvements on the five corridors within the City that have the highest rates of crashes that result in fatalities and severe injuries.

Identification of Segments

A High Injury Network (HIN) was developed for the City of Sacramento as part of the Vision Zero Action Plan. The HIN identifies corridors with the highest number of fatal and severe crashes for all travel modes (i.e., vehicle, bike, and pedestrian) to better understand existing transportation safety challenges in the City. Seven years of crash data, from 2009 through 2015, was analyzed from the statewide Transportation Injury Mapping Systems (TIMS). TIMS data includes only those crashes that resulted in an injury, ranging from “complaint of pain” to “fatal.” Crashes resulting in only property damage, either to a vehicle or other property, are not included in the TIMS data set and were not analyzed as part of the Vision Zero Action Plan and HIN development.

A weighted crash score was created for each roadway segment; crashes involving a fatality or severe injury were given a score of 3, and all other injury crashes were given a score of 1. Weighted crash scores were then analyzed as a rate based on segment length. Segments with a weighted crash score greater than 1 per 300 ft of roadway were included on the HIN.

Once the HIN was developed, the network was divided into corridors approximately one mile in length, to allow for direct comparison and selection of the highest priority corridors. Fehr & Peers identified the ten corridors on the HIN with the highest number of fatal and severe injury crashes per mile.

Each of these corridors have between 10.4 and 7.1 fatal or severe injury crashes per mile. The next five ranked corridors (#6-10) have fatal and severe injury collision rates between 6.2 and 2.1.



Safety Context Overview

Total Crashes by Year

Figure 1 displays the number of annual injury crashes along each corridor between 2009 and 2017. This figure shows the following:

- The fewest crashes in a year occurred on the Broadway/Stockton Boulevard corridor in 2015, and the highest number of crashes in a year occurred on Florin Road in 2016.
- During the study period, Broadway/Stockton Boulevard is the corridor with the lowest number of total crashes, and Florin Road is the corridor with the highest number of crashes.
- While there were fewer overall crashes between 2012 and 2014, crashes are trending back up to peak numbers seen in 2009 and 2010.

Figure 1: Total Crashes by Year

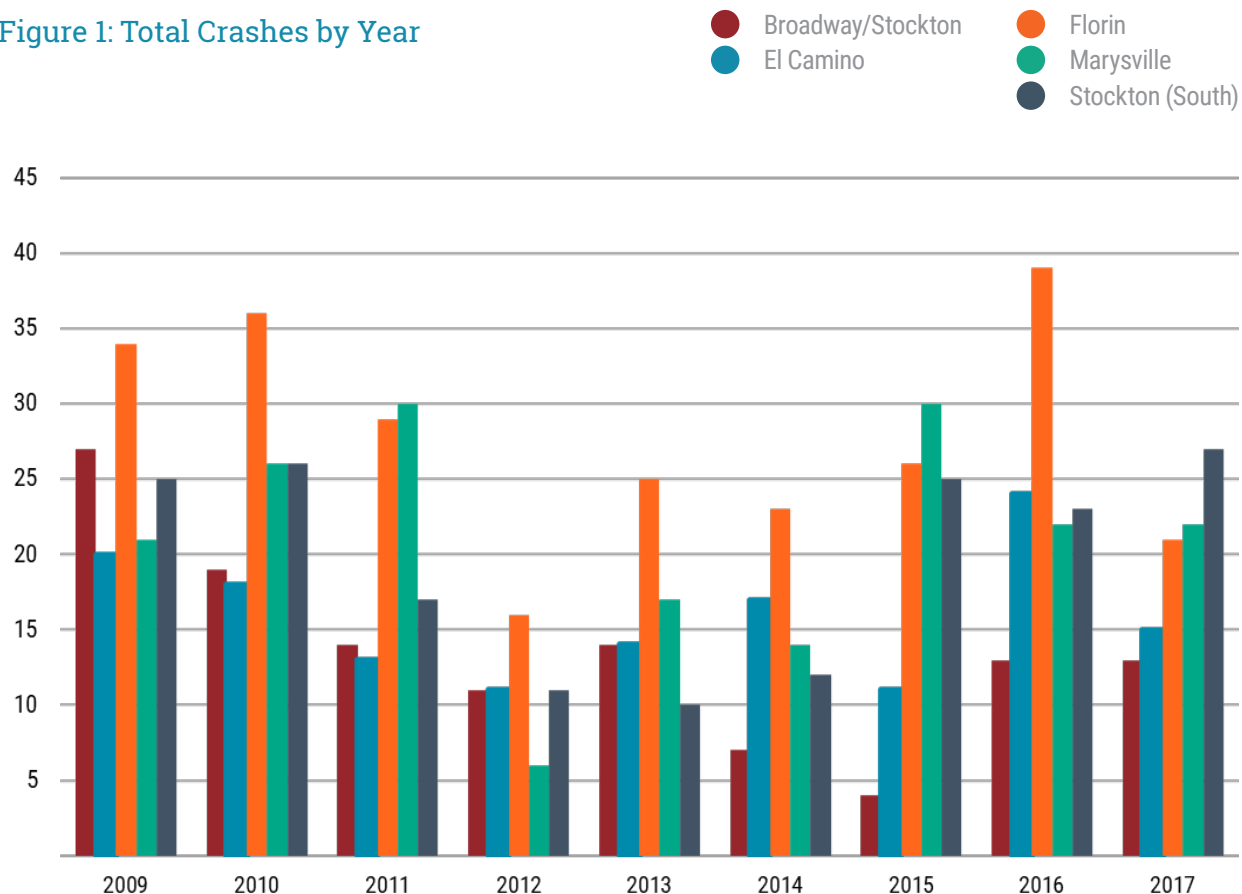

Total Crashes by Mode

Figure 2 displays the number of injury crashes by mode along each corridor between 2009 and 2017 as total and percentages. This figure shows the following:

- Despite having the lowest number of crashes overall, the Broadway/Stockton Boulevard corridor has the largest share of crashes involving a bicyclist (24 crashes, or 20 percent).
- The Marysville Boulevard corridor has the largest share of crashes involving a pedestrian (25 crashes, or 13 percent).
- In absolute numbers, the Florin Road corridor accounts for the highest number of crashes involving pedestrians (28 crashes), bicyclists (29 crashes), and vehicle-vehicle crashes (192 crashes).

Figure 2: Total Crashes by Mode

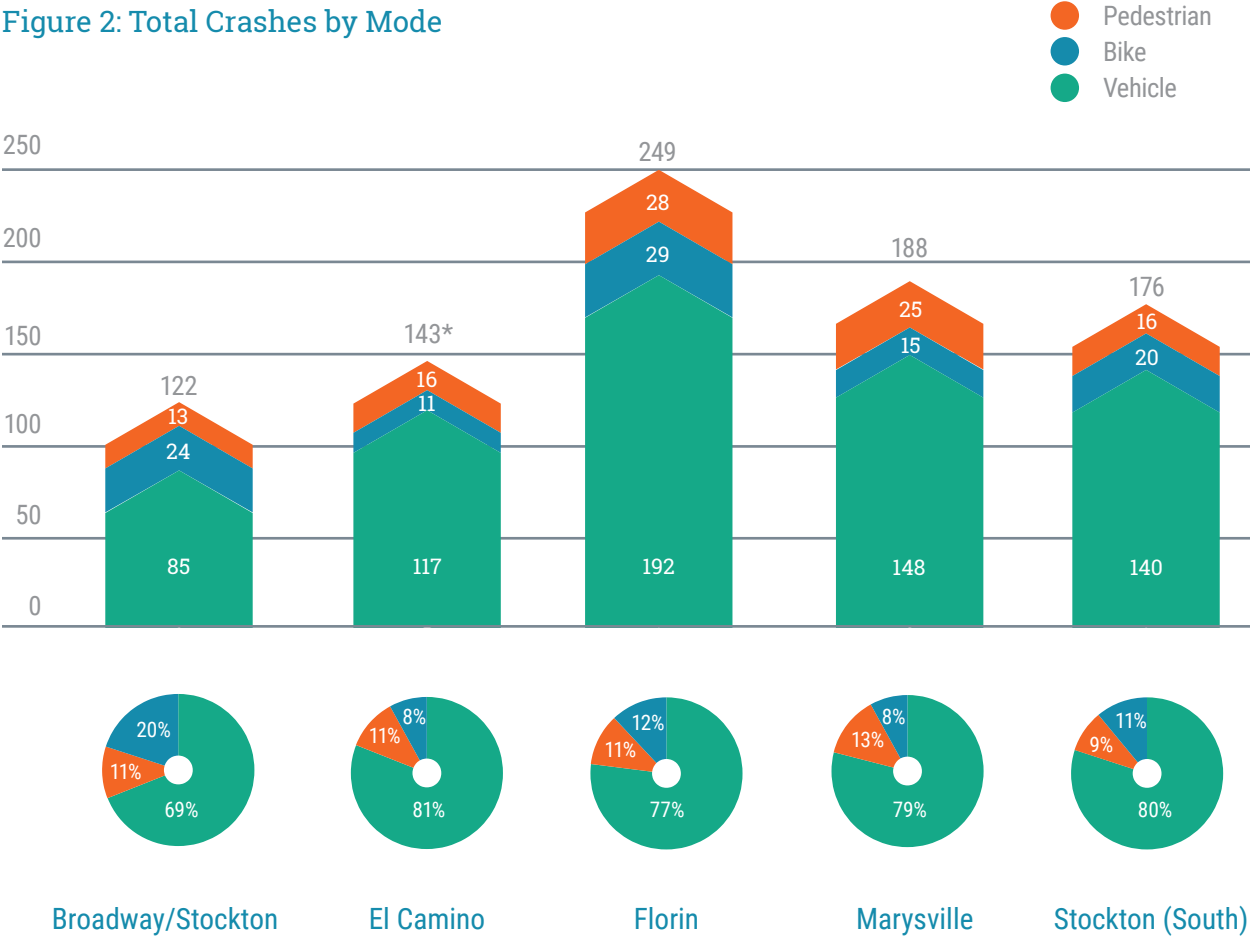

*One crash on El Camino involved both a pedestrian and a bicyclist.

Total Crashes by Severity

Figure 3 displays the number of crashes that resulted in a fatality or serious injury (also called a KSI) along each corridor between 2009 and 2017. This figure shows the following:

- Despite having the lowest number of total crashes overall, the Broadway/Stockton Boulevard corridor has the largest share of

crashes that result in a fatality or serious injury (15 crashes, or 12 percent of all injury crashes).

- The Marysville Boulevard corridor has the highest absolute number of crashes resulting in a fatality or serious injury (19 crashes).

Throughout this report, the acronym KSI is used to denote crashes where someone was killed or seriously injured.

Figure 3: Total Crashes by Severity

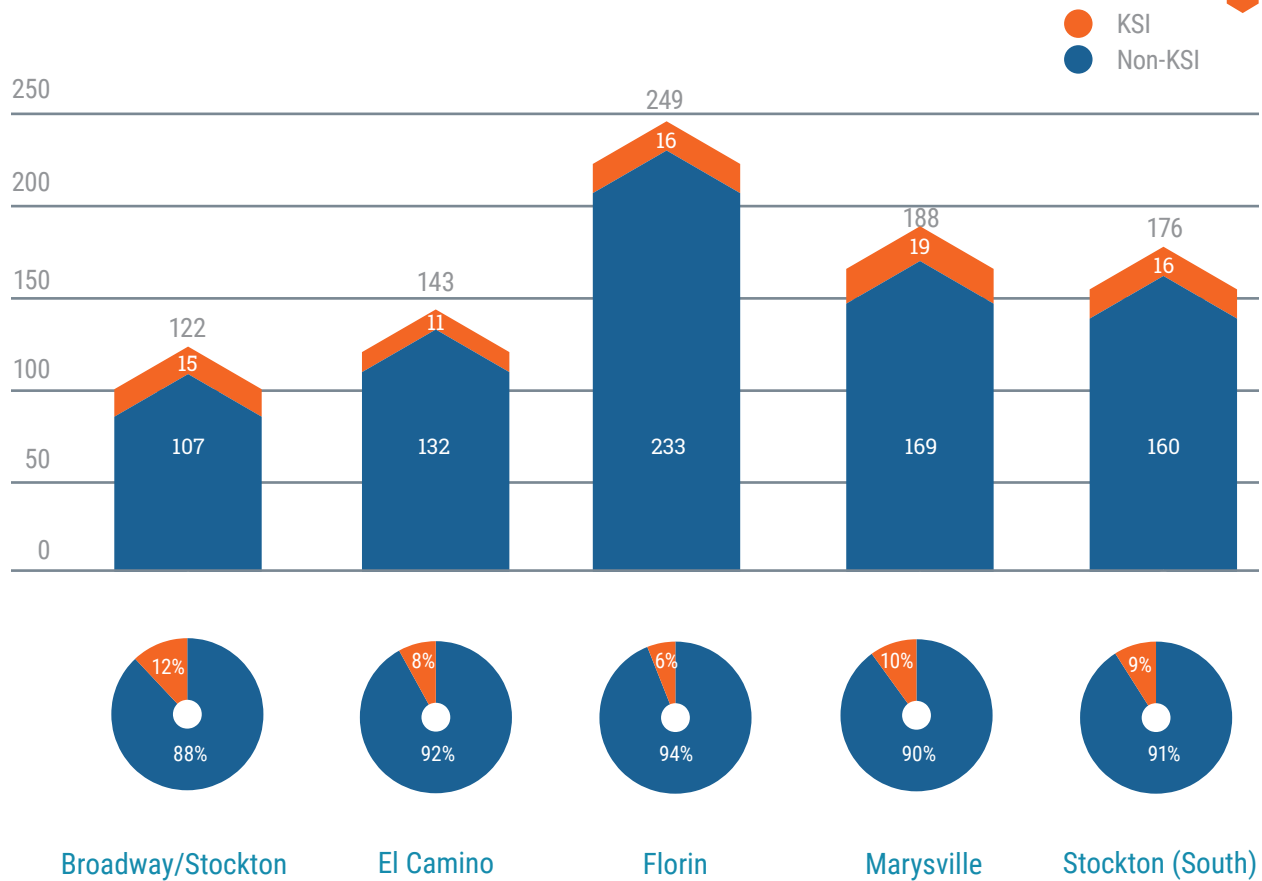

KSI Crashes by Mode

Figure 4 displays the number of crashes by mode that resulted in a fatality or serious injury between 2009 and 2017. This figure shows the following:

- The Marysville Boulevard corridor has the highest number and largest share of KSI crashes that involved a bicyclist (four crashes, or 25 percent of KSI crashes).
- The El Camino Avenue corridor does not have any bike crashes that resulted in a fatality or serious injury.
- The Stockton Boulevard (South) corridor has the highest number and largest share of KSI crashes that involved a bicyclist (four crashes, or 25 percent of KSI crashes).
- The El Camino Avenue corridor does not have any bike crashes that resulted in a fatality or serious injury.

Figure 4: KSI Crashes by Mode

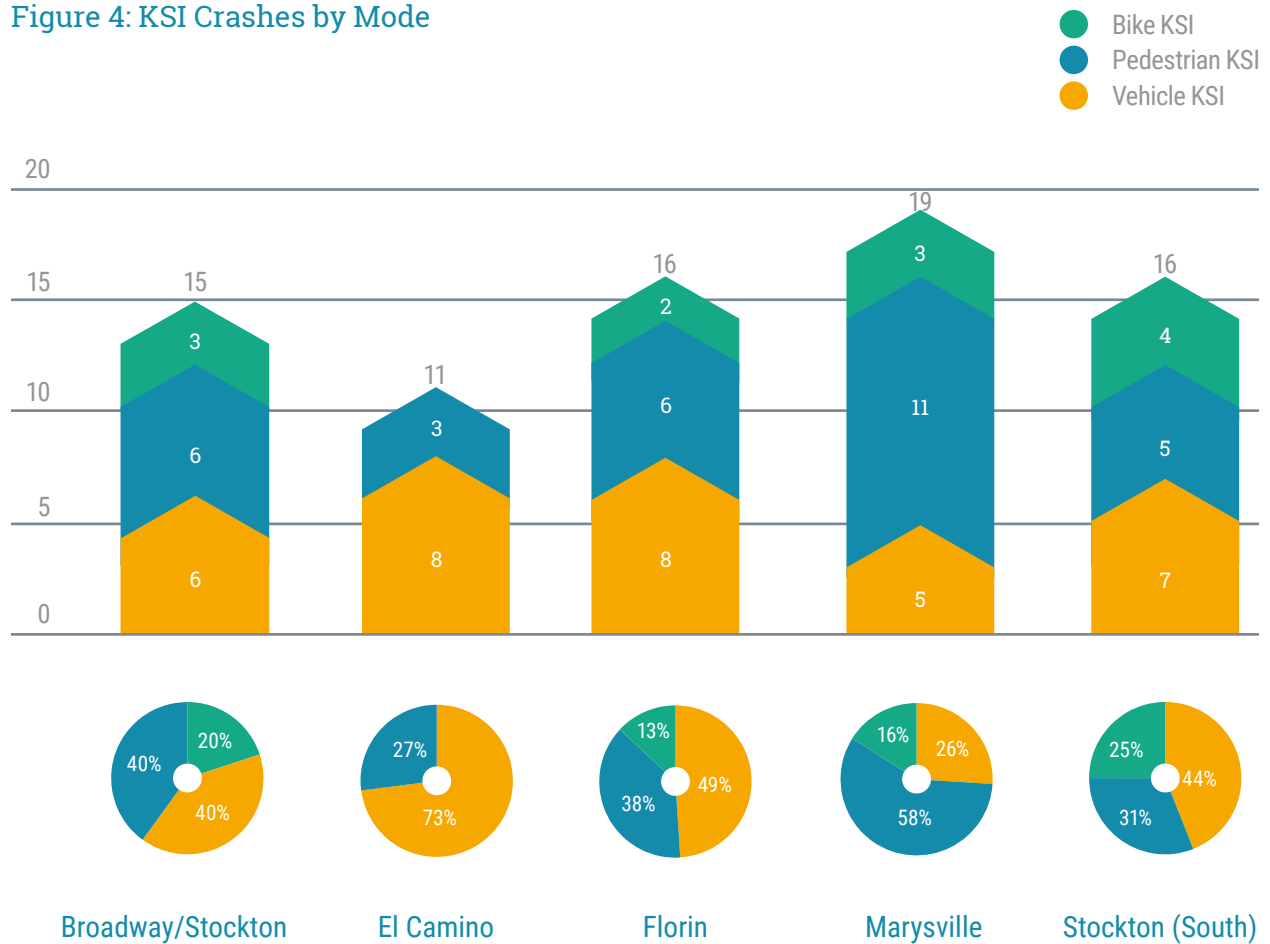



TOP 5 CORRIDORS

Vision
ZERO

The background of the page is a photograph of an outdoor paved area. In the foreground, there is a dark asphalt road with a white curved line. To the left, there is a concrete curb and a utility box. In the background, there is a black metal fence and some trees. The entire image is overlaid with a diagonal orange and white striped pattern.

Countermeasure Toolbox

Countermeasure Toolbox

Introduction

This toolbox presents the roadway safety countermeasures applicable on each of the Top 5 Corridors. These countermeasures have been selected specifically for their efficacy in creating safer environments for people traveling on Sacramento's streets, regardless of mode. Many of the countermeasures are included in the Caltrans Local Roadway Safety Manual (LRSM) and can be advantageous for use in Caltrans Highway Safety Improvement Program (HSIP) grant funding applications. In the toolbox, these countermeasures are noted by an LRSM ID numbers, and include a Caltrans-approved Crash Reduction Factor (CRF) as defined in the LRSM. The higher the CRF, the greater the expected reduction in crashes. There are many effective safety countermeasures beyond those listed in the LRSM, and several are included in this toolbox. Some of these countermeasures include an associated CRF, which is based on academic research and before-and-after studies, as compiled and reported by the Federal Highway Administration (FHWA).

How to use the Toolbox

A-Z

The countermeasure tools are listed in alphabetical order.

Caltrans Local Road Safety Manual ID

Crash Reduction Factor

Icon

Name

Safety Issue Category

Description

Close Bike Lane Gap

🔗 Bike Safety

R36 35%

Green pavement within a bike lane to increase visibility of bicyclists and to reinforce bike priority. The green pavement is used as a spot treatment in conflict areas such as driveways.

List of Countermeasures



Advanced Dilemma-Zone Detection



Advanced Stop Bar



Bike Conflict Zone Markings



Bulbout



Bus Boarding Islands



Class II Bike Lane



Close Bike Lane Gap

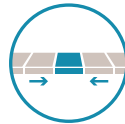

Close Sidewalk Gap



Co-Locate Bus Stops & Pedestrian Crossings



Consolidate Driveways



Countdown Pedestrian Signal Heads



Dual Curb Ramps



Extend Bike Lane to Intersection



Extend Pedestrian Crossing Time



Extend Signal Clearance Time



High Visibility Crosswalk



Intersection Tightening



Landscape Buffer



Leading Pedestrian Interval

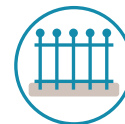

Median Barrier Fencing



Narrow Lanes



New Pedestrian Signal



New Traffic Signal



Parking Prohibition



Partial Closure



Pedestrian Recall Signal Timing



Pedestrian Refuge Island



Pedestrian Scale Lighting



Pedestrian Scramble



Prohibit Left Turn

List of Countermeasures (cont.)



Prohibit Turns During Pedestrian Phase



Protected Left Turns



Provide Green Time For Bikes

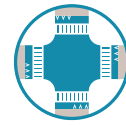

Raised Intersection



Raised Median



Realign Intersection to 90 Degrees



Red Light Camera

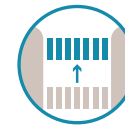

Relocate Crosswalk



Remove Dual Left Turn Lanes



Remove Right Turn Slip Lane



Remove Sight Obstruction



Road Closure

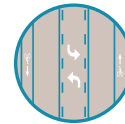

Road Diet



Roundabout

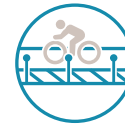

Separated/Buffered Bikeway



Shorten Signal Cycle Length



Slow Green Wave

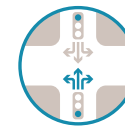

Split Signal Phase



Stop Sign



Straighten Crosswalk



Widen Sidewalk

Countermeasures A-C



S4 40%

Advanced Dilemma-Zone Detection

📍 Signals/Signage

Advanced dilemma-zone detection enhances safety at signalized intersections by modifying traffic control signal timing on the fly to reduce the number of drivers that may have difficulty deciding whether to stop or proceed during a yellow phase. This may reduce rear-end crashes associated with unsafe stopping and angle crashes due to red light running.



S20 15%

Advanced Stop Bar

📍 Crossing, Pedestrian Safety

A stop bar placed ahead of the crosswalk at stop signs and signals reduces instances of vehicles encroaching on the crosswalk.



Bike Conflict Zone Markings

📍 Bike Safety

Green pavement within a bike lane to increase visibility of bicyclists and to reinforce bike priority. The green pavement is used as a spot treatment in conflict areas such as driveways.



Bulbout

📍 Crossings, Pedestrian Safety, Speed, Visibility

Raised devices, usually constructed from concrete, landscaping, or paint and plastic materials, that narrow the roadway to reduce speeds of turning vehicles, improve sight lines, and shorten pedestrian crossing distances.



Bus Boarding Islands

📍 Bike Safety, Pedestrian Safety

Dedicated waiting and boarding areas for passengers that are separated from the sidewalk by a bike channel, eliminating conflicts between transit vehicles and bikes at stops.



R32 35%

Class II Bike Lane

📍 Bike Safety

Five to seven foot wide designated lanes for bicyclists adjacent to vehicle travel lanes, delineated with pavement markings.

Countermeasures C - D



R32 35%

Close Bike Lane Gap

🔗 Bike Safety

Closing gaps between bike lanes increases the amount of dedicated facilities bicyclists can use, reducing mixing of bicyclists and drivers and increasing network connectivity and visibility of bicyclists in the roadway.

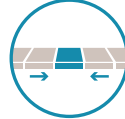

R34 80%

Close Sidewalk Gap

🔗 Pedestrian Safety

Providing continuous sidewalks for pedestrians provides a separated facility for people to walk along the roadway, and can help minimize crashes with pedestrians walking in the road.



Co-Locate Bus Stops and Pedestrian Crossings

🔗 Crossing, Pedestrian Safety

Place bus stops and pedestrian crossings in close proximity to allow transit riders to cross the street safely.



Consolidate Driveways

🔗 Bike Safety, Pedestrian Safety, Visibility

Reducing the number of driveway entrances/exits through consolidation limits the exposure of bicyclists, pedestrians, and drivers to vehicles entering or exiting driveways, reducing conflicts.



S17 25%

Countdown Pedestrian Signal Heads

🔗 Crossings, Pedestrian Safety, Signals/Signage

Displays “countdown” of seconds remaining on the pedestrian signal. Countdown indications improve safety for all road users, and are required for all newly installed traffic signals where pedestrian signals are installed.



🔗 Pedestrian Safety

Dual Curb Ramps

Dual curb ramps, opposed to single angled curb ramps, improve ADA accessibility at all intersection approaches so that pedestrians with mobility challenges, or those pushing carts or strollers, can safely enter and exit all crosswalks. These are curb ramps that provide a slope for two directions of the curb, instead of single angled curb ramps.

Countermeasures E - L

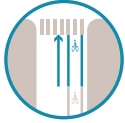

Extend Bike Lane to Intersection

🔗 Bike Safety

In locations where a bike lane is dropped due to the addition of a right turn pocket, the intersection approach may be restriped to allow for bicyclists to move to the left side of right-turning vehicles ahead of reaching the intersection.



S3 15%

Extend Pedestrian Crossing Time

🔗 Crossings, Pedestrian Safety

Increases time for pedestrian walk phases, and can better accommodate vulnerable populations such as children and the elderly.



S3 15%

Extend Signal Clearance Time

🔗 Signals/Signage

Extending yellow and all red time allows drivers and bicyclists to safely cross through a signalized intersection before conflicting traffic movements are permitted to enter the intersection.



S18/NS20 25%

High Visibility Crosswalk

🔗 Crossings, Pedestrian Safety, Visibility

A crosswalk designed to be more visible to approaching drivers, striped with ladder markings using high-visibility material such as thermoplastic tape instead of paint.



Intersection Tightening

🔗 Crossings, Pedestrian Safety, Speed, Visibility

Uses temporary materials like paint, plastic bollards, and reflective markers to visually and physically narrow the street at intersections, which can create a shorter crossing for pedestrians and slows vehicles approaching the intersection and turning.



Landscape Buffer

🔗 Pedestrian Safety

Separating drivers from bicyclists and pedestrians using landscaping provides more space between the modes and can produce a traffic calming effect by encouraging drivers to drive at slower speeds, lowering the risk of crashing.

Countermeasures L - P



S21 60%

Leading Pedestrian Interval

📍 Crossings, Pedestrian Safety, Visibility

Traffic signals timed to allow pedestrians a short head start in crossing an intersection to minimize conflicts with turning vehicles and improve pedestrian visibility.

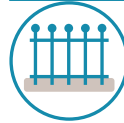

R3 25%

Median Barrier Fencing

📍 Crossings, Pedestrian Safety

Pedestrian median barriers restrict pedestrians from crossing the median at locations where nearby crossings are available and midblock crossings may have poor sight lines or insufficient safety enhancements for the conditions.



Narrow Lanes

📍 Speed

A reduction in lane width, to 11 feet, produces a traffic calming effect by encouraging drivers to travel at slower speeds, lowering the risk of crashing with bicyclists, pedestrians, and other drivers.



New Pedestrian Signal

📍 Crossings, Pedestrian Safety

Pedestrian signals (also called “half signals”) can be implemented at mid-block crossing locations to enhance crosswalk safety and increase driver yielding. The signals consist of standard (red-yellow-green) signal heads controlling the roadway approaches, and function similar to a standard traffic signal when actuated by a pedestrian or bike push-button or detection.



NS3 30%

New Traffic Signal

📍 Signals/Signage

New traffic signals help organize travel of all modes at an intersection, limiting interactions between vehicles, pedestrians, and bicyclists with conflicting movements. New signals can have a traffic calming effect on long, high-speed straightaways.

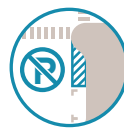

30%

Parking Prohibition Near Intersections

📍 Bike Safety, Crossings, Pedestrian Safety, Signals/Signage

By restricting parking at curbs in front of intersection crosswalks, sight lines are cleared between pedestrian crossings and oncoming drivers, reducing the risk of crashing (also called “daylighting”).

Countermeasures P - P



Partial Closure

📌 Bike Safety, Crossings, Pedestrian Safety

Partial closures, using a physical barrier across one direction of traffic at an intersection allow full bicyclist and pedestrian passage while restricting vehicle access in one direction. This strategy can be used to minimize conflict points at complicated intersections.



Pedestrian Recall Signal Timing

📌 Pedestrian Safety, Signals/Signage

Signals can be put in “recall” for key time periods of the day such as peak business hours or school drop-off/pick-up times. The “WALK” signal would be displayed every signal cycle without prompting by a pedestrian push button.



S12/NS14

25%

Pedestrian Refuge Island

📌 Crossings, Pedestrian Safety, Speed, Visibility

Pedestrian refuge islands provide a protected area for pedestrians at the center of the roadway. They reduce the exposure time for pedestrians crossing the intersection and simplify crossings by allowing pedestrians to focus on one direction of traffic at a time.



S1/NS1/R1

35-40%

Pedestrian Scale Lighting

📌 Crossings, Pedestrian Safety, Visibility

Appropriate quality and placement of lighting can enhance an environment as well as increase comfort and safety. Pedestrian-scale lighting is lower in height than standard streetlighting and is spaced closer together.



S19

40%

Pedestrian Scramble

📌 Crossings, Pedestrian Safety, Signals/Signage

Restricts vehicular movements to provide an exclusive signal phase allowing pedestrians to cross in all directions, including diagonally.



S15/NS16

50%

Prohibit Left Turn

📌 Bike Safety, Crossings, Pedestrian Safety, Signals/Signage

Prohibitions of left turns at locations where a turning vehicle may conflict with pedestrians in the crosswalk or where opposing traffic volume is high. Reduces pedestrian interaction with vehicles when crossing.

Countermeasures P - R



Prohibit Turns During Pedestrian Phase

📍 Crossings, Pedestrian Safety, Signals/Signage

Restricts left or right turns during the pedestrian crossing phase at locations where a turning vehicle may conflict with pedestrians in the crosswalk. This restriction may be displayed with a blank-out sign.



S6/S7

30-55%

Protected Left Turns

📍 Signals/Signage

Protected left turns provide an exclusive phase for left-turning vehicles to enter an intersection separate from any conflicting vehicle or pedestrian movements.



S3

t15%

Provide Green Time For Bikes

📍 Bike Safety, Signals/Signage

Provide or prolong the green phase when bicyclists are present to provide additional time for bicyclist to clear the intersection. Can occur automatically in the signal phasing or when prompted with bike detection. Topography should be considered in clearance time.

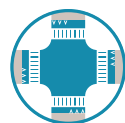

Raised Intersection

📍 Crossings, Pedestrian Safety, Speed

Raised intersections are flush with the sidewalk and ensure that drivers traverse the crosswalk slowly. Similar to speed humps and other vertical speed control elements, they reinforce slow speeds and encourage motorists to yield to pedestrians at the crosswalk.



S12/NS14/R8

25%

Raised Median

📍 Crossings, Pedestrian Safety, Speed

Curbed sections in the center of the roadway that are physically separated from vehicular traffic. Raised medians can also help control access to and from side streets and driveways, reducing conflict points.



Realign Intersection to 90 Degrees

📍 Crossings, Pedestrian Safety, Speed, Visibility

By eliminating acute or obtuse angles between intersection roadways, intersection sight distance may be improved, allowing drivers to see pedestrians more easily. Right-angle intersections can also help to slow down turning vehicles.

Countermeasures R - R



Red Light Camera

📌 Signals/Signage

Red light cameras can be used for automated enforcement to issue citations to drivers running red lights at signalized intersections, and may discourage this behavior.



Relocate Crosswalk

📌 Crossings, Pedestrian Safety, Visibility

Relocating existing crosswalks can help improve pedestrian visibility, shorten crossing distances, and minimize conflicts with vehicles. In some cases, crosswalks currently located between two legs of an offset intersection may be moved to the far side of the intersection to minimize the number of conflicting vehicle turning movements.



Remove Dual Left Turn Lanes

📌 Signals/Signage

Restriping an approach so there is a single left-turn lane instead of dual lefts can help simplify an intersection and create room for a road diet or other geometric improvements.

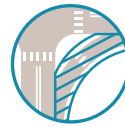

Remove Right Turn Slip Lane

📌 Bike Safety, Pedestrian Safety, Speed

Closing a free-flow right-turn slip lane can help slow right turning drivers, eliminates an uncontrolled crossing for pedestrians, and shortens pedestrian crossing distances. The space reclaimed in closing the slip lane can be reused as pedestrian space to widen sidewalks, enhance curb ramps, or provide more space for street furniture.



NS11 20%

Remove Sight Obstruction

📌 Visibility

Remove objects that may prevent drivers and pedestrians from having a clear sightline. May include trimming or removing landscaping, or removing or relocating large signs.



Road Closure

📌 Bike Safety, Crossings, Pedestrian Safety

Road closures, using a physical barrier, allow full bicyclist and pedestrian passage while restricting vehicle access. This strategy can be used to minimize conflict points at complicated intersections or to minimize conflicting movements due to turning vehicles.

Countermeasures R - S

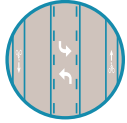

R14 30%

Road Diet

Speed, Pedestrian Safety, Bike Safety, Crossings

Road diets generally reassign space in the roadway from vehicle travel lanes to create room for bike facilities, wider sidewalks, or center turn lanes. Road diets optimize street space to benefit all users by improving the safety and comfort of pedestrians and bicyclists, and reducing vehicle speeds and the potential for rear end crashes.



R33 45%

Separated/Buffered Bikeway

Bike Safety

Designated bike lanes, separated from vehicle traffic by a physical barrier, usually bollards, landscaping, or parked cars. These facilities can increase safety by decreasing opportunities for crashing with overtaking vehicles, and reducing the risk of dooring.



Slow Green Wave

Signals/Signage, Speed

A series of traffic signals coordinated to allow for slower vehicle travel speeds through several intersections along a corridor. Coordinating signals for slower travel speeds gives bicyclists and pedestrians more time to cross safely and encourages drivers to travel at slower speeds.

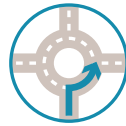

S16/NS4/NS5 35-67%

Roundabout

Bike Safety, Crossings, Pedestrian Safety, Signals/Signage

Roundabouts are large circular islands, placed in the middle of an intersection, which direct flow in a continuous circular direction around the intersection. Roundabouts can reduce the number of conflict points, compared to an uncontrolled intersection, and decrease vehicle speeds due to intersection geometry. Converting signalized intersections to roundabouts can be especially effective at complex intersections or intersections with high left-turn volumes.



S3 15%

Shorten Signal Cycle Length

Signals/Signage

Reducing the cycle length at intersections may reduce the delay experienced by vehicles, bicyclists, and pedestrians. When delay is significant, road users are more inclined to ignore signal indications.

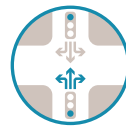

Split Signal Phase

Signals/Signage

Opposing legs of an intersection each receive their own phase.

Countermeasures S - W



Stop Sign

📌 Signals/Signage

When warranted, stop signs provide a cue to drivers to stop and wait for vehicles, bicyclists, and pedestrians to cross before proceeding.



Straighten Crosswalk

📌 Crossings, Pedestrian Safety, Visibility

Straightening crosswalks improves sight lines, making pedestrians more visible to oncoming drivers, and may shorten the crossing distance, reducing the length of time required for pedestrians to cross an intersection.

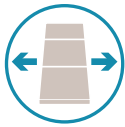

Widen Sidewalk

📌 Pedestrian Safety

Wide sidewalks can provide space for both pedestrians and bicyclists to use a shared facility. Wide sidewalks can be important for locations with high volumes of pedestrians.



TOP 5 CORRIDORS

Vision
ZERO



Policy Toolbox

Policy Toolbox

Introduction

As part of the Vision Zero Action Plan, adopted by City Council in August 2018, the City committed to a series of actions that focus on achieving the Vision Zero goal of eliminating traffic fatalities and serious injuries. The development of the Top 5 Corridor Study has provided additional insight into specific tools to consider when updating policies to achieve the Vision Zero goal. Clearly defining policies will allow them to be regularly incorporated into future plans and projects.

Signal Policies

Consistent with Vision Zero Action 5.4 it is recommended that the City update its signal timing policy to improve safety for all modes.

Based upon experience on the Top 5 corridors, some signal timing policies to consider as part of this update include the following:



Maximum Cycle Length

Recommend that the City consider establishing a practice to determine a maximum cycle length for a corridor or intersection, especially along the High Injury Network.

What is Maximum Cycle Length?

A cycle length is the amount of time required to display all phases (red, yellow, green) for each direction of an intersection before returning to the starting point. Cycle lengths are based on traffic volumes and work best within a certain range depending on the conditions of the corridor and intersection. Shorter signal cycles can reduce overall pedestrian wait times and result in improved pedestrian compliance.



Minimum Green Time

Recommend that the City review industry best practices, State and Federal guidance to update the practice for calculating minimum green time with the next update to City signal timing policy.

What is Minimum Green Time?

The minimum green time is the least amount of time that a green signal will be displayed for a specific movement. The time for pedestrians and/or bicyclists crossing with a phase must also be considered and included in the minimum phase length.



Flash Don't Walk Time

Recommend that the City review its practice for calculating pedestrian clearance time with the next update to City signal timing policy.

What is Walk/Flash Don't Walk Time?

The "Flashing Don't Walk" interval follows the "Walk" interval and is often accompanied by a countdown signal. It is used to alert pedestrians that they need to finish crossing and if there is a countdown, it lets pedestrians know how long they have to do so.



Yellow and All Red Clearance Time

Recommend that the City review its practice for calculating intersection clearance times with the next update to City signal timing policy.

What are Clearance Times?

Clearance times include the yellow light and the "all-red" signal time. The yellow signal provides time for approaching vehicles to slow and stop and the "all-red" is the time when a signal is changing from one phase (red, yellow, green) to the next giving time for all vehicles to clear the intersection.



Slow Green Wave

Recommend that the City investigate controlling the travel speed of vehicles by optimizing the cycle length, splits, and offsets to the posted speed or lower where appropriate.

What is a Slow Green Wave?

The concept of a "slow green wave" is a series of traffic signals coordinated to allow for uninterrupted traffic flow of vehicles traveling at the speed limit or lower and require those traveling at faster speeds to stop more frequently.



Pedestrian Recall

Recommend that the City consider implementing pedestrian recall mode to traffic signals on the High Injury Network where appropriate.

What is Pedestrian Recall and Detection?

Activating pedestrian recall mode initiates the pedestrian phase automatically with its corresponding phase for every traffic signal cycle. This means that the pedestrian would not have to push a button in order to see the "Walk" phase. This is typically implemented in areas with high levels of pedestrian activity.

Street Design Policies

Consistent with Vision Zero Action 2.1 it is recommended that the city update street design standards to reflect complete streets and designs reflective of crash reduction factors.

Based upon experience on the Top 5 corridors, some tools to consider as part of this update include the following:



Pedestrian Countdown Signals

Recommend that the City continue its efforts to install pedestrian countdown signals at all signalized intersections.

What are pedestrian countdown signals?

Per the City's draft Pedestrian Crossing Guidelines, pedestrian countdown signals are particularly useful to pedestrians at longer distance crossings, so pedestrians know how much time remains to fully cross the street before the signal changes.



Bikeway Selection

Recommend that the City install the appropriate bike facility based on the guidance in the Sacramento Bicycle Master Plan.

How are bikeways selected?

The Sacramento Bike Master Plan contains a "Bikeway Facility Selection Guidelines" chart to provide a starting point to help identify which bikeway type is appropriate for a road based on its traffic volume and speed limit. Using this chart to build appropriate bike facilities will create a low stress network that is comfortable for riders of all ages and abilities to use.



Sidewalk Widths

Recommend that the City consider a contextual approach to setting the minimum widths of sidewalks with the next update to the street design standards.

How are sidewalk widths determined?

In accordance with ADA accessibility guidelines, sidewalks should at least 5 feet in width. A contextual approach for sidewalk width setting could take into consideration the street type and surrounding land use, requiring wider sidewalks on some streets to enhance safety and comfort for pedestrians.



Lane Widths

Recommend that the City consider exemptions to the standard minimum lane width on the Top 5 Corridors and remaining High-Injury Network, where appropriate.

How are lane widths determined?

City street design standards require minimum lane widths for specific scenarios. A reduction in lane width produces a traffic calming effect by encouraging drivers to travel at slower speeds. Other considerations for setting minimum lane widths are truck routes, transit routes, and locations where adjacent lanes are in the opposite direction.

Other Policies

This section documents additional recommended policy modifications based upon experience on the Top 5 corridors:



Speed Limit Setting

Recommend that the City continue to pursue efforts to reduce posted speed limits on the HIN.

How are speed limits set?

State guidelines require surveys of current speeds to be used as the basis for speed limit setting. While continuing to operate within State guidance the City has some tools to ensure that speed limits on the HIN are context sensitive and prioritize the safety and comfort of all road users.



Speed Safety Cameras

Recommend that the City support the use of automated speed enforcement in State Legislation.

What are speed safety cameras?

Speed safety cameras are devices that can identify speeding violations and issue citations. This type of speed enforcement is allowed in many States, it is not allowed in California. The City of Sacramento should continue to support legislative efforts to allow speed safety cameras in California.



Bus Stop Placement and Supportive Facilities

Recommend that the City prioritize pedestrian and bike safety improvements that provide connections to light rail stations and bus stops. At minimum, bus stops should be co-located with an adjacent crosswalk (within 100 feet).

How are bus stop placements determined?

Consistent with the City's draft Pedestrian Crossing Guidelines, recommend that bus stops are placed on the far side of intersections and downstream of adjacent crosswalks, to ensure bus stop does not conflict with crosswalk approach. Recommend that the City also provide adequate sidewalk width on streets with bus routes to provide stop amenities while maintaining space for pedestrian flow.

Newly Adopted or In Process Policies



Complete Streets Policy

In December 2019, the City adopted a Complete Streets Policy to promote safe and convenient travel options on Sacramento's streets for all users of all abilities and ages.

This policy aligns with and supports projects and policies recommended as part of this report, as well as the Action Items listed in the Sacramento Vision Zero Action Plan.



Pedestrian Crossing Guidelines

Recommend that the City update the Pedestrian Crossing Guidelines later this year. The updated guidelines, currently in draft form, will include recommendations related to crosswalk spacing, markings, and safety enhancement facilities.

Key considerations included in the draft Guidelines support the crosswalk safety enhancement recommended in this report. Additionally, marked crosswalk spacing is recommended at least as frequently as shown below:

- Every 800 feet on the Grid
- Every 1,200 feet on the HIN
- Within 100 feet of new transit stops

Vision **ZERO**

TOP 5 CORRIDORS





TOP 5 CORRIDORS

Vision
ZERO



El Cammino

Vision Zero
Top 5 Corridor

El Camino Avenue

Vision Zero Top 5 Corridor



El Camino Ave & Del Paso Blvd

What is going on?

Between 2009 and 2017, 11 crashes that resulted in a fatality or severe injury (KSI) occurred on the segment of El Camino Avenue between Ueda Parkway and Del Paso Boulevard, three of which involved a pedestrian.

What are the key issues?

Many of the vehicular crashes involved rear-ends, proceeding straight, and driving at an unsafe speed. Additionally, two-thirds of pedestrian crashes involved people crossing the street in a marked crosswalk.

What is the community concerned about?

During outreach, residents spoke of drivers traveling too fast on the corridor, which can make it difficult to cross the street or pull out of driveways.

The following pages lay out the existing conditions along the corridor, feedback heard from residents at outreach events, and roadway safety recommendations focused on reducing vehicle speed, improving visibility, increasing compliance with signals and signs, and providing additional crossing opportunities for pedestrians.

Table of Contents

A-4

**In the
Neighborhood**

A-6

**Travel on
El Camino**

A-8

**Safety on
El Camino**

A-10

**Feedback from
the Community**

A-11

**Investments to
Enhance Safety**

A-12

**Conceptual Design
for El Camino**

A-26

**How Will Travel
Change?**

A-28

**How Much Will
the Project Cost?**

In the Neighborhood

Corridor



About the Neighborhood

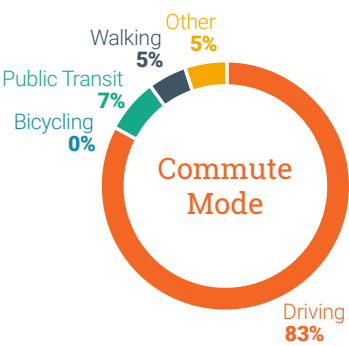

Residents in this neighborhood take transit and walk to work at a higher rate than the City as a whole.

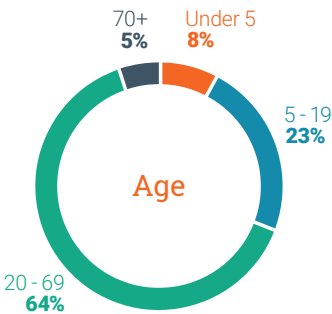

This neighborhood has a higher share of residents age 5-19 than the City as a whole.

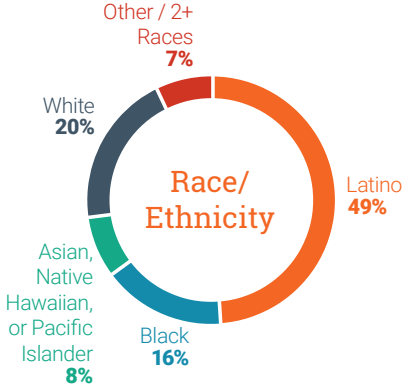

65% of the residents in this neighborhood are Black or Latino, compared with 42% citywide.



Key Destinations Along the Corridor

Parks



Regional Trails



Libraries



Food Markets



Houses of Worship



Travel on El Camino

Key Statistics

Posted Speed Limit

30
MPH

Daily Vehicles

13,500

Maximum PM Intersection Vehicle Volume

1,288

PM Rush Hour People Walking

151

PM Rush Hour People Biking

158

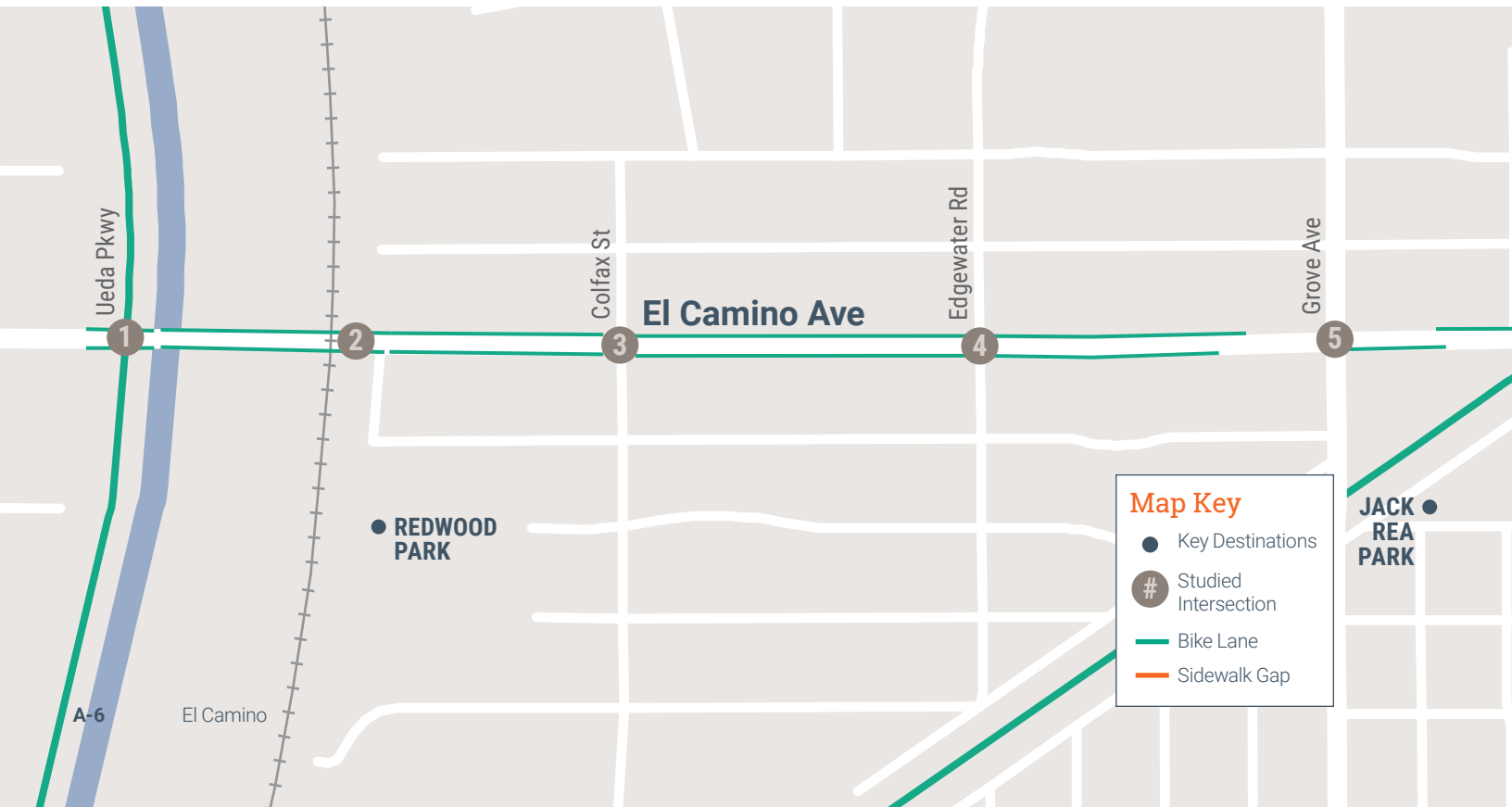
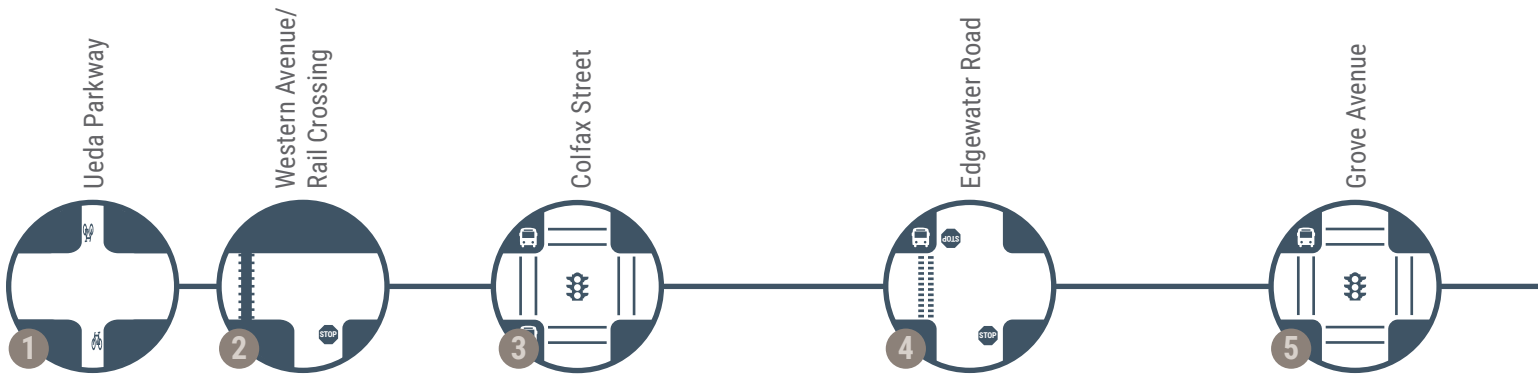

Map Key

- Key Destinations
- ⊕ Studied Intersection
- Bike Lane
- Sidewalk Gap

Number of
Transit Routes

2
#15, #88

Bikeway
Type

**On-Street
Bike Lanes
with gaps**

Longest Distance
Between Marked
Crosswalks

2,100
Ft

Sidewalk
Coverage

97%

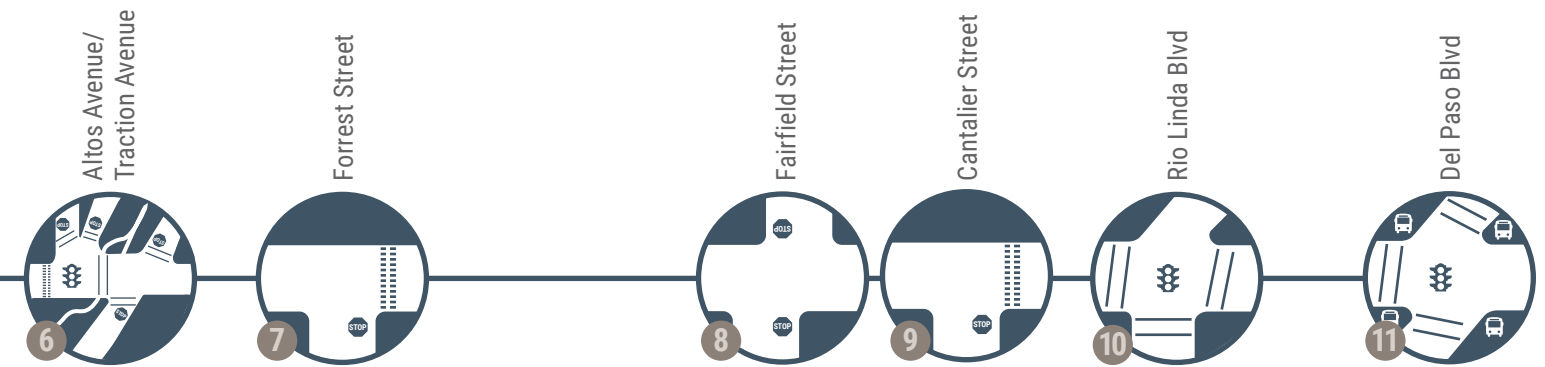

Crashes on El Camino

Vehicle Crash Types

Unsafe Speed

"Unsafe Speed" was the most common violation, cited in 40% of all crashes.

1 2 3 4 5 6
7 8 9 10 11

Proceeding Straight

80% of drivers were proceeding straight or stopped at the time of the crash.

1 2 3 4 5 6
7 8 9 10 11

Rear End

Over 40% of all crashes were rear end.

1 2 3 4 5 6
7 8 9 10 11

Crash Locations

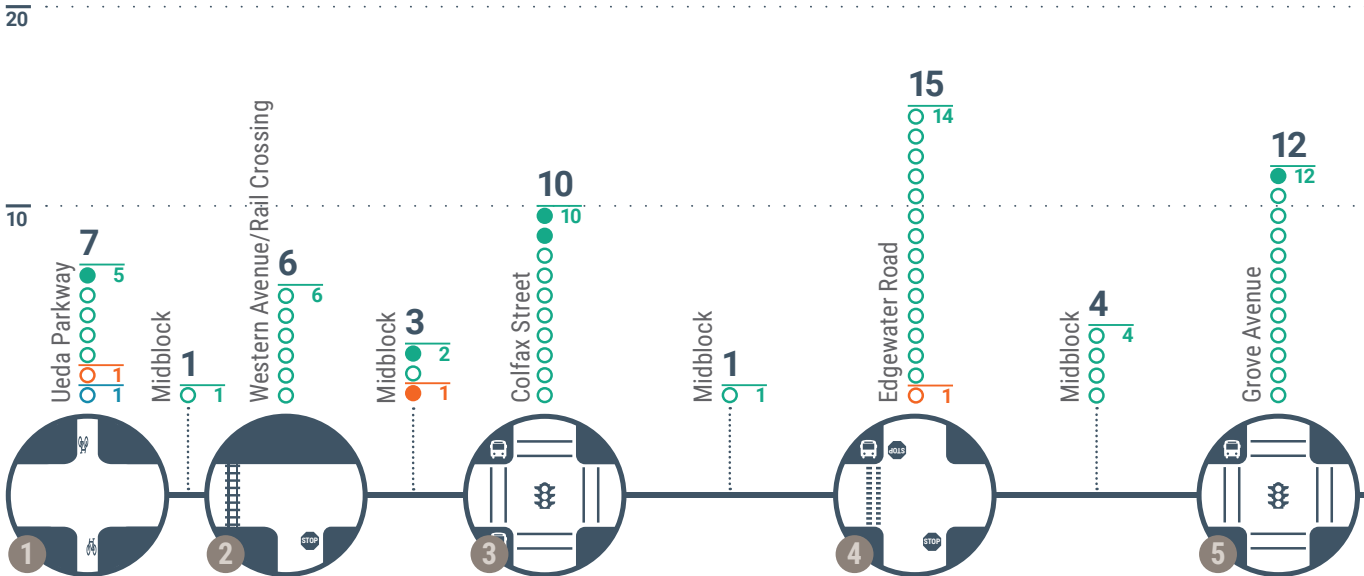

Pedestrian Crash Types

Bike Crash Types

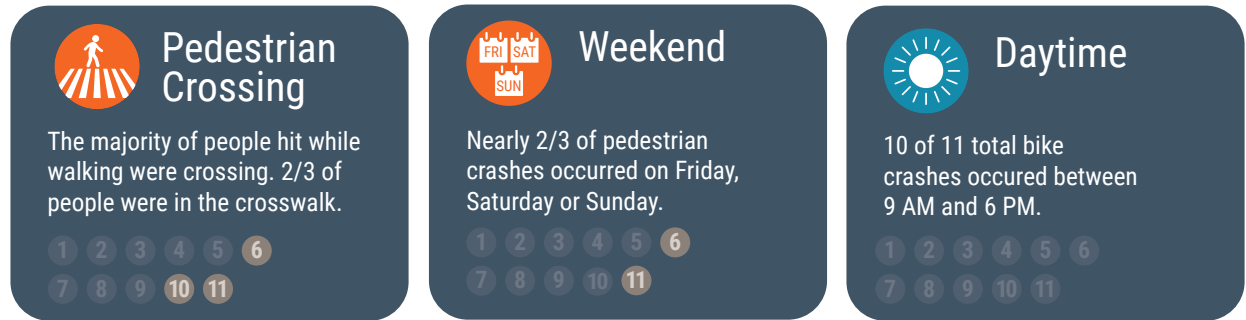

1 Numbers that are turned on represent a location where crash type has occurred at least three times.

Total Crashes	
	Fatal and Severe Crashes
All Injury Crashes	8
Vehicle	117
Pedestrian	3
Bike	0

*One crash involved both a pedestrian and bicyclist and is identified under both mode categories

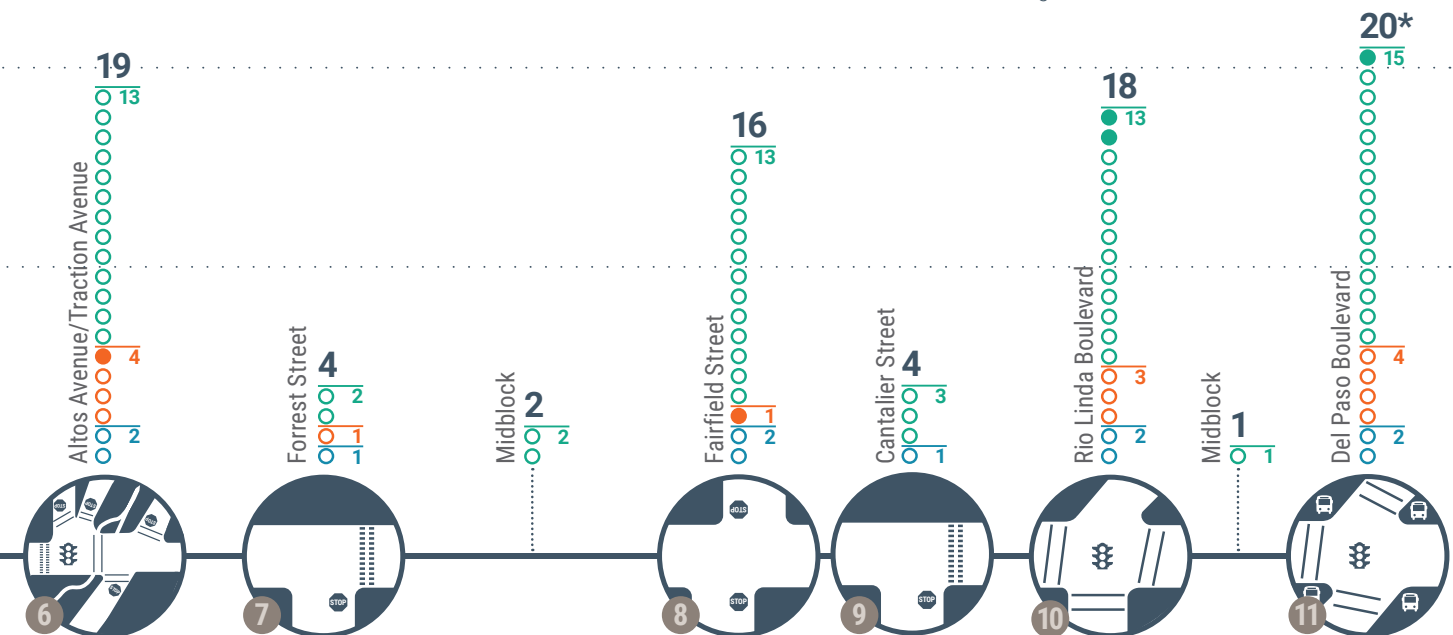

Feedback from the Community

“ At the intersection of Del Paso and El Camino, it is hard to cross the street.”

“ A lot of homes have their driveways backing into El Camino—there is unsafe backing out due to high speeds and visibility issues.”



Grocery Outlet Store Pop-Up Event

Key Themes

Visibility

Residents provided feedback related to nighttime visibility issues due to insufficient lighting, and difficulty turning onto El Camino from driveways and side streets due to sight line issues.

Signals/Signage

Residents described drivers often running red lights and pedestrians crossing against the light - both behaviors theorized to be because of long traffic signal cycle lengths.

Crossings

Residents described difficulty in crossing the street at the El Camino/Del Paso intersection due to long distances, long waits, and a missing marked crosswalk.

Speed

Residents described drivers traveling at speeds they felt were too fast, which makes driving and walking along and crossing El Camino feel uncomfortable for them.

Bike Safety

Residents provided feedback that the existing bike lanes are too narrow and often obstructed, and that fast-moving vehicle traffic makes biking uncomfortable.

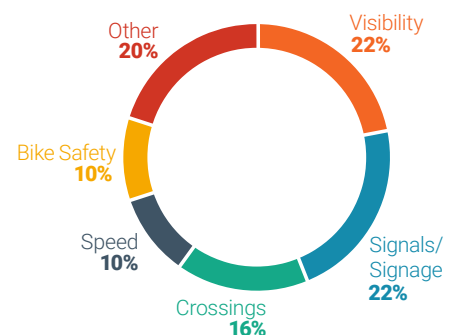

Engagement Events

November 10, 2018

Old North Sacramento / Dixieanne Community Association Meeting

December 4, 2018









Grocery Outlet Store Pop-Up Event

June 6, 2019

Greater Sacramento Urban League Open House Event

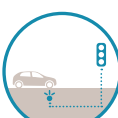
Investments to Enhance Safety

Key Crash Countermeasures

Countermeasure	Crash Type	Feedback Key Theme
 <p>Slow Green Wave</p> <p>TO ADDRESS</p>	 <p>Unsafe Speed</p>	Speed
 <p>Add New Signal</p> <p>TO ADDRESS</p>	 <p>Pedestrian Crossing</p>	Visibility
 <p>Advanced Dilemma-Zone Detection</p> <p>TO ADDRESS</p>	 <p>Rear End</p>	Signals/Signage
 <p>Pedestrian Scramble</p> <p>TO ADDRESS</p>	 <p>Pedestrian Crossing</p>	Crossings



El Camino Avenue at Traction Avenue

Conceptual Design for El Camino

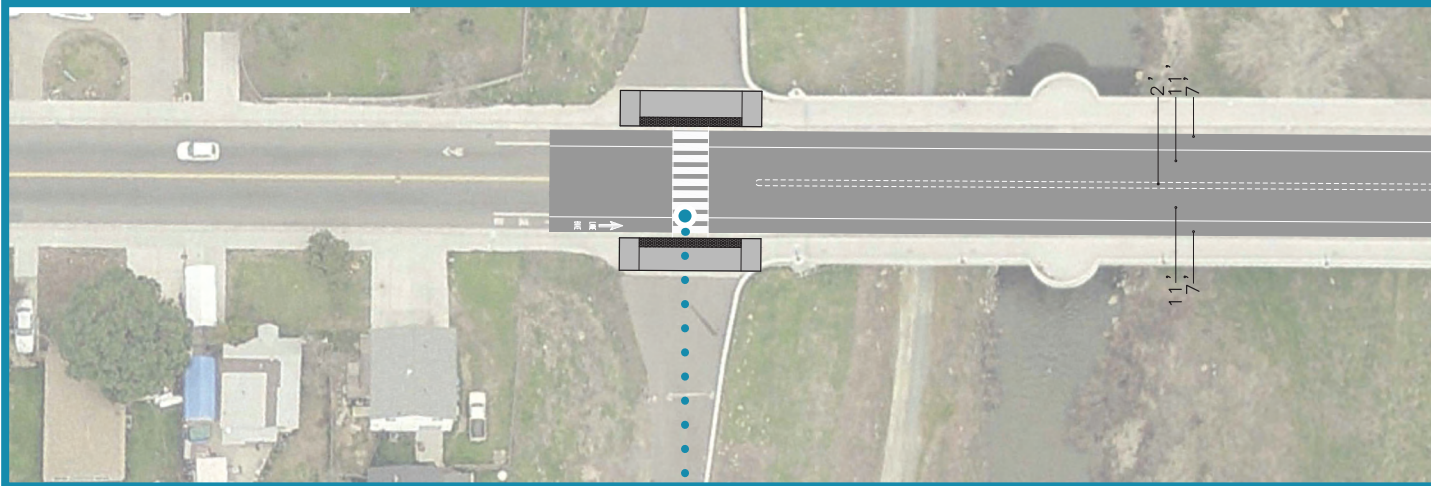

New Pedestrian Signal



Pedestrian Scale Lighting



Narrow Lanes



Slow Green Wave



Pedestrian Recall Signal Timing

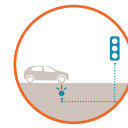

Advanced Dilemma-Zone Detection



High Visibility Crosswalk

Corridor-Wide Recommendations

Location-Specific Recommendations

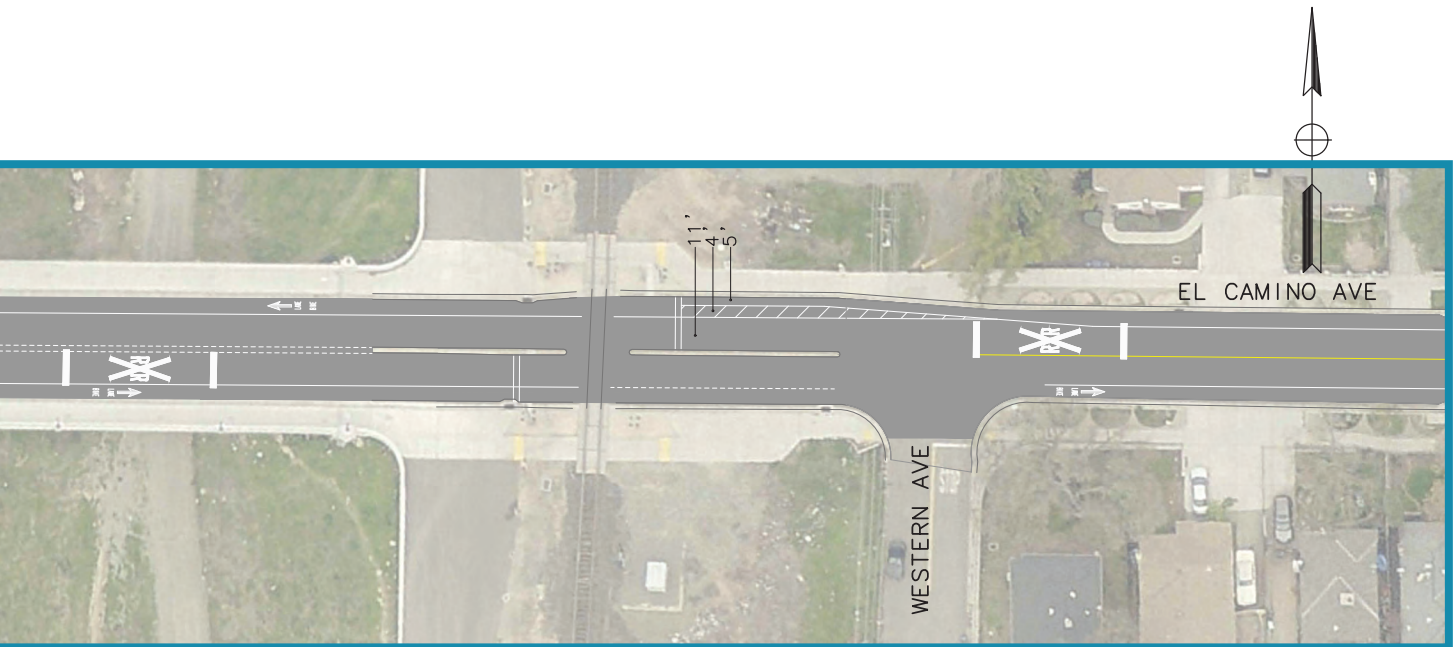

Note: Maintain existing 10 foot travel lanes on El Camino Avenue

Conceptual Design for El Camino



Shorten Signal
Cycle Length



Pedestrian Scale Lighting



Narrow Lanes



Slow Green Wave



Pedestrian Recall Signal Timing

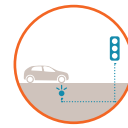

Advanced Dilemma-Zone Detection



High Visibility Crosswalk

Corridor-Wide Recommendations

Location-Specific Recommendations



Conceptual Design for El Camino

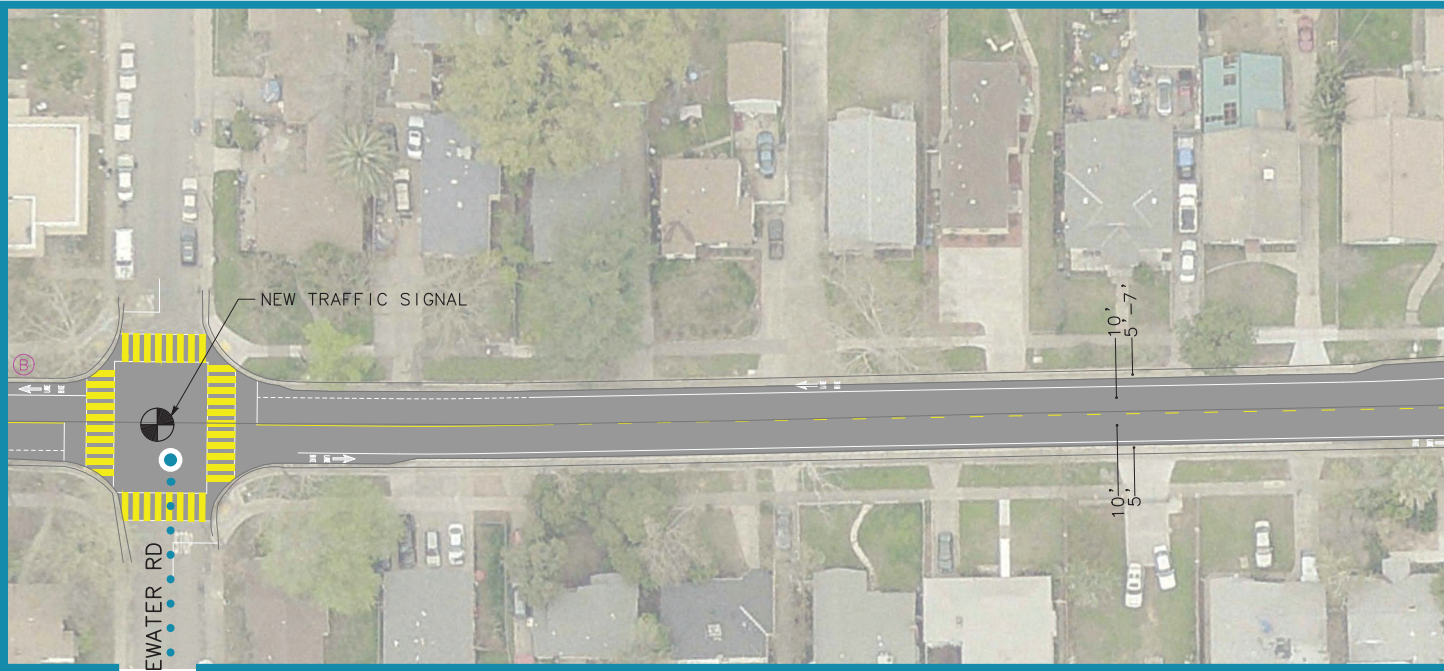



Pedestrian Scale Lighting



Narrow Lanes



Slow Green Wave



Pedestrian Recall Signal Timing

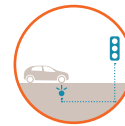

Advanced Dilemma-Zone Detection



High Visibility Crosswalk

Corridor-Wide Recommendations

Location-Specific Recommendations

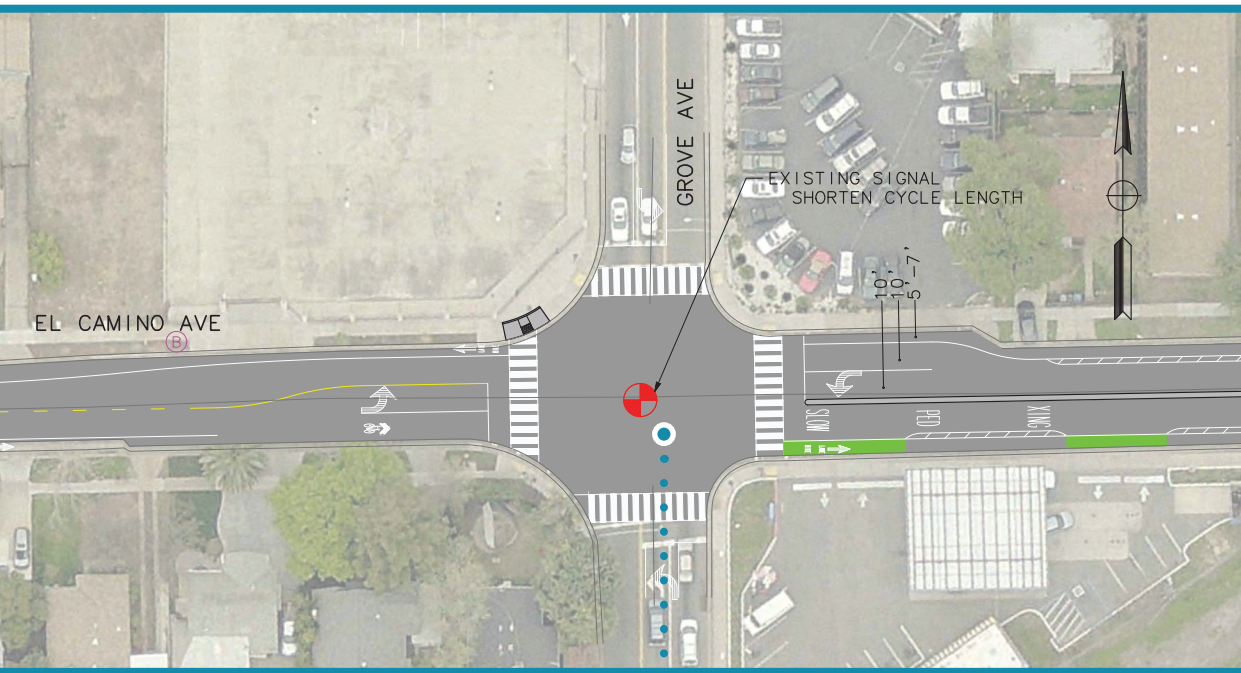

Shorten Signal Cycle Length



Raised Median

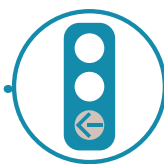

Protected Left Turns

Conceptual Design for El Camino

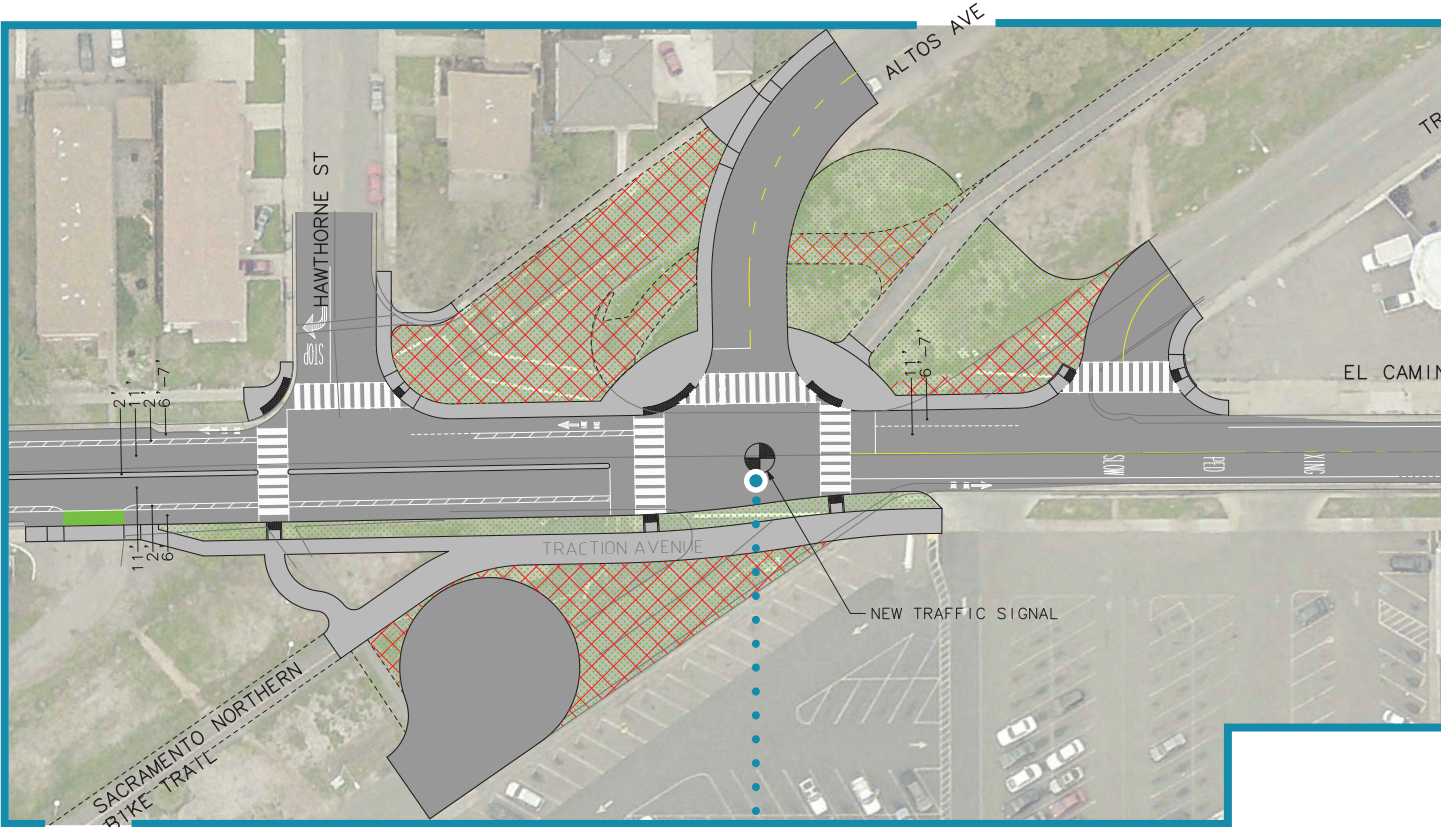

Close Bike Lane Gap

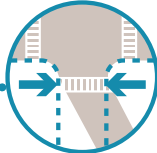

Realign Intersection to 90 Degrees



Road Closure



New Traffic Signal

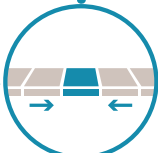

Close Sidewalk Gap

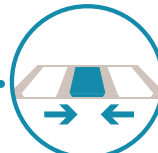

Consolidate Driveways



Pedestrian Scale Lighting



Narrow Lanes



Slow Green Wave



Pedestrian Recall Signal Timing

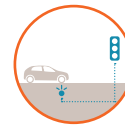

Advanced Dilemma-Zone Detection



High Visibility Crosswalk

Corridor-Wide Recommendations

Location-Specific Recommendations

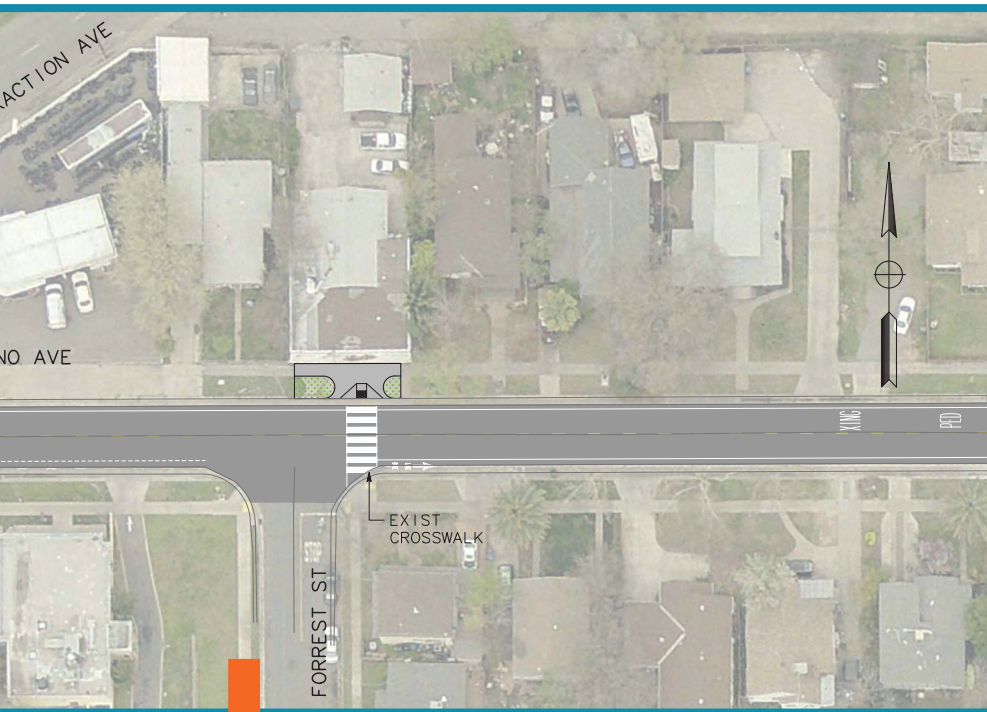

Project Options

Option 1: Close south leg of Traction Ave, north leg of Traction Ave, south leg of Altos Ave, and Hawthorne Ave is right-in/right-out only. Square up north leg of Altos Ave and install a traffic signal.

Option 2: Close north leg of Traction and south leg of Altos Ave. Hawthorne Ave is right-in/right-out. Square up north leg of Altos Ave and south leg of Traction Ave. Install raised intersection and traffic signal with pedestrian scramble to serve bike and pedestrian traffic using Sacramento North Bike Trail. This option is shown in the concept plans.

Conceptual Design for El Camino





Pedestrian Scale Lighting



Narrow Lanes



Slow Green Wave



Pedestrian Recall Signal Timing

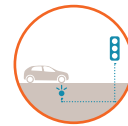

Advanced Dilemma-Zone Detection



High Visibility Crosswalk

Corridor-Wide Recommendations

Location-Specific Recommendations

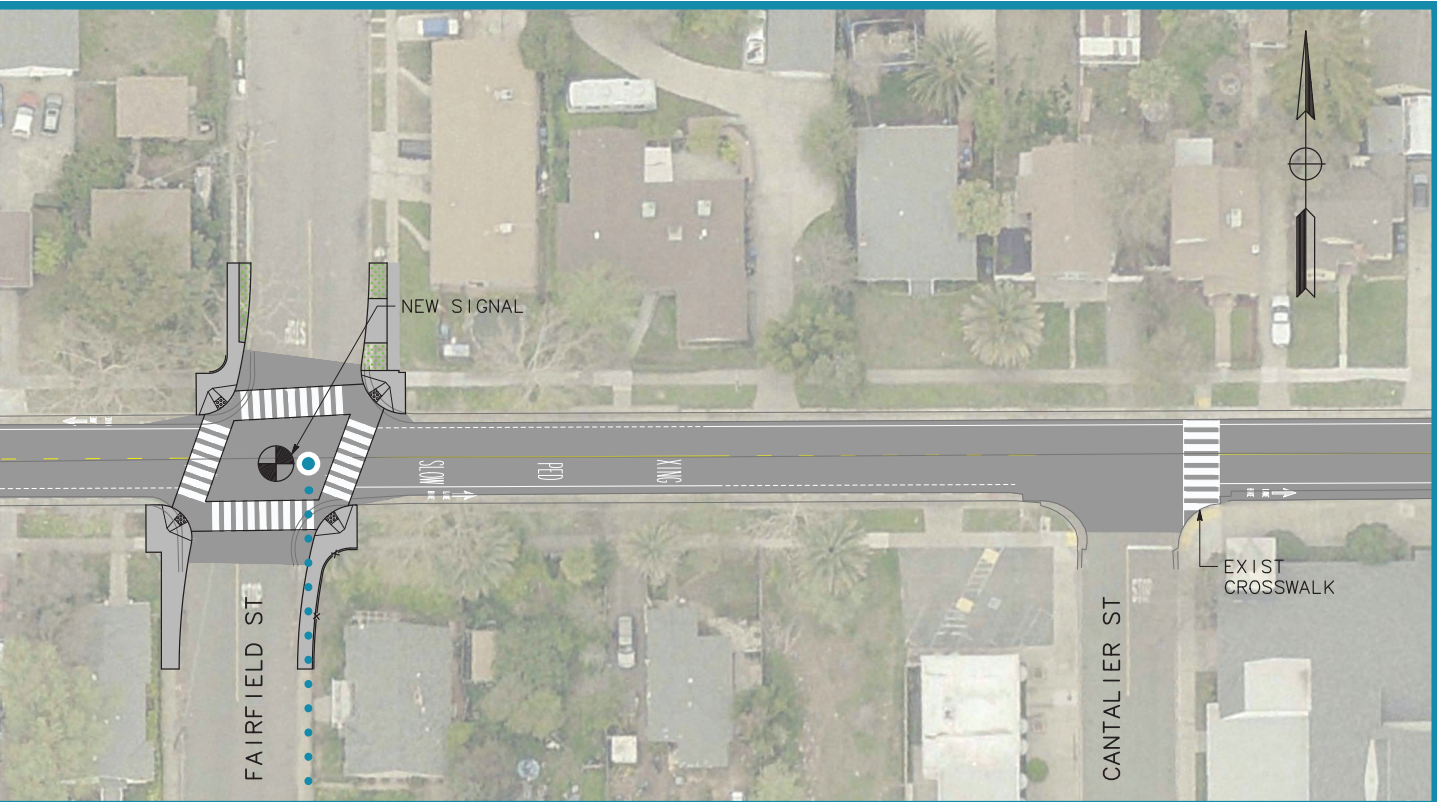

New Traffic Signal

Conceptual Design for El Camino



Pedestrian Scale Lighting



Narrow Lanes



Slow Green Wave



Pedestrian Recall Signal Timing

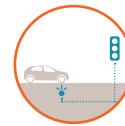

Advanced Dilemma-Zone Detection



High Visibility Crosswalk

Corridor-Wide Recommendations

Location-Specific Recommendations

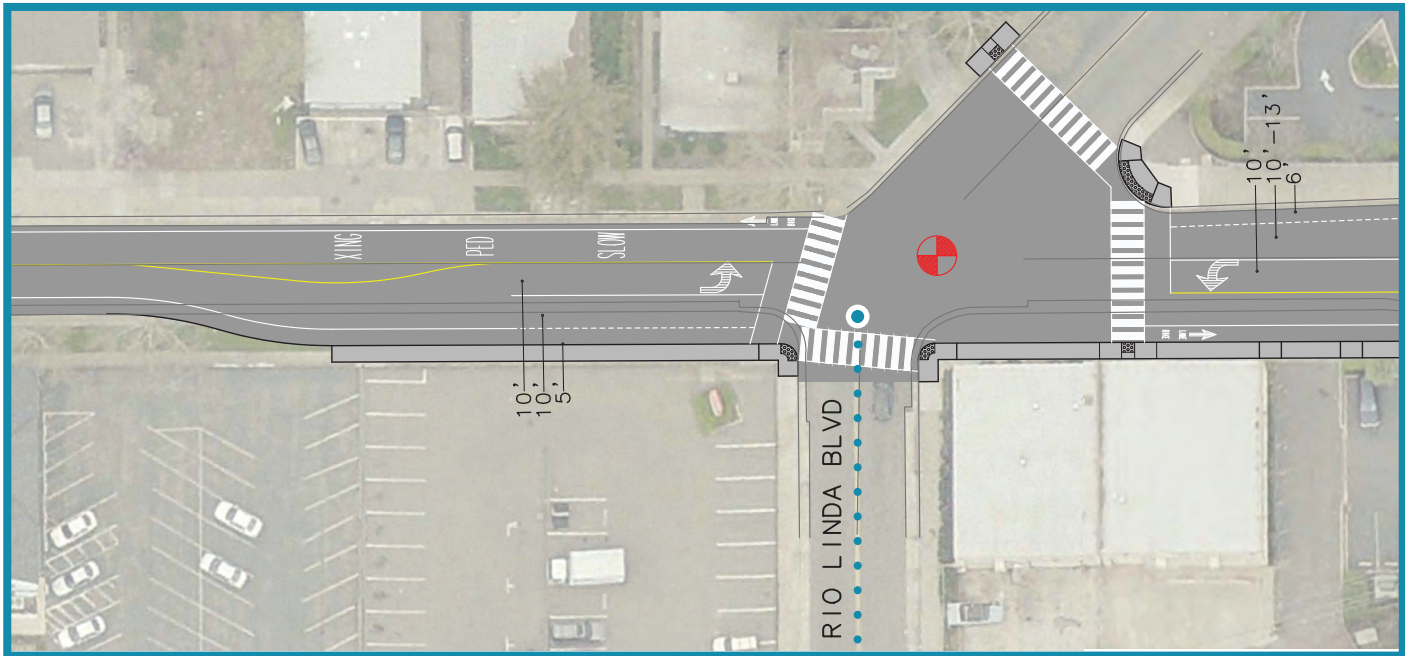

Dual Curb Ramps



Extend Signal Clearance Time



Straighten Crosswalk

Conceptual Design for El Camino

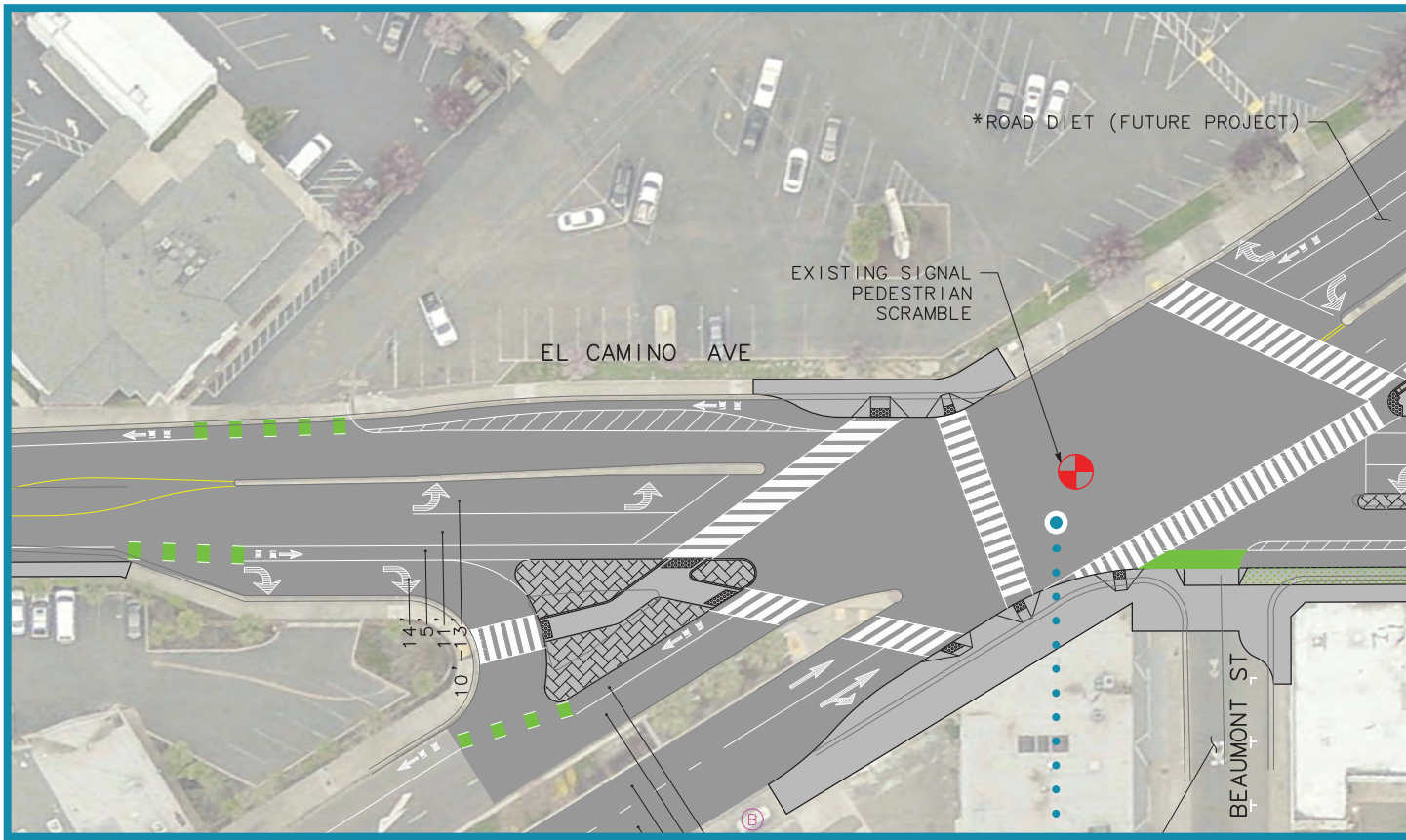

* The Del Paso Boulevard Road Diet is not a part of the Top 5 Corridors Plan

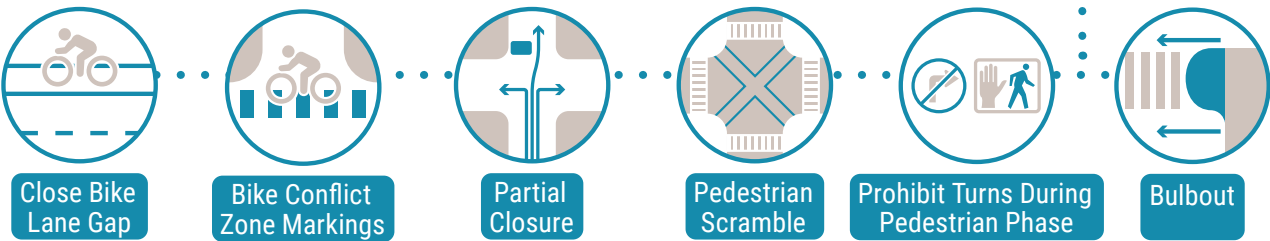



Pedestrian Scale Lighting



Narrow Lanes



Slow Green Wave



Pedestrian Recall Signal Timing

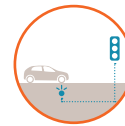

Advanced Dilemma-Zone Detection



High Visibility Crosswalk

Corridor-Wide Recommendations

Location-Specific Recommendations



El Camino Avenue/Del Paso Boulevard/Beaumont Street Queues

El Camino Avenue is a two-lane, 30-miles-per-hour roadway for most of the study corridor, but east of Del Paso Boulevard, it widens to four-lanes and the posted speed limit increases to 35-miles per hour. It provides an east-west connection over Steelhead Creek and to I-80 Business Loop. As a result, the El Camino Avenue/Del Paso Boulevard/Beaumont Street intersection is very busy. Conditions may be exacerbated with the Vision Zero recommended road diet on Del Paso Boulevard. According to the City's General Plan, the intersection is exempt from the City's LOS D standard and can operate at LOS E conditions during peak hours acceptably.

How Will Travel Change?

Estimated Changes with Project

Average Vehicle Speed

Average vehicle speed along the corridor during peak periods is expected to decrease between 2 and 5 mph as a result of the proposed project. While slower travel speeds result in longer travel times, they reduce traffic fatalities and severe injuries that result from crashes. Additionally, the new traffic signals will create gaps in traffic that will improve access from side-streets and driveways.

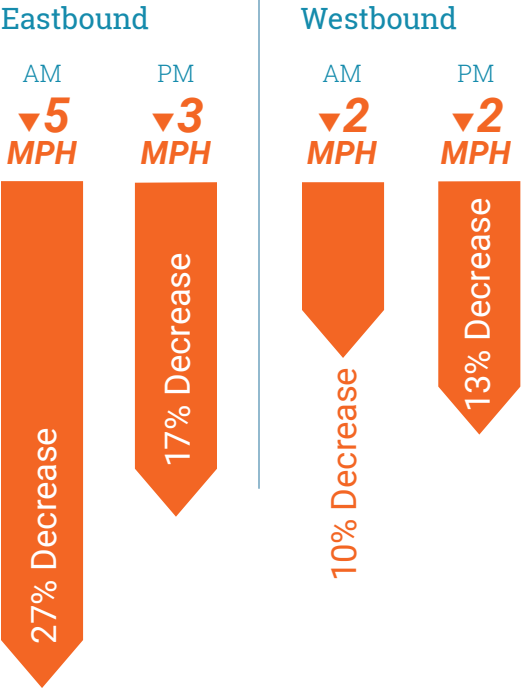

Vehicle Travel Time

Average vehicle travel time along the one-mile corridor during peak periods is expected to increase between 31 and 84 seconds as a result of the proposed project.

Estimated Changes with Project

Sidewalk Coverage

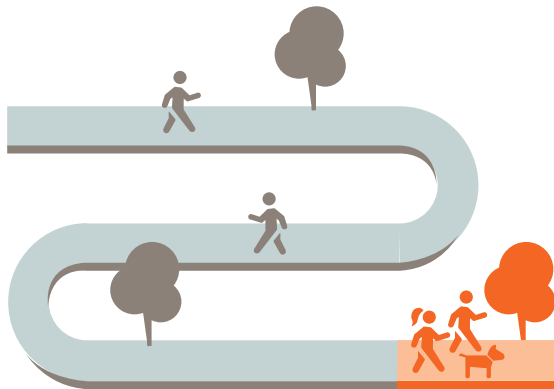

Without project
97%
(12,150 ft)

▶

With project
100%
(12,500 ft)

Bike Lane Coverage

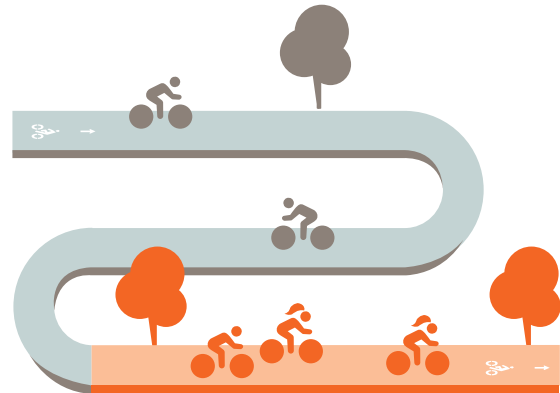

Without project
69%
(8,580 ft)

▶

With project
100%
(12,500 ft)

Number of Locations Upgraded to Controlled Crossings

3

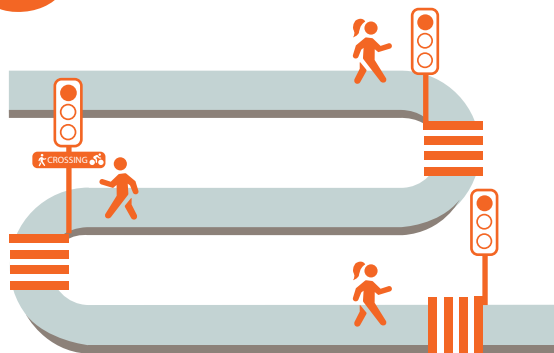

Number of Marked Crosswalks

10 *new crossings*

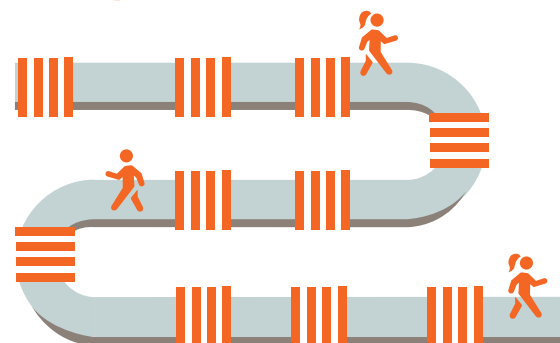

How Much Will the Project Cost?

El Camino Avenue Cost Summary

\$16,450,000

Construction

Construction costs include the cost to build the primary items associated with the safety countermeasures for the corridor. The items were estimated based on the preliminary design concepts and recent construction bid unit costs with an escalation factor to account for future construction. The costs were broken down into two categories that consisted of major roadway items and electrical items such as traffic signals and lighting. A contingency factor was included to account for refinement of project design, changes in project details, or unforeseen changes in construction costs.

Actual project costs will be determined by surveyed base mapping, geotechnical reports, concept refinement, environmental reviews, right of way availability, project phasing, and bid conditions at the time of advertisement. Project costs should be reviewed prior to any grant application or initiation of a Capital Improvement Project to revalidate and update the assumptions in this study as necessary.

Right of Way

In addition to construction costs, right of way costs were assumed that include temporary construction easements for items such driveway modifications, curb ramps reconstruction, signal equipment poles and cabinets. It was assumed that each project could be constructed almost exclusively within the roadway prism and right of way acquisition would not be needed along the entire project frontage. Further refinement of the base mapping in subsequent phases of design will more accurately identify specific right of way needs.

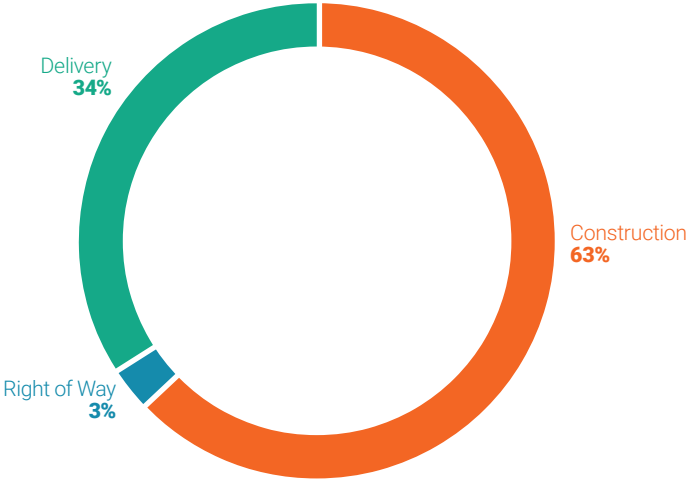

The total project costs shown in the summary chart have been escalated at an assumed 3% per year escalation factor to 2025, the anticipated year of construction.

Delivery

Project delivery costs are included in the estimates provided in this study. These costs encompass all of the work to complete subsequent phases including preliminary engineering, environmental documentation, final design, right of way engineering, and construction oversight. A breakdown of these costs is provided in Appendix C.



Marysville

Vision Zero
Top 5 Corridor

Marysville Boulevard south of North Avenue

Marysville Boulevard

Vision Zero Top 5 Corridor

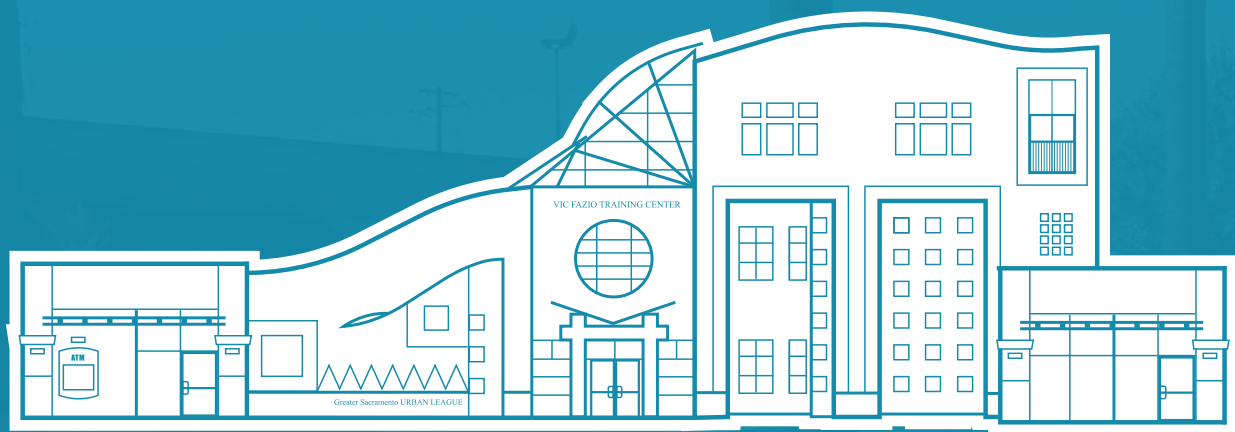

Marysville Blvd - Greater Sacramento Urban League/Vic Fazio Training Center

What is going on?

Between 2009 and 2017, 19 crashes that resulted in a fatality or severe injury (KSI) occurred on Marysville Boulevard between North Avenue and Arcade Boulevard. Three of these crashes involved a bicyclist and 11 of the crashes involved a pedestrian.

What are the key issues?

Two-thirds of drivers were proceeding straight or stopped at the time of the crash, and alcohol was involved in over half the crashes that resulted in a KSI. Additionally, two thirds of pedestrian crashes involved a person crossing the street in a marked crosswalk, and three-fourths of bike crashes were broadside, or T-Bone, crashes.

What is the community concerned about?

During outreach events, local residents talked about aggressive driving behaviors that included driving at an unsafe speed and lack of attention paid to crossing pedestrians. Residents also described the difficulty crossing the street as a pedestrian because there are not enough marked crosswalks on the corridor.

The following pages lay out the existing conditions along the corridor, feedback heard from residents at outreach events, and a set of roadway safety recommendations focused on slowing drivers down and discouraging traffic signal/sign violations as well as providing more opportunities for pedestrians to cross the street at controlled, marked crossings.

Table of Contents

B-4

**In the
Neighborhood**

B-6

**Travel on
Marysville**

B-8

**Safety on
Marysville**

B-10

**Feedback from
the Community**

B-11

**Investments to
Enhance Safety**

B-12

**Conceptual Design
for Marysville**

B-22

**How Will Travel
Change?**

B-24

**How Much Will
the Project Cost?**

In the Neighborhood

Corridor



About the Neighborhood

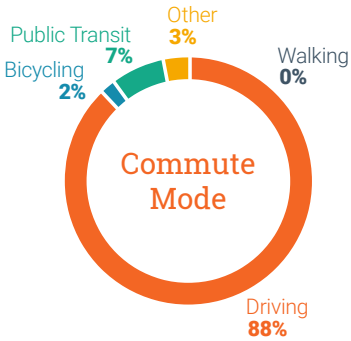

Residents of this neighborhood are more likely to take transit, but less likely to walk to work, when compared with the rest of the city.

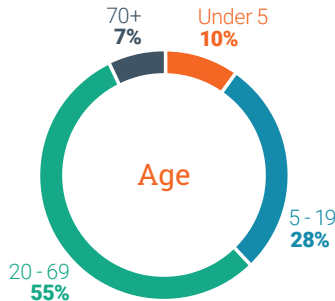

Nearly 40% of the residents in this neighborhood are age 19 or under.

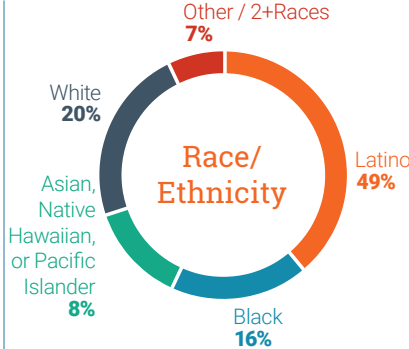

57% of the residents in this neighborhood are Black or Latino, compared with 42% citywide.



Key Destinations Along the Corridor

Parks



Schools



Food Markets



Houses of Worship



Community Centers



Travel on Marysville

Key Statistics

Posted Speed Limit

35
MPH

Daily Vehicles

26,300

Maximum PM Intersection Vehicle Volume

2,071

PM Rush Hour People Walking

201

PM Rush Hour People Biking

98

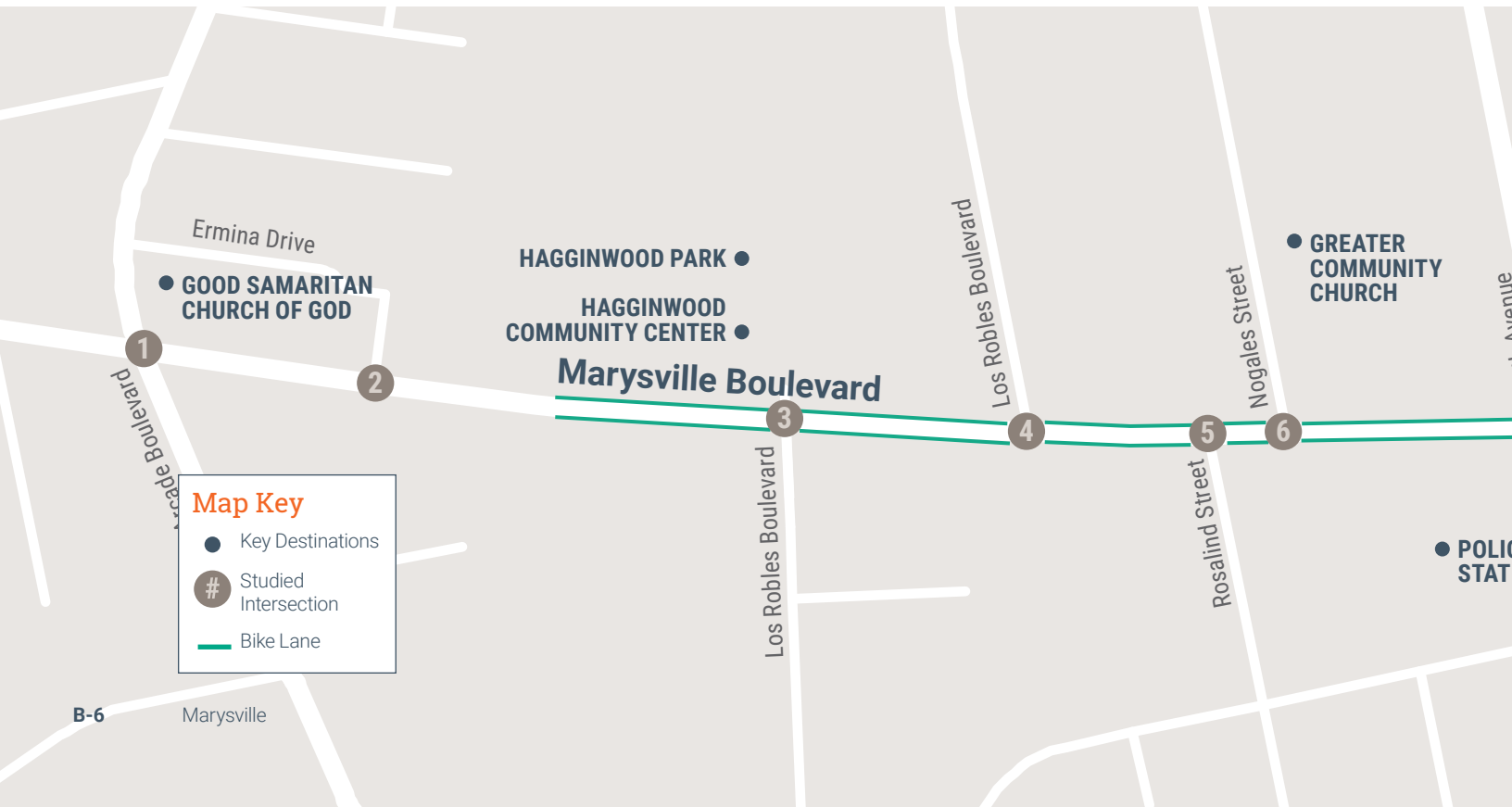
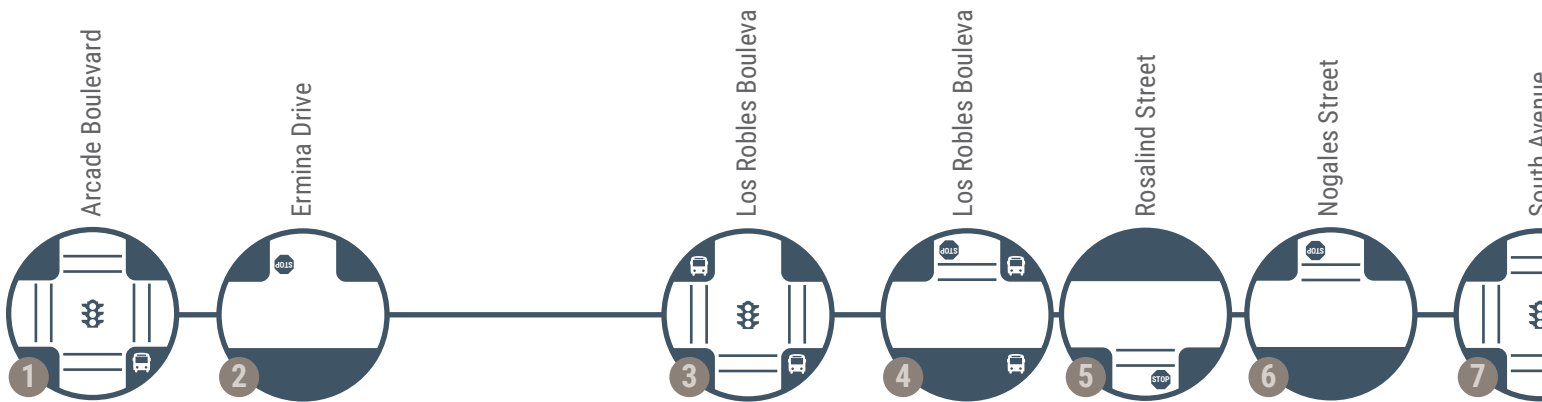

Number of
Transit Routes

2
#15, #86

Bikeway
Type

**On-Street
Bike Lanes,
with gap**

Longest Distance
Between Marked
Crosswalks

2,550
Ft

Sidewalk
Coverage

100%

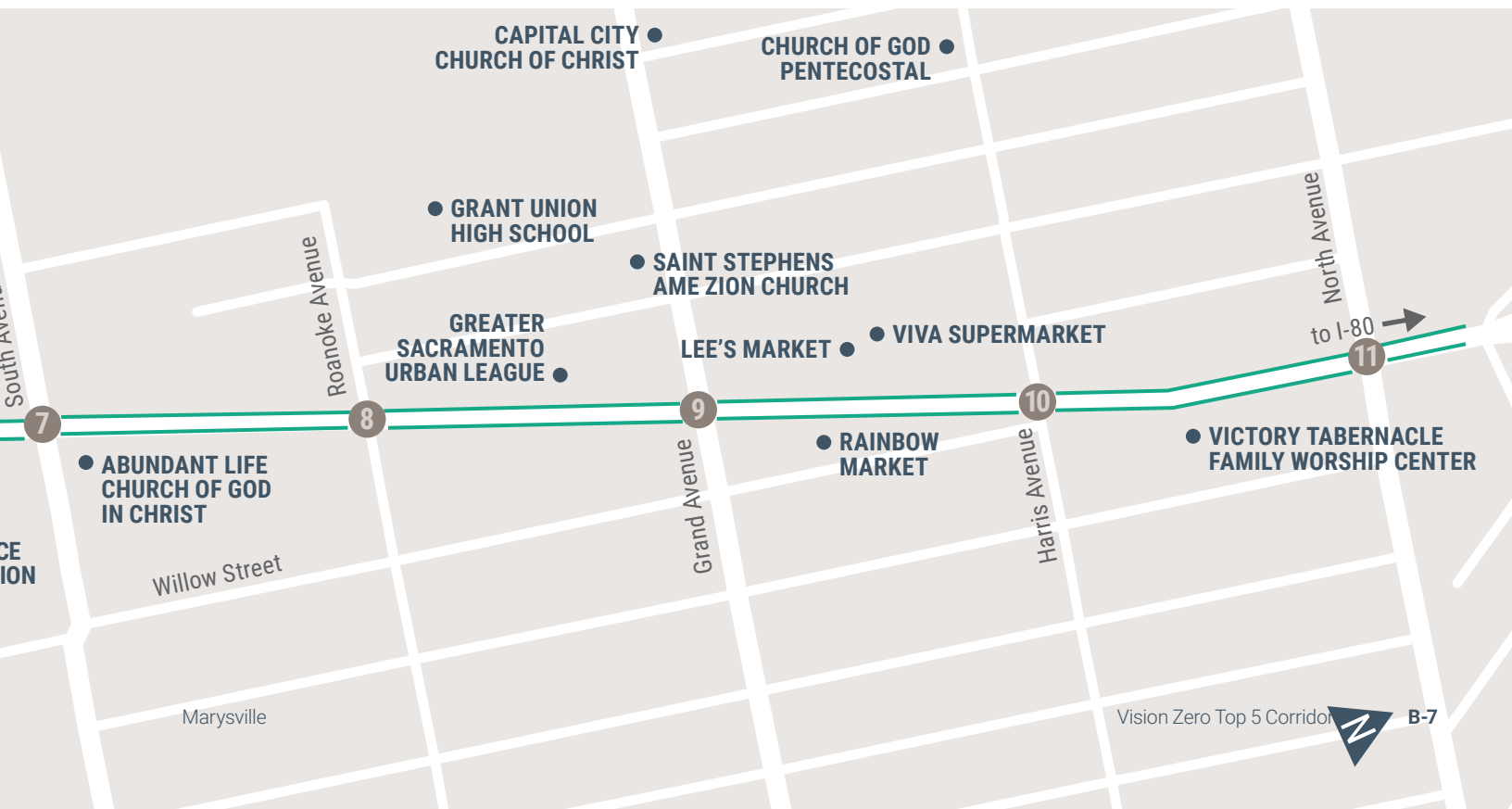
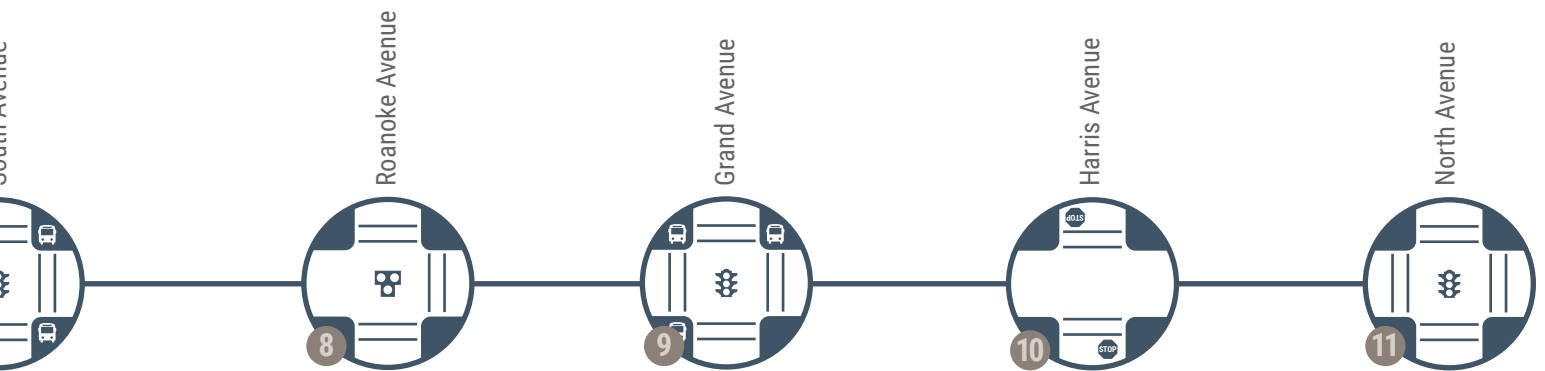

Crashes on Marysville

Vehicle Crash Types

Proceeding Straight

2/3 of drivers were proceeding straight or stopped at the time of the crash.

1 2 3 4 5 6
7 8 9 10 11

Left Turns

More than 20% of drivers were making a left turn at the time of the crash.

1 2 3 4 5 6
7 8 9 10 11

Broadside

40% of all crashes were broadside, also called T-Bone.

1 2 3 4 5 6
7 8 9 10 11

Crash Locations

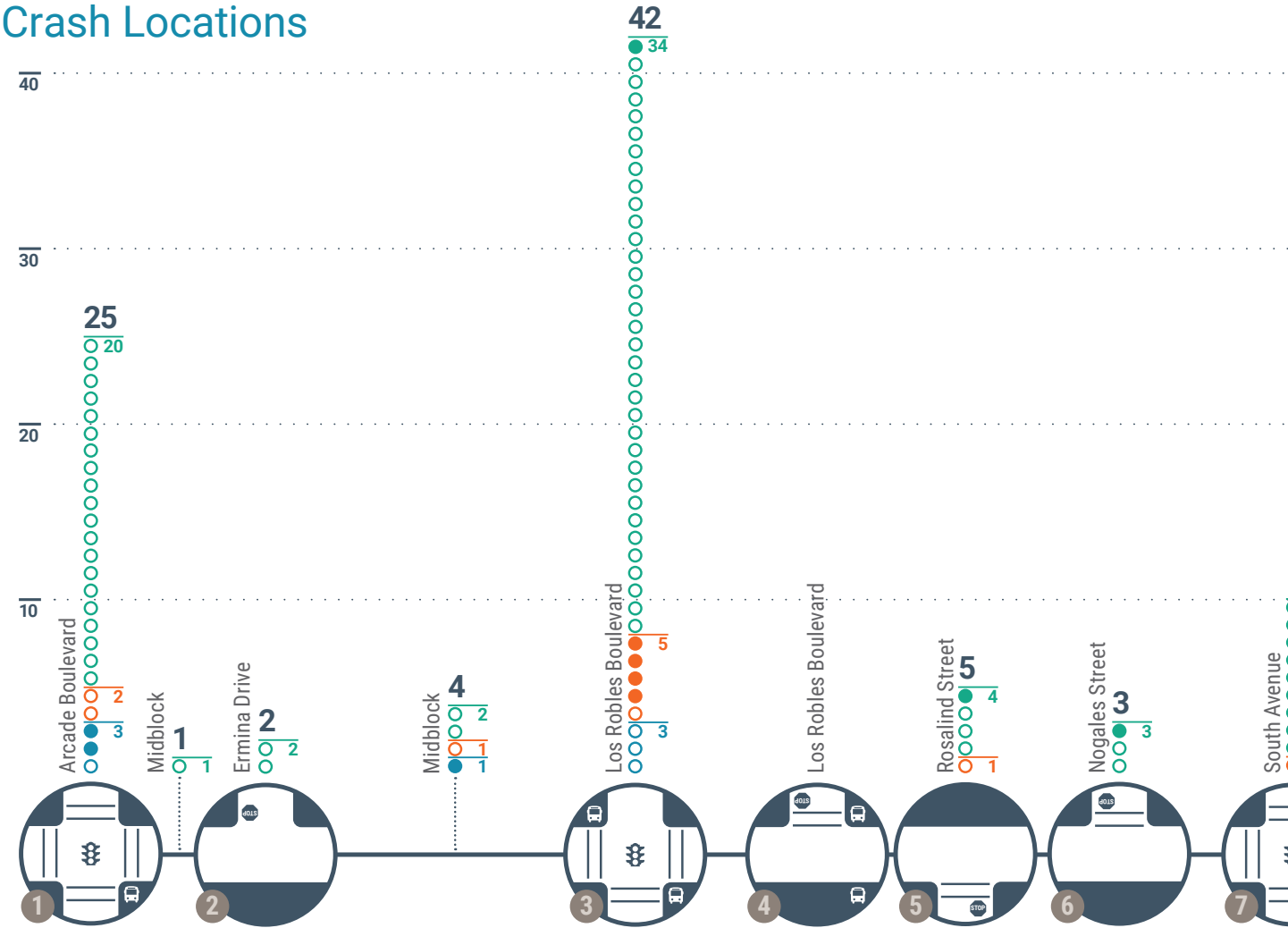

Ped Crash Types

Bike Crash Types

KSI & Alcohol Involved

Alcohol was involved in over half of crashes resulting in a fatality or severe injury.

1 2 **3** 4 5 6
7 8 9 10 11

Pedestrian Crossing

Almost all people hit while walking were crossing. 2/3 of people were in the crosswalk.

1 2 **3** 4 5 6
7 8 9 10 11

Broadside

3/4 of bike crashes were broadside, also called T-Bone.

1 2 3 4 5 6
7 8 **9** 10 11

1 Numbers that are turned on represent a location where crash type has occurred at least three times.

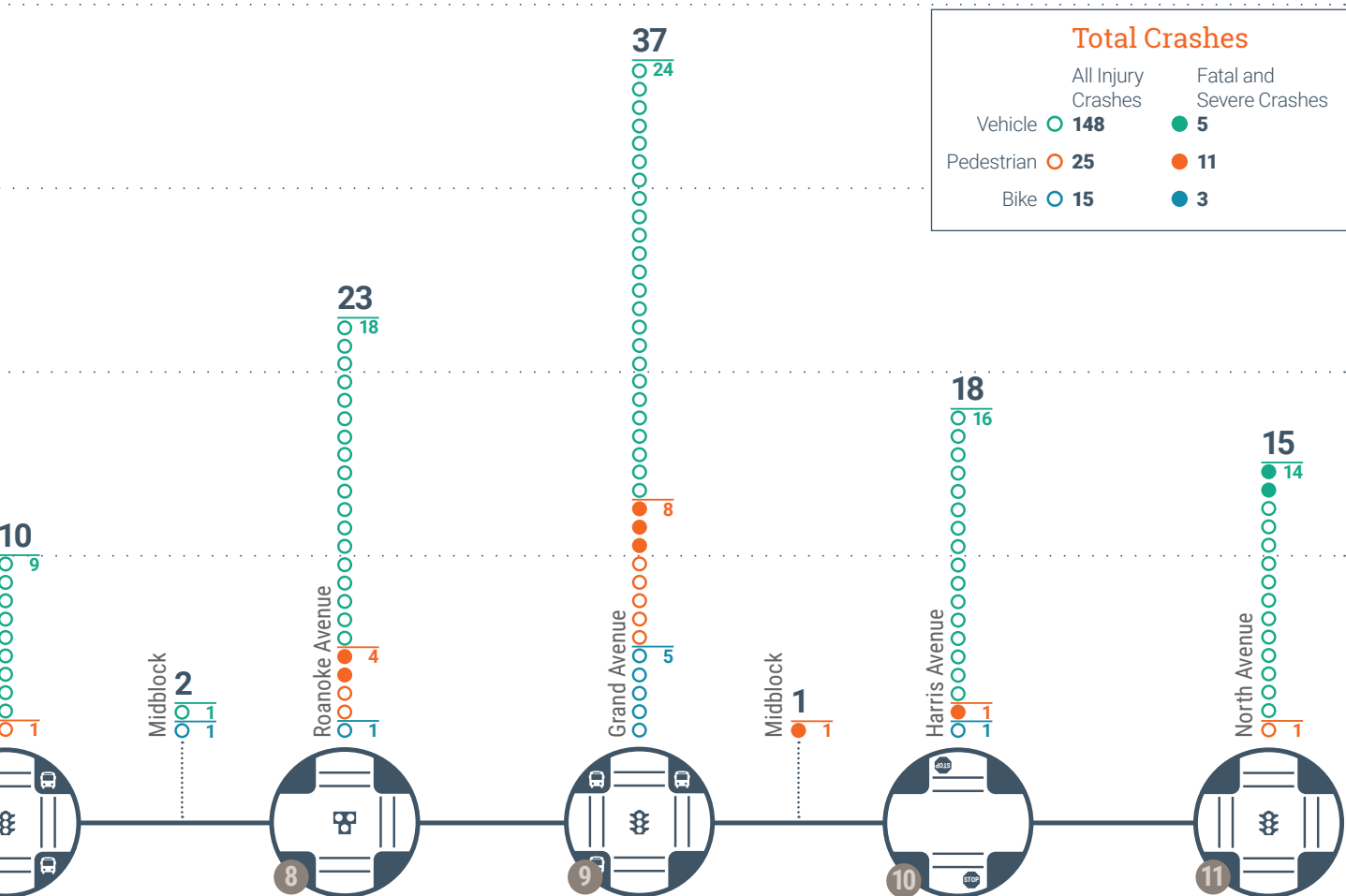

Feedback from the Community

“Slow down traffic, drivers go over 35 MPH.”

“More signals and more crosswalks would make Marysville safer.”



Mutual Assistance Harvest Festival

Key Themes

Visibility

Residents described visibility issues due to skew of intersections and presence of sight obstructions.

Signals/Signage

Residents suggested that more signals or flashing beacons could make it safer for pedestrians to cross the street.

Crossings

Residents described difficulty in crossing the street as a pedestrian because crosswalks are located far apart, and drivers do not pay attention to their presence.

Speed

Residents described drivers traveling at speeds they felt were too fast and driving aggressively along Marysville Boulevard.

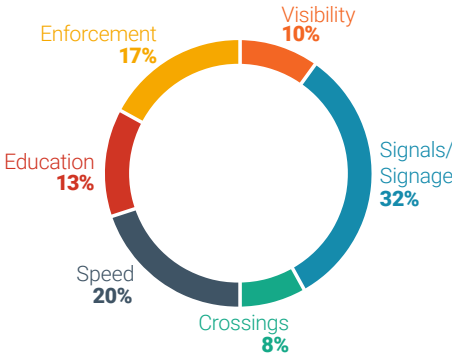

Engagement Events







October 27, 2018
Mutual Assistance Harvest Festival, Robertson Community Center

December 5, 2018
Hagginwood Community Association Meeting

June 6, 2019
Greater Sacramento Urban League Open House Event

Investments to Enhance Safety

Key Crash Countermeasures

Countermeasure	Crash Type	Feedback Key Theme
 <p>Slow Green Wave</p> <p>TO ADDRESS</p>	 <p>Unsafe Speed</p>	Speed
 <p>Add New Signal</p> <p>TO ADDRESS</p>	 <p>Pedestrian Crossing</p>	Visibility
 <p>Shorten Signal Cycle Length</p> <p>TO ADDRESS</p>	 <p>Signal or Sign Violation</p>	Signals/Signage

How Will The Roadway Space Be Used?

Section A Existing

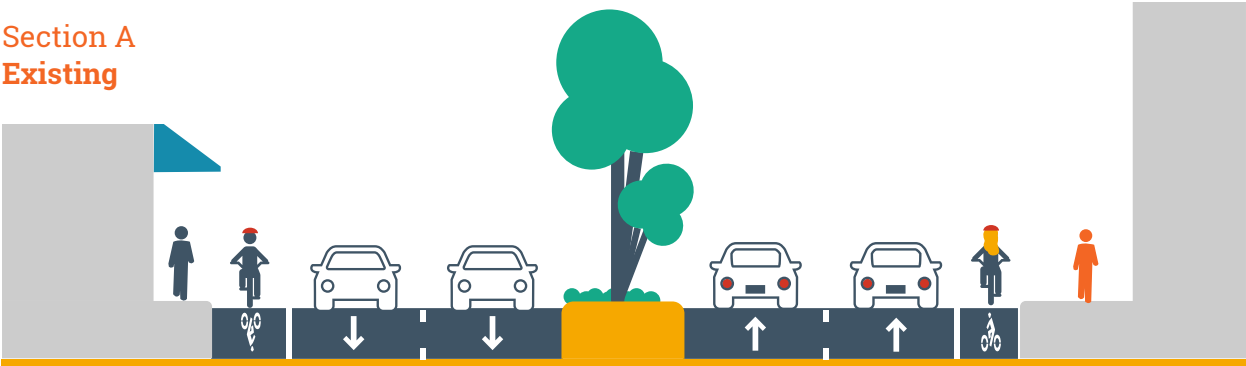

SEE PAGE B-13

Section A Proposed

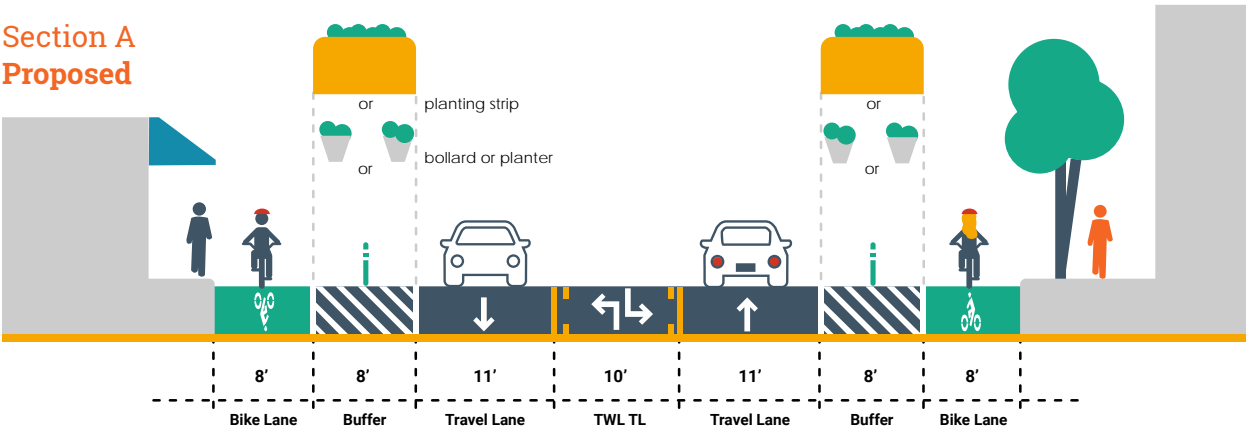

Conceptual Design for Marysville

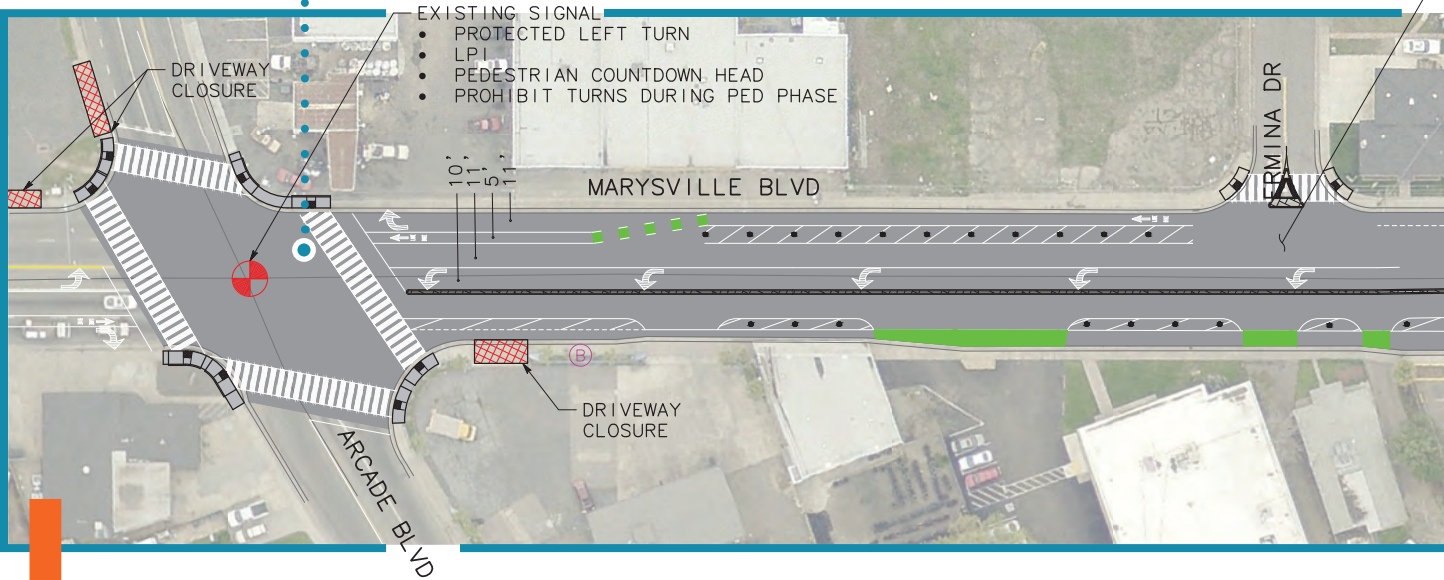

Marysville Boulevard/Arcade Boulevard Queues

During peak hours, drivers use Marysville Boulevard and Arcade Boulevard between I-80 and the Arden-Arcade neighborhood. Therefore, there is a large southbound left-turn volume (595-vehicles) during the AM peak hour, and a large westbound right-turn volume (575-vehicles) during the PM peak hour. The southbound left-turn queue currently spills out of the available storage length of the turn pocket during peak hours, and this condition could be exacerbated by the recommended road diet. However, the recommendations also include the extension of the southbound left-turn lane to 750-feet, which would include restricting the Marysville Boulevard Boulevard/Ermina Drive intersection to right-in/right-out access only. The resulting maximum peak hour queues are shown in Appendix B.



Extend Signal Clearance Time



Slow Green Wave

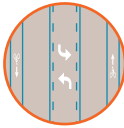

Road Diet

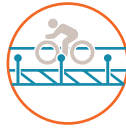

Separated Bikeway

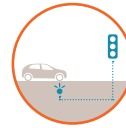

Advanced Dilemma-Zone Detection

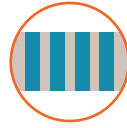

High Visibility Crosswalk

Corridor-Wide Recommendations

Location-Specific Recommendations

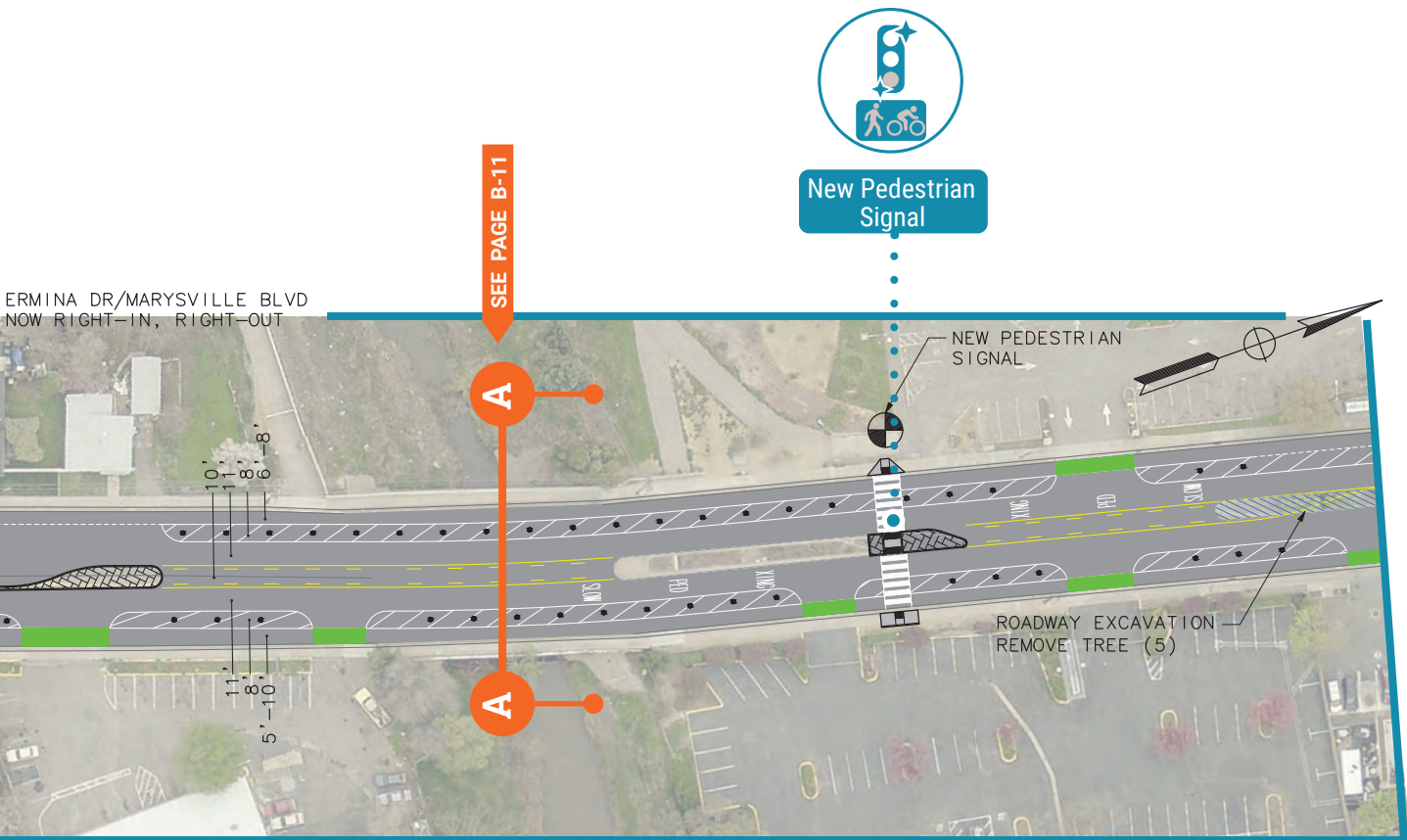

Conceptual Design for Marysville

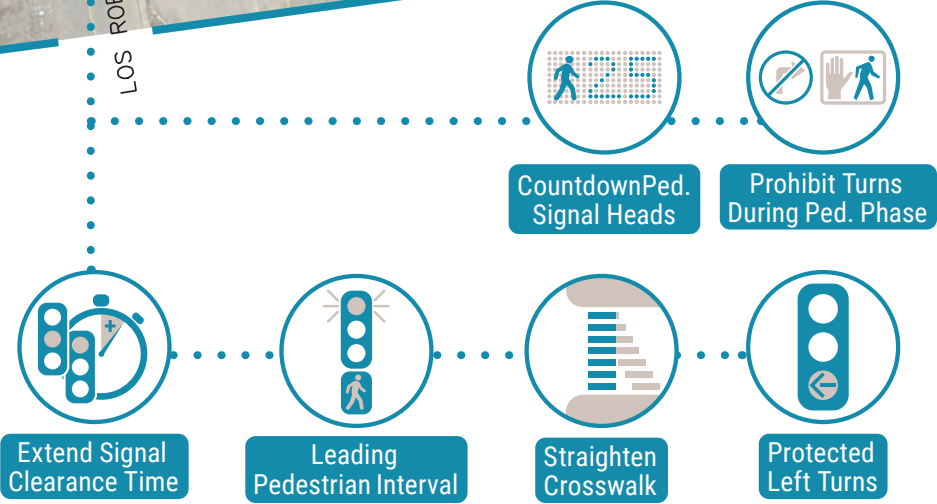
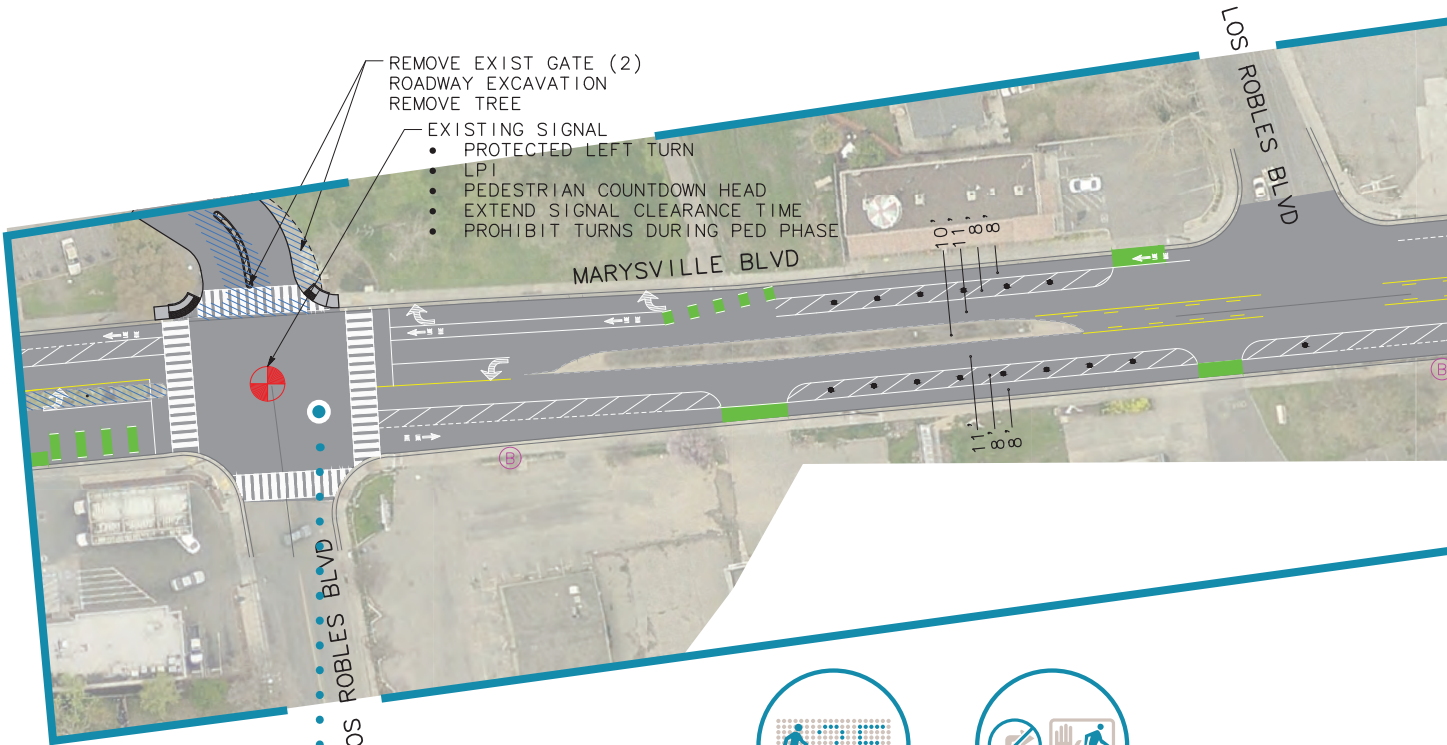



Extend Signal Clearance Time



Slow Green Wave

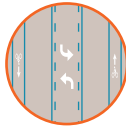

Road Diet

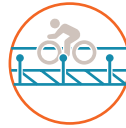

Separated Bikeway

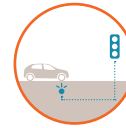

Advanced Dilemma-Zone Detection



High Visibility Crosswalk

Corridor-Wide Recommendations

Location-Specific Recommendations

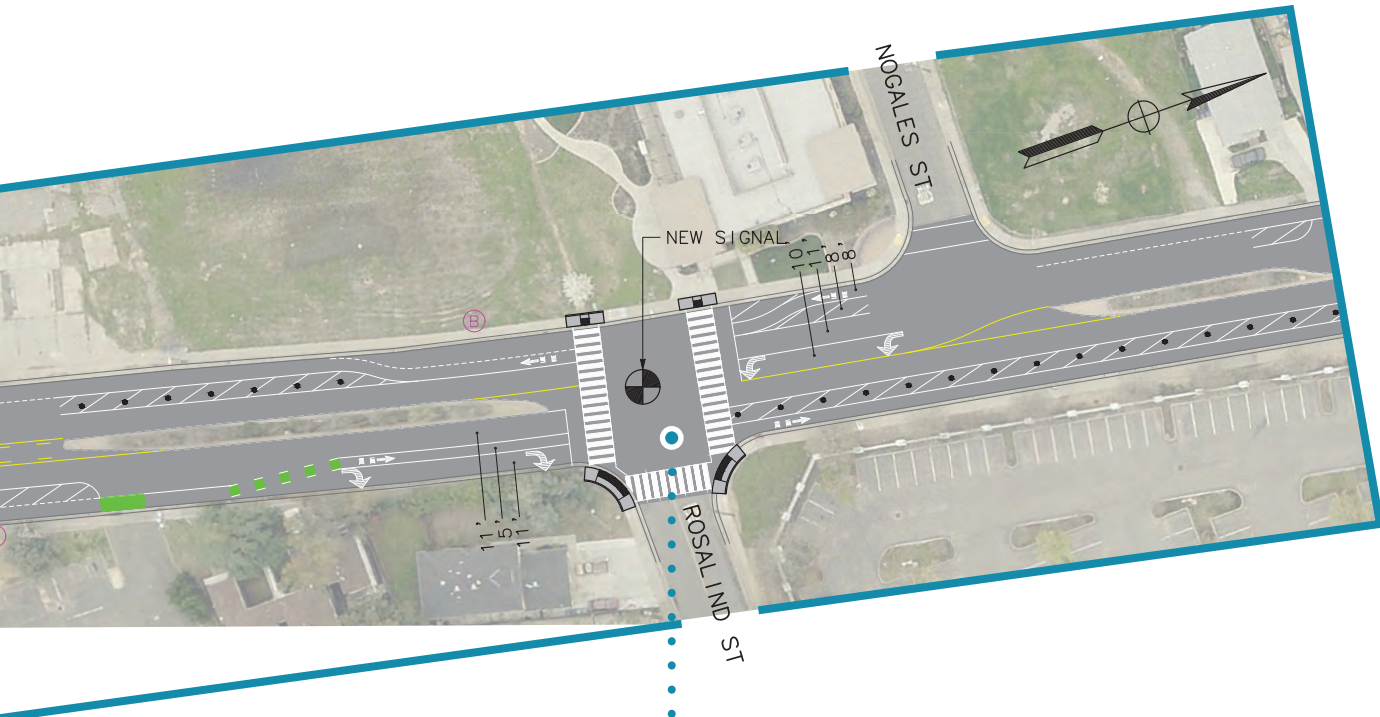

New Traffic Signal



Co-Locate Bus Stops and Ped Crossings

Conceptual Design for Marysville

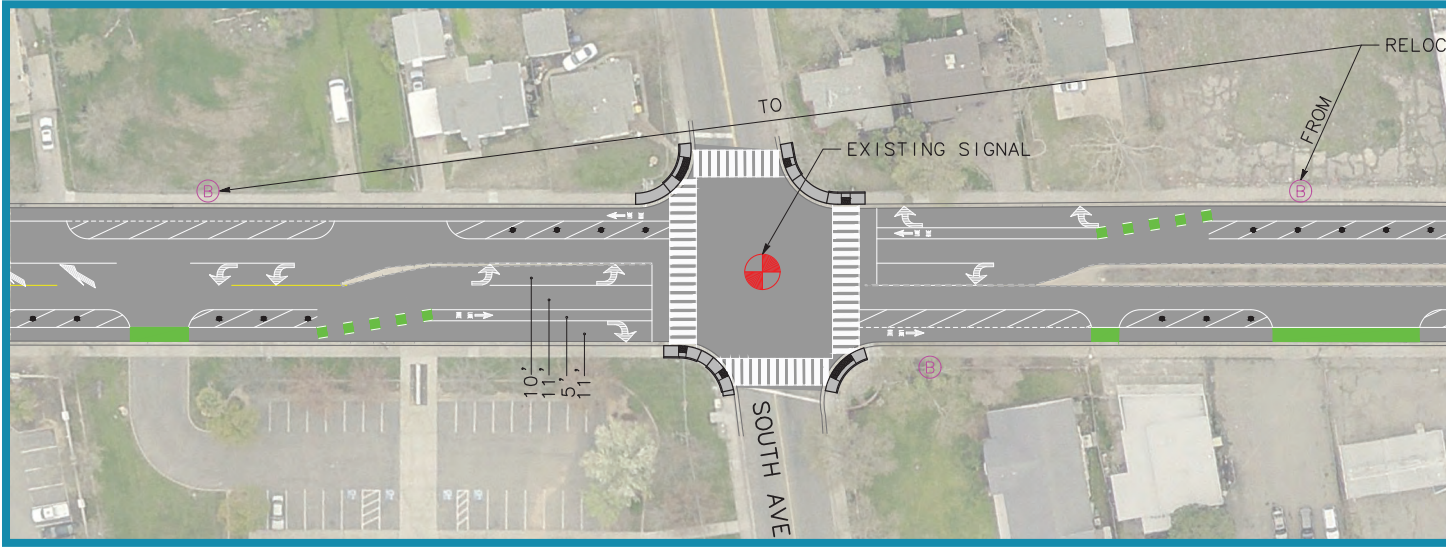

Conceptual Design for Marysville

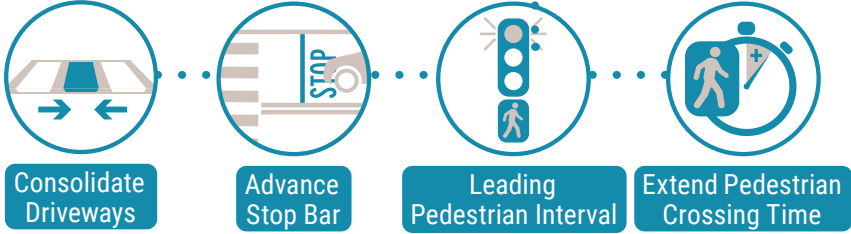
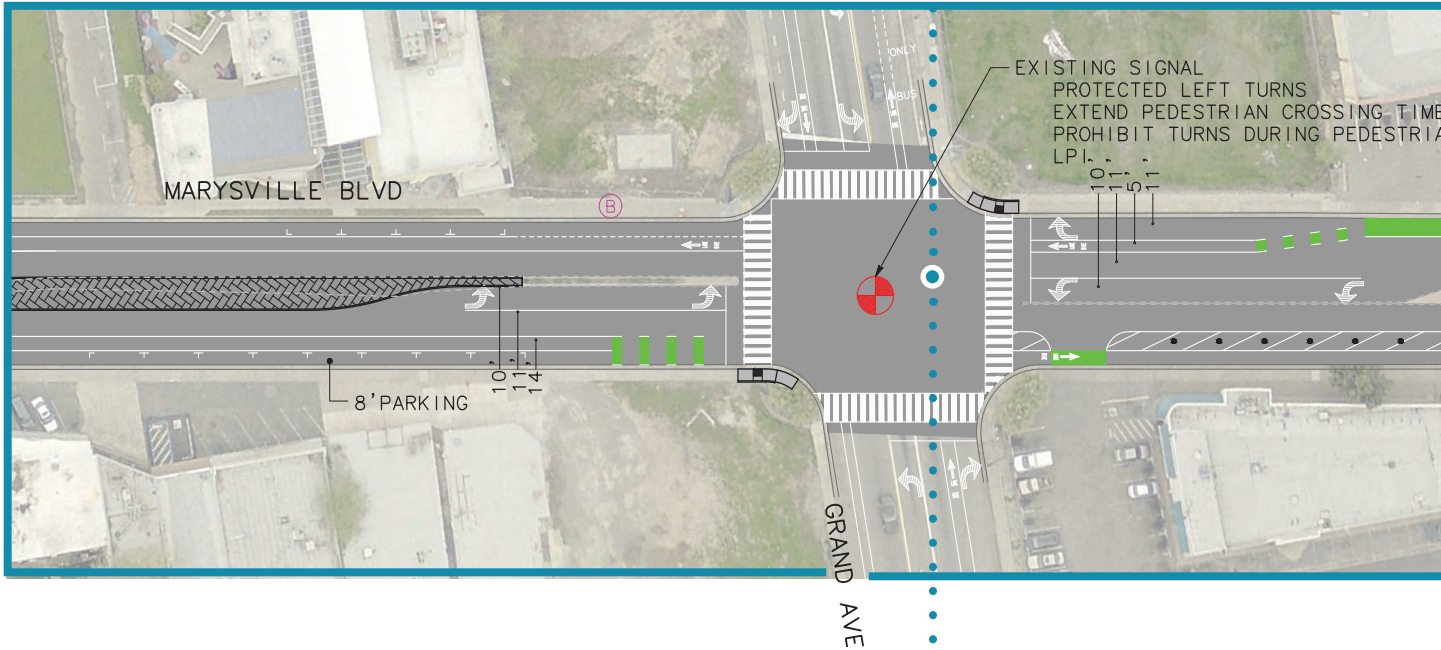
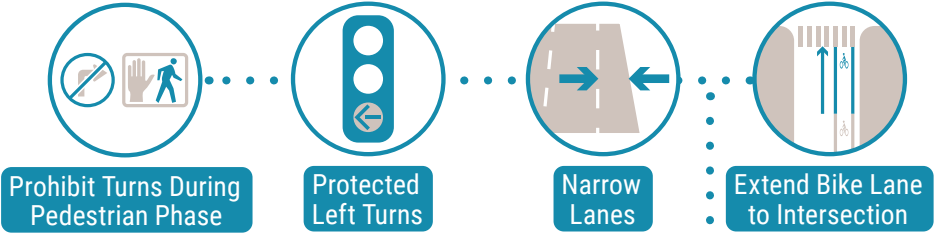



Extend Signal Clearance Time



Slow Green Wave

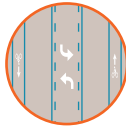

Road Diet

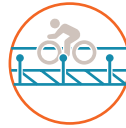

Separated Bikeway

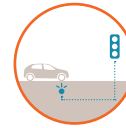

Advanced Dilemma-Zone Detection



High Visibility Crosswalk

Corridor-Wide Recommendations

Location-Specific Recommendations

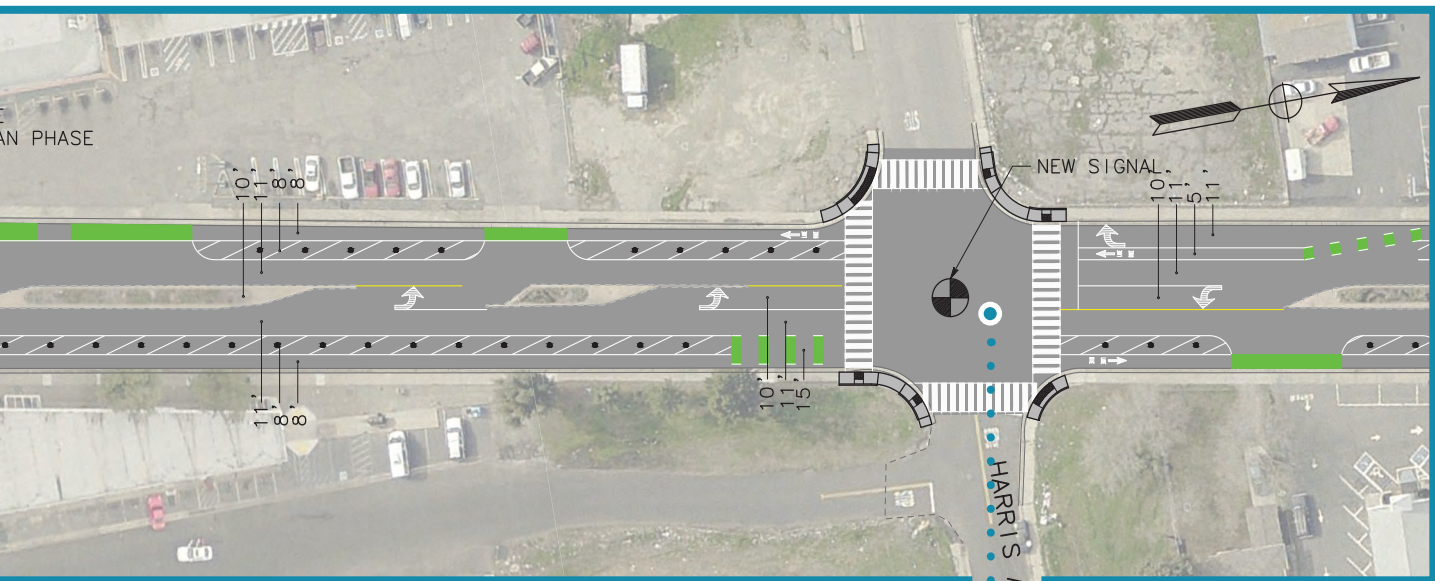

HARRIS AVE

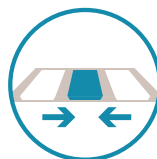

Consolidate Driveways



New Traffic Signal

Conceptual Design for Marysville

Marysville Boulevard/North Avenue Queues

The Marysville Boulevard/North Avenue intersection is 475 feet away from the merge point of the I-80 eastbound off-ramp to the north. Measures should be taken to ensure that the southbound queue at the intersection does not spill back to the off-ramp. The conceptual plans show the southbound approach is comprised of two-through lanes with a lane drop as the road continues south. The peak hour maximum queues result from this configuration are in Appendix B.

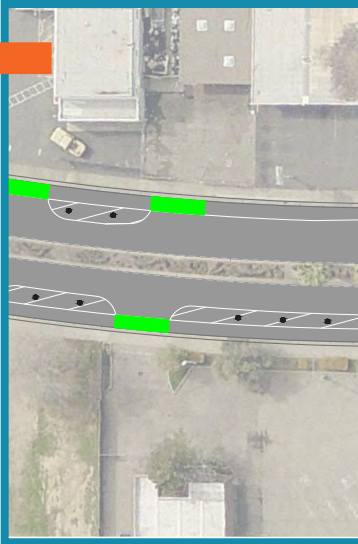



Extend Signal Clearance Time



Slow Green Wave

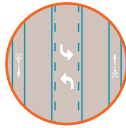

Road Diet

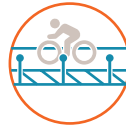

Separated Bikeway

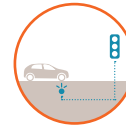

Advanced Dilemma-Zone Detection



High Visibility Crosswalk

Corridor-Wide Recommendations

Location-Specific Recommendations

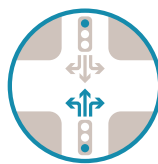
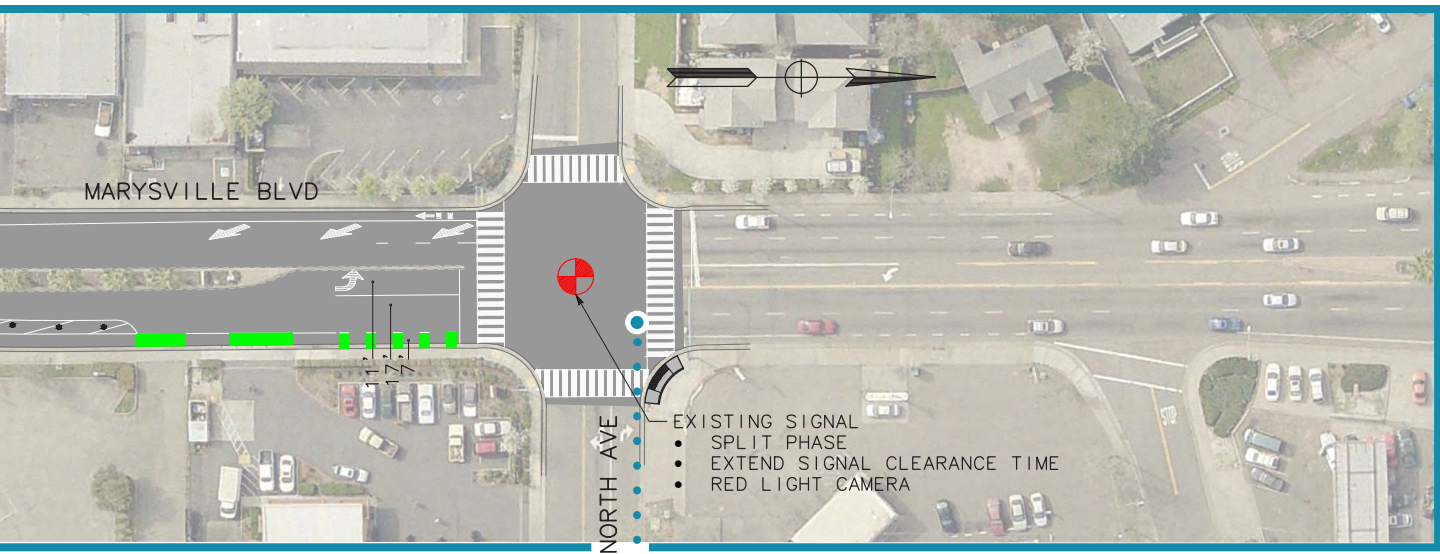

Split Signal Phase

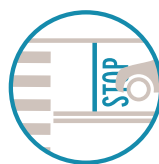

Advance Stop Bar



Extend Signal Clearance Time



Red Light Camera



Parking Prohibition

How Will Travel Change?

Estimated Changes with Project

Average Vehicle Speed

Average vehicle speed along the corridor during peak periods is expected to decrease between 3 and 6 mph as a result of the proposed project. While slower travel speeds result in longer travel times, they reduce traffic fatalities and severe injuries that result from crashes.

Northbound



Southbound

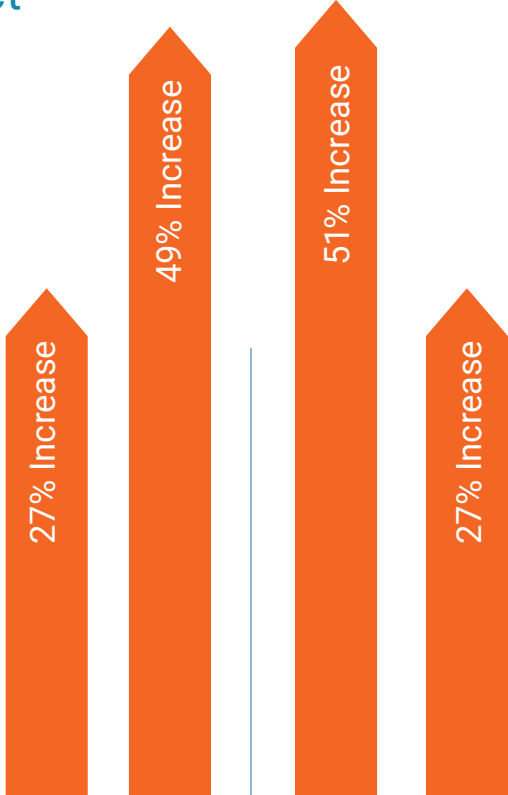

Northbound



Southbound



Vehicle Travel Time

Average vehicle travel time along the one-mile corridor during peak periods is expected to increase between 52 and 110 seconds as a result of the proposed project.

Estimated Changes with Project

Bike Lane Coverage

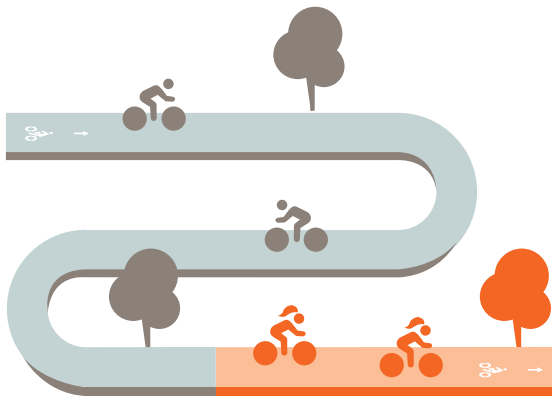

Without project
82%
(9,740 ft)

▶

With project
100%
(11,830 ft)

Share of Bike Lanes with Vertical Separation

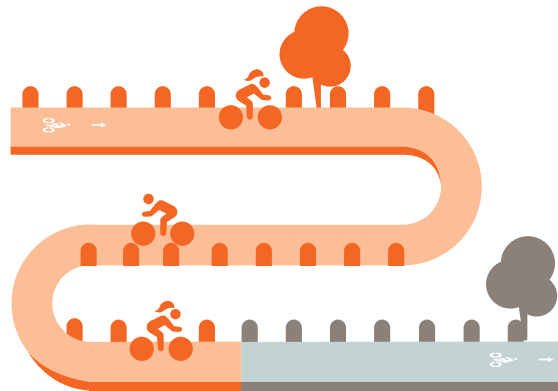

Without project
0%
(0 ft)

▶

With project
78%
(9,280 ft)

Distance Between Crosswalks

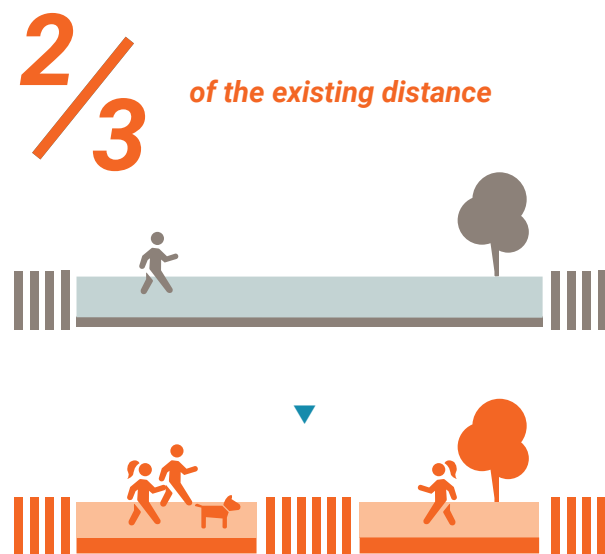

*Longest distance between crosswalks reduced from 1,230 to 800 ft.

Distance Between Crosswalks and Bus Stops

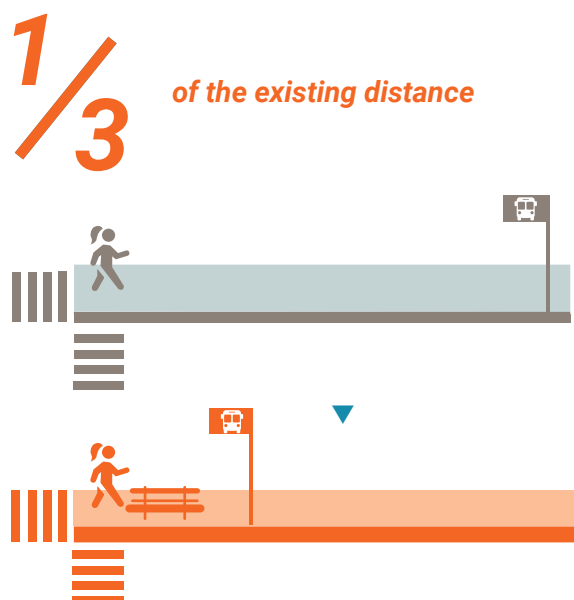

*Longest distance between a bus stop and the closest crosswalk reduced from 630 to 230 ft.

How Much Will the Project Cost?

Marysville Boulevard Cost Summary

\$12,850,000

Construction

Construction costs include the cost to build the primary items associated with the safety countermeasures for the corridor. The items were estimated based on the preliminary design concepts and recent construction bid unit costs with an escalation factor to account for future construction. The costs were broken down into two categories that consisted of major roadway items and electrical items such as traffic signals and lighting. A contingency factor was included to account for refinement of project design, changes in project details, or unforeseen changes in construction costs.

Actual project costs will be determined by surveyed base mapping, geotechnical reports, concept refinement, environmental reviews, right of way availability, project phasing, and bid conditions at the time of advertisement. Project costs should be reviewed prior to any grant application or initiation of a Capital Improvement Project to revalidate and update the assumptions in this study as necessary.

Right of Way

In addition to construction costs, right of way costs were assumed that include temporary construction easements for items such driveway modifications, curb ramps reconstruction, signal equipment poles and cabinets. The preliminary design assumes that the project can be constructed almost exclusively within the roadway prism and right of way acquisition along entire project frontage is not needed. Further refinement of the base mapping in subsequent phases of design will more accurately identify specific right of way needs.

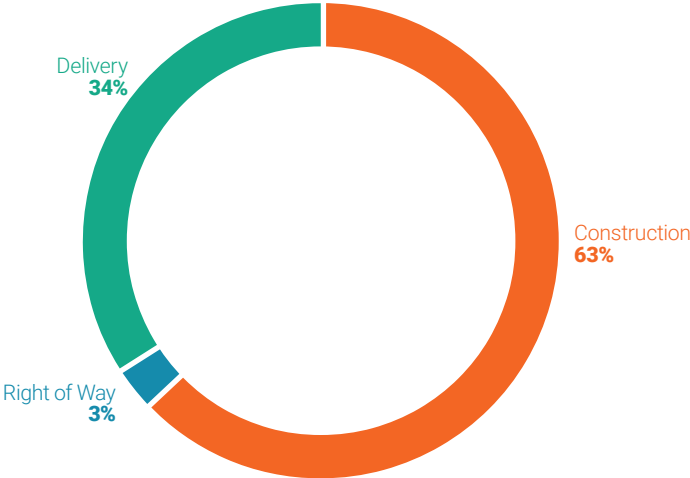

The total project costs shown in the summary chart have been escalated at an assumed 3% per year escalation factor to 2025, the anticipated year of construction.

Delivery

Project delivery costs are included in the estimates provided in this study. These costs encompass all of the work to complete subsequent phases including preliminary engineering, environmental documentation, final design, right of way engineering, and construction oversight. A breakdown of these costs is provided in Appendix C.



Stockton BLVD
2900

Broadway/Stockton

Vision Zero
Top 5 Corridor

Stockton Boulevard at Broadway

Broadway/Stockton Boulevard

Vision Zero Top 5 Corridor

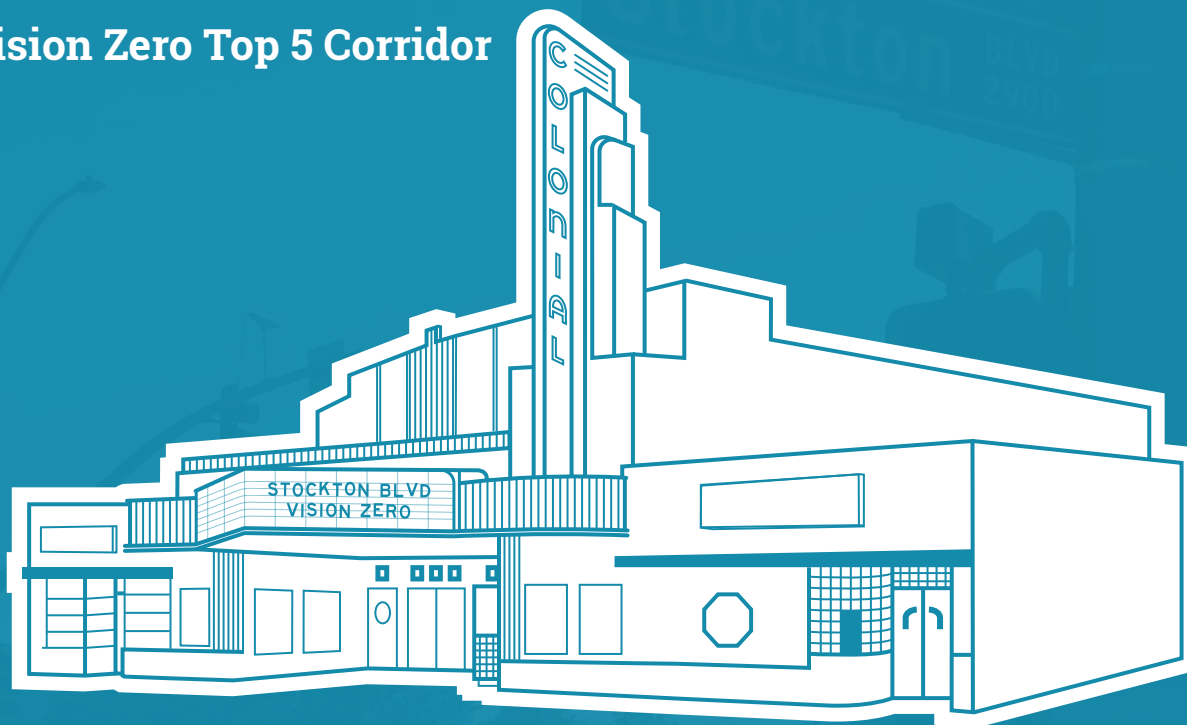

Broadway/Stockton Blvd - Colonial Theater

What is going on?

Between 2009 and 2017, 15 crashes that resulted in a fatality or severe injury (KSI) occurred on Broadway/Stockton Boulevard between Martin Luther King Jr. Boulevard and 14th Avenue. Six of these crashes involved a pedestrian and three of these crashes involved a bicyclist. Of the 122 crashes studied on this corridor, 34 crashes (27 percent) occurred at the Broadway/Stockton Boulevard intersection.

What are the key issues?

Unsafe speed was the most common violation for vehicular crashes, and many drivers were proceeding straight or stopped at the time of the crash. On Broadway, half of the pedestrian crashes involved a pedestrian crossing the street outside of a crosswalk, whereas on Stockton Boulevard, 60 percent of pedestrians hit by drivers were crossing the street in a marked crosswalk. Bike crashes on this corridor involved broadside, or T-Bone, and sideswipe crashes.

What is the community concerned about?

Residents described frequent jaywalking activity throughout the corridor and suggested that it is result of lack of crosswalks, specifically near bus stops. Residents said it is uncomfortable to bike since there are gaps in the bike lanes and drivers tend to speed while traveling. The segment of Stockton Boulevard overlaps with the Stockton Boulevard Corridor Study.

The following pages lay out the existing conditions along the corridor, feedback heard from residents at outreach events, and a set of roadway safety recommendations focused on slowing drivers down, providing separated space for bicyclists, and giving pedestrians more opportunities for safe crossings.

Table of Contents

C-4

**In the
Neighborhood**

C-6

**Travel on
Broadway**

C-8

Travel on Stockton

C-10

**Safety on
Broadway**

C-12

Safety on Stockton

C-14

**Feedback from the
Community**

C-15

**Investments to
Enhance Safety**

C-18

**Conceptual Design
for Broadway**

C-24

**Conceptual Design
for Stockton**

C-30

**How Will Travel
Change on Broadway**

C-32

**How Will Travel
Change on Stockton**

C-34

**How Much Will the
Project Cost?**

In the Neighborhood

Corridors

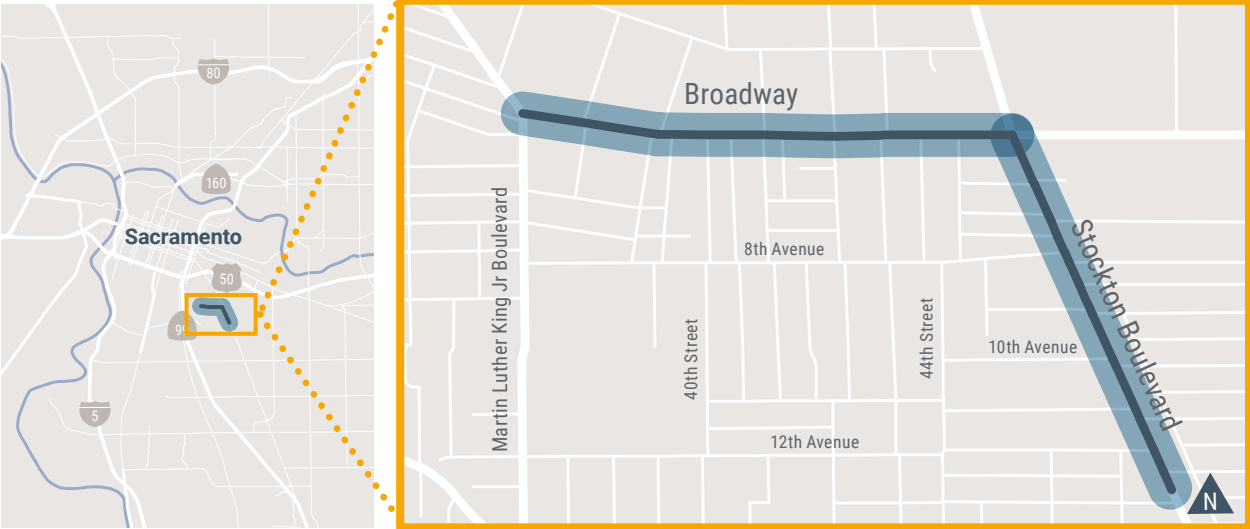

About the Neighborhood

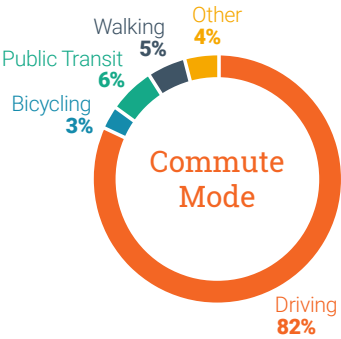

Residents take transit, walk, or bike to work at a higher rate than the city as a whole.

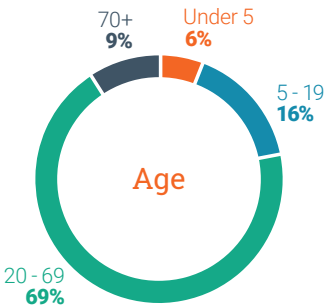

A larger share of residents in this neighborhood are age 20-69, compared with the city as a whole.

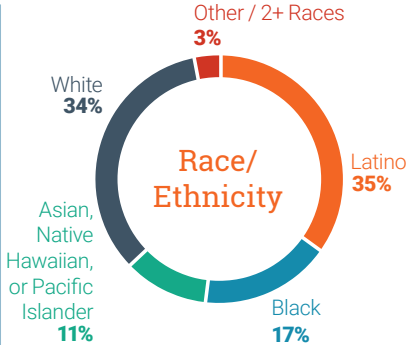

52% of the residents in this neighborhood are Black or Latino, compared with 42% citywide.



Key Destinations Along the Corridors

Parks



Schools & Libraries



Food Markets

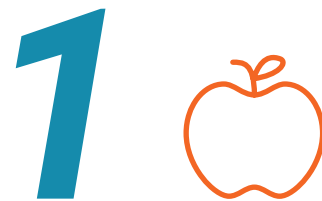

Houses of Worship



Theaters



Travel on Broadway

Key Statistics

Posted Speed Limit

30
MPH

Daily Vehicles

15,800

Maximum PM Intersection Vehicle Volume

1,744

PM Rush Hour People Walking

126

PM Rush Hour People Biking

92

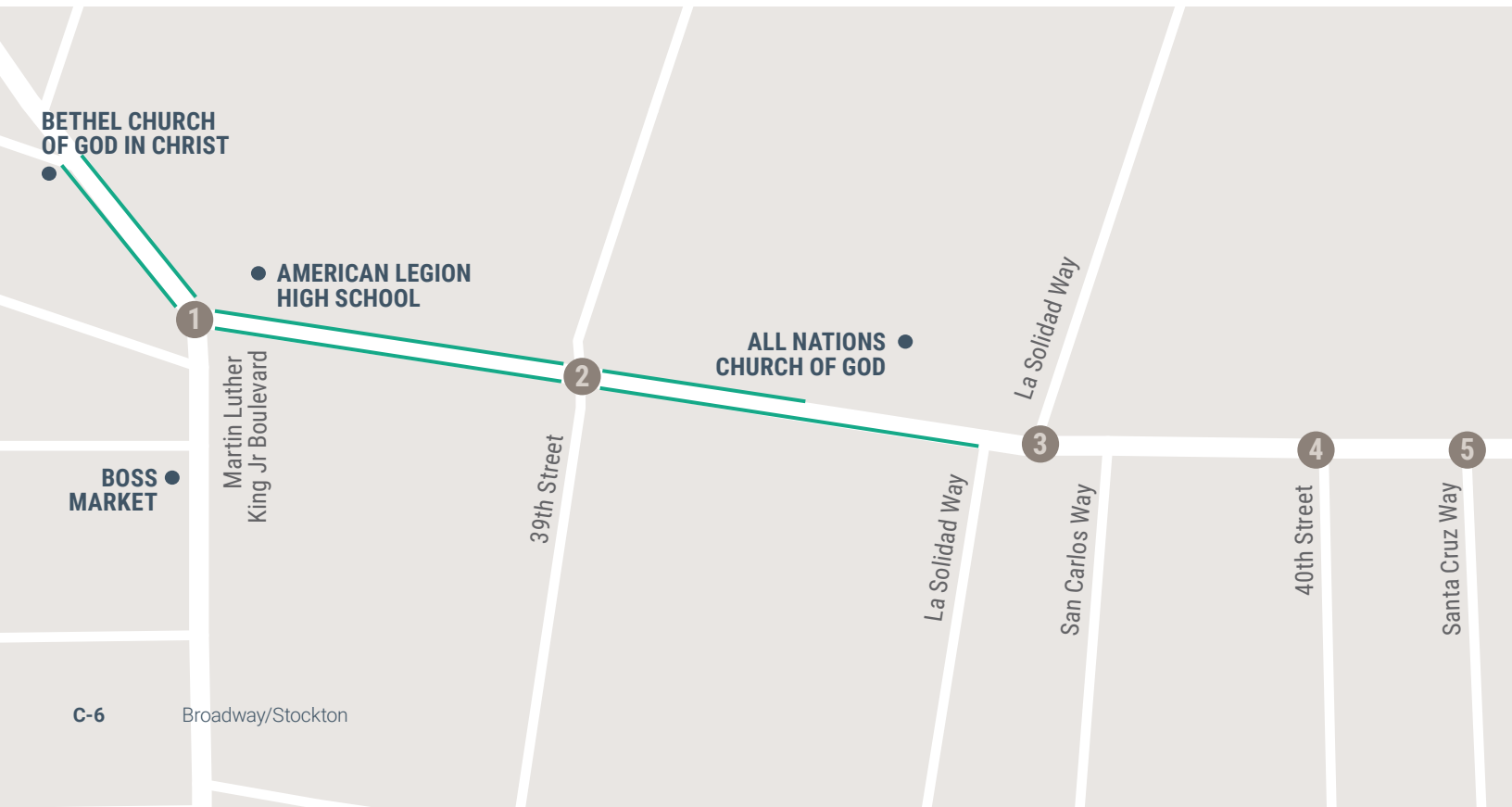
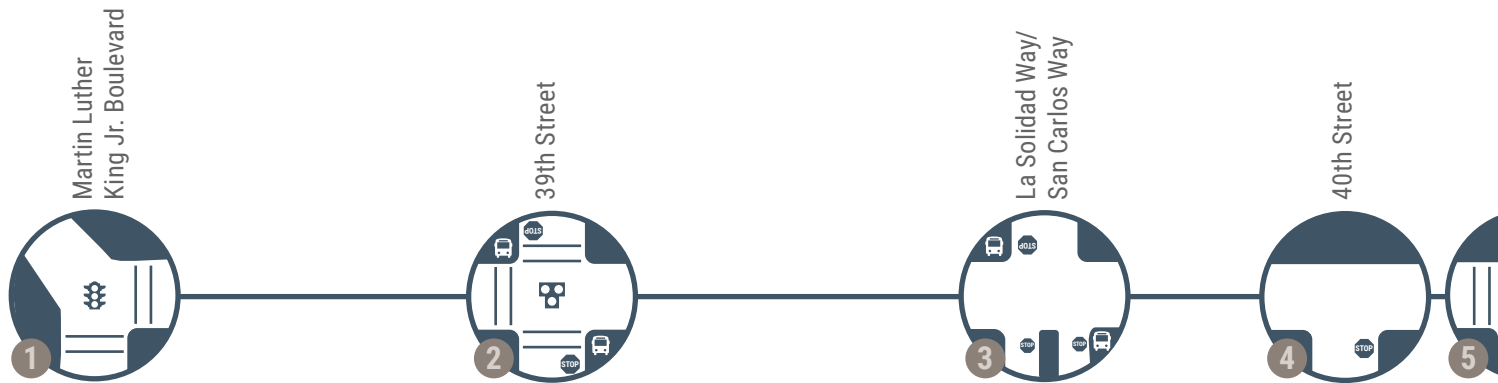

Number of Transit Routes

3

#51, #206, #214

Bikeway Type

On-Street Bike Lanes, with long gaps

Longest Distance Between Marked Crosswalks

930 Ft

Sidewalk Coverage

100%

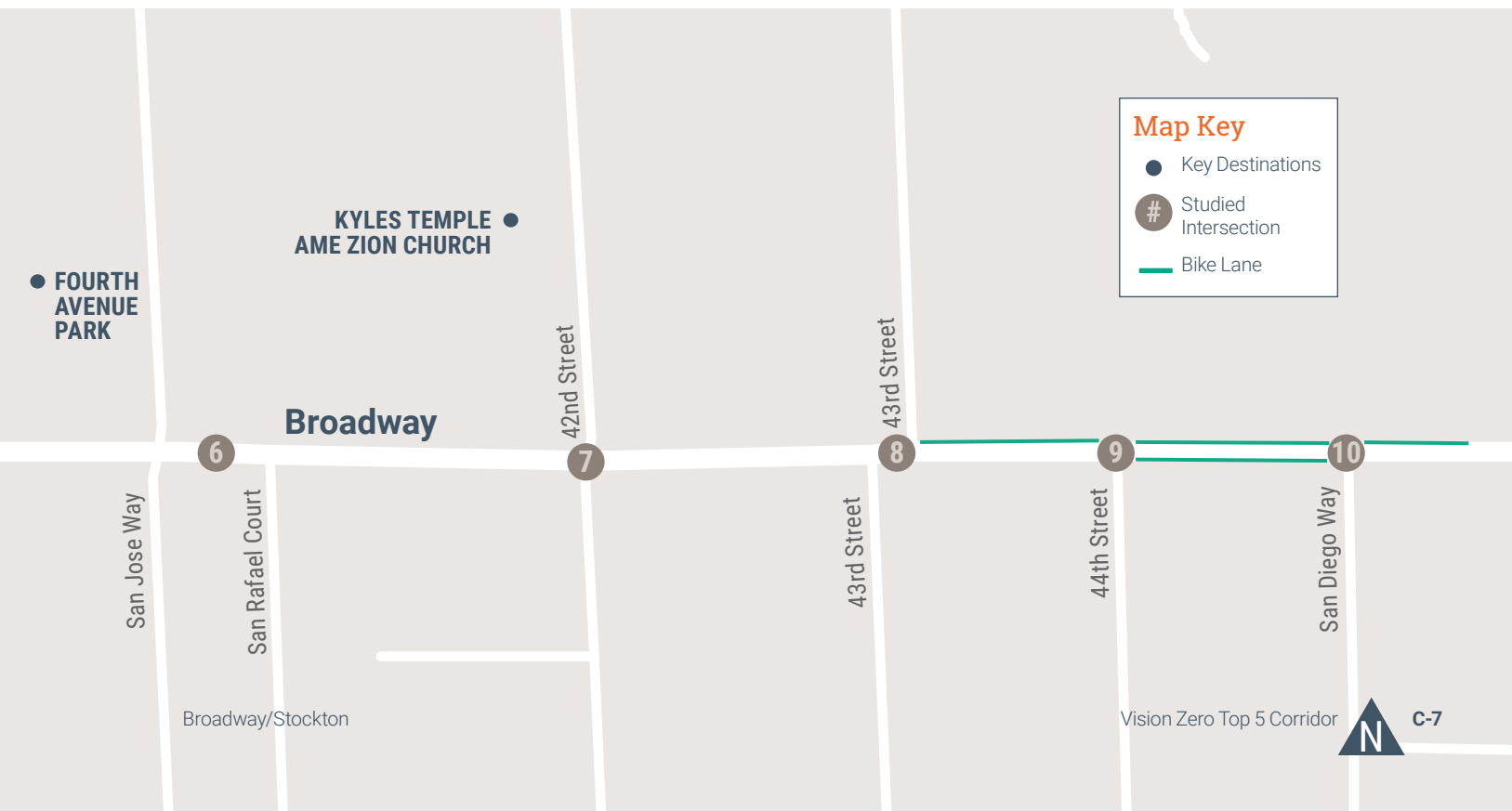
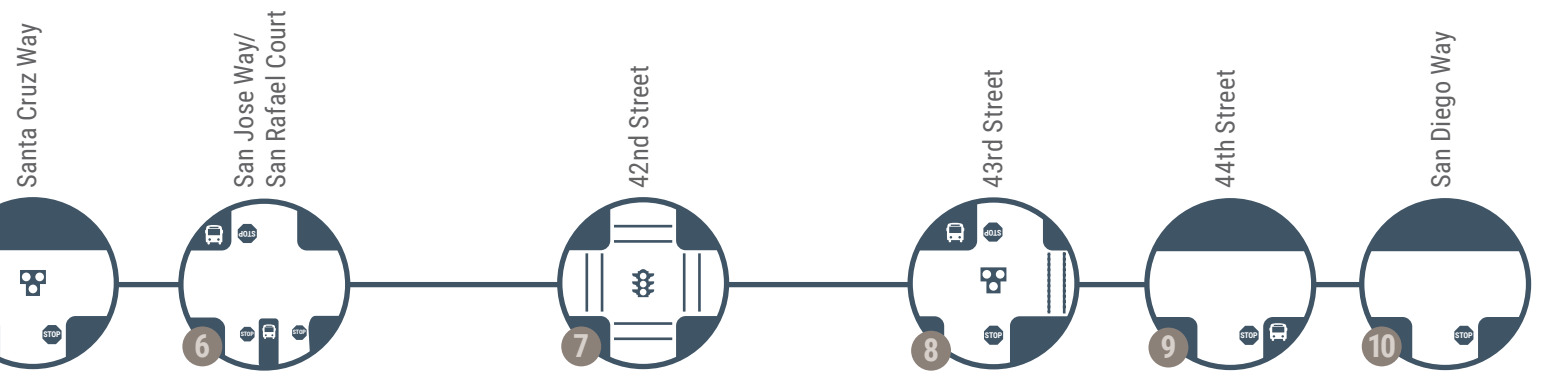

Travel on Stockton

Key Statistics

Posted Speed Limit

35
MPH

Daily Vehicles

19,600

Maximum PM Intersection Vehicle Volume

1,843

PM Rush Hour People Walking

151

PM Rush Hour People Biking

134

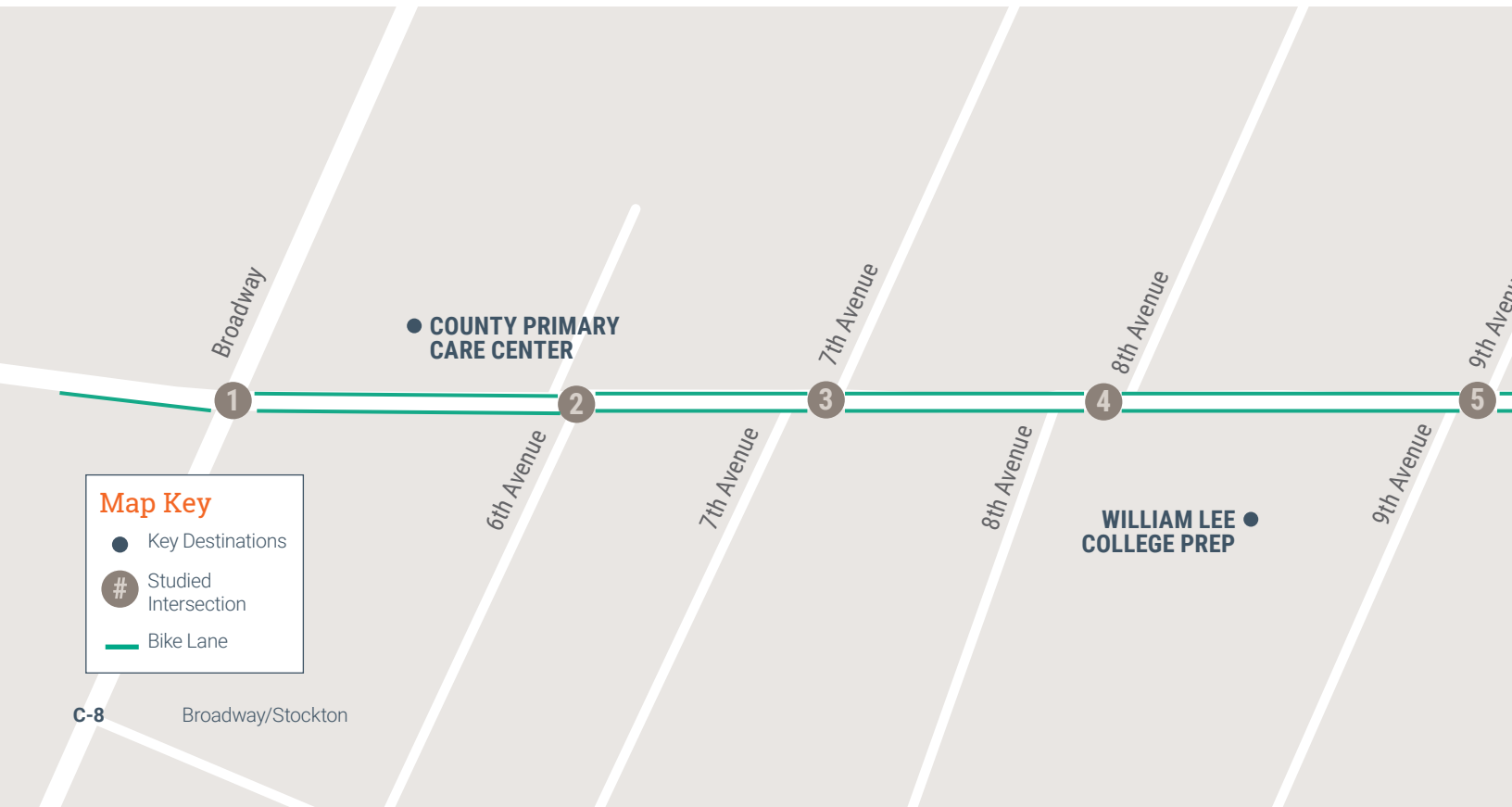
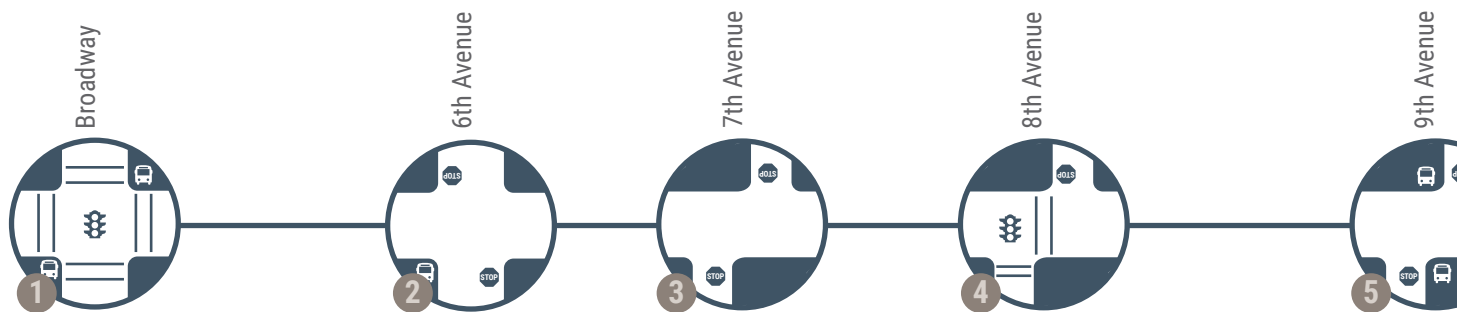

Map Key

- Key Destinations
- # Studied Intersection
- Bike Lane

Number of
Transit Routes

2
#51, #213

Bikeway
Type

**On-Street
Bike Lanes**

Longest Distance
Between Marked
Crosswalks

1,560
Ft

Sidewalk
Coverage

100%

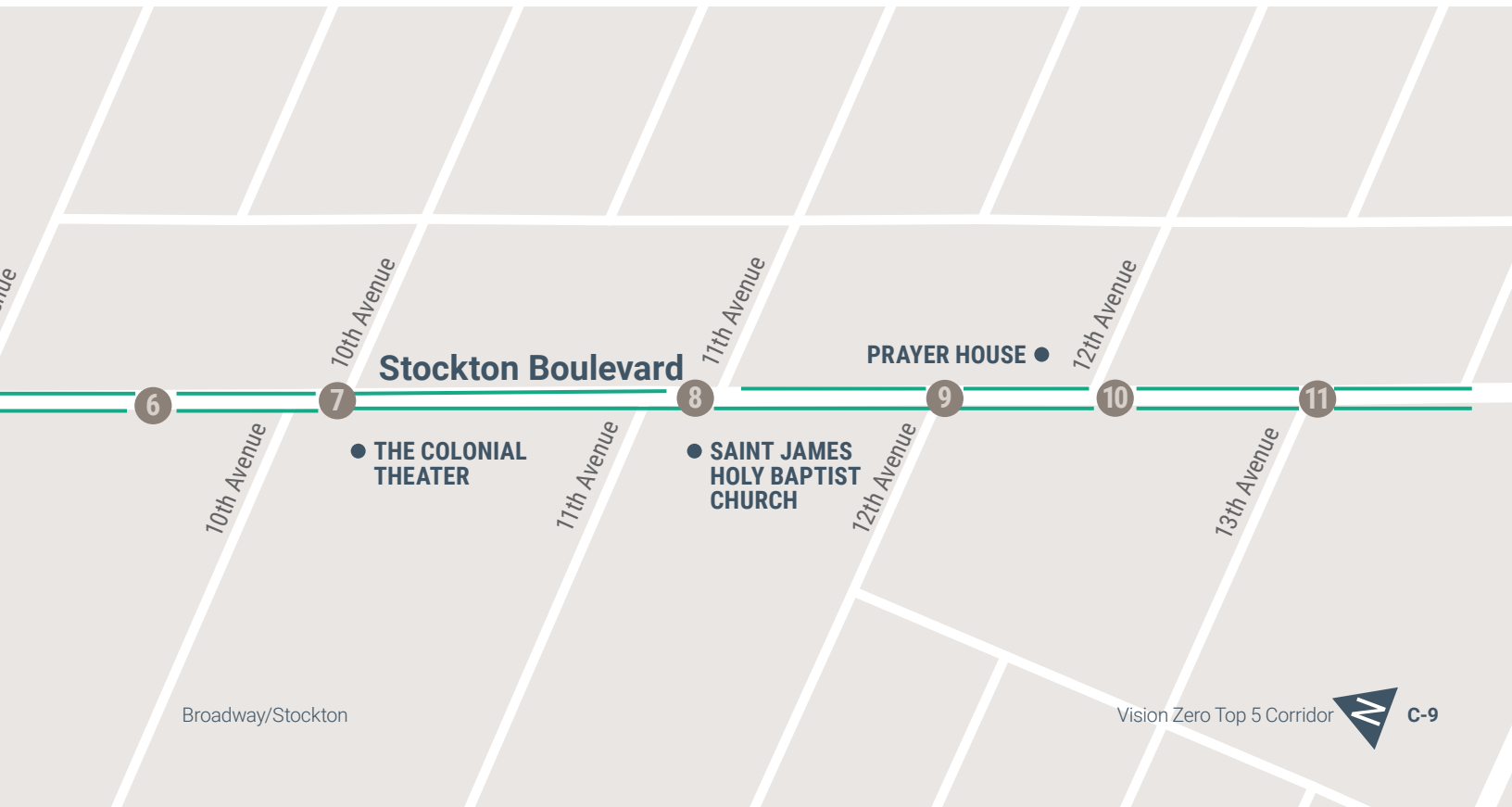
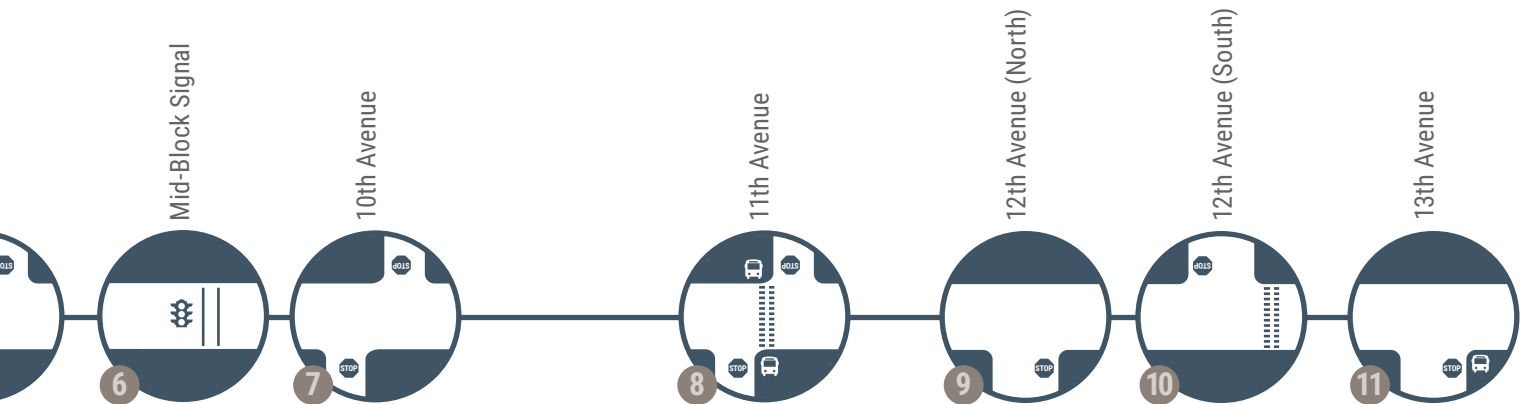

Crashes on Broadway

Vehicle Crash Types

Unsafe Speed

"Unsafe Speed" was the most common violation, cited in 28% of all crashes.

1 2 3 4 5 6
7 8 9 10

Proceeding Straight

More than 2/3 of drivers were proceeding straight or stopped at the time of the crash.

1 2 3 4 5 6
7 8 9 10

Left Turns

Nearly 2/3 of drivers who were turning at the time of the crash were making a left turn.

1 2 3 4 5 6
7 8 9 10

Crash Locations

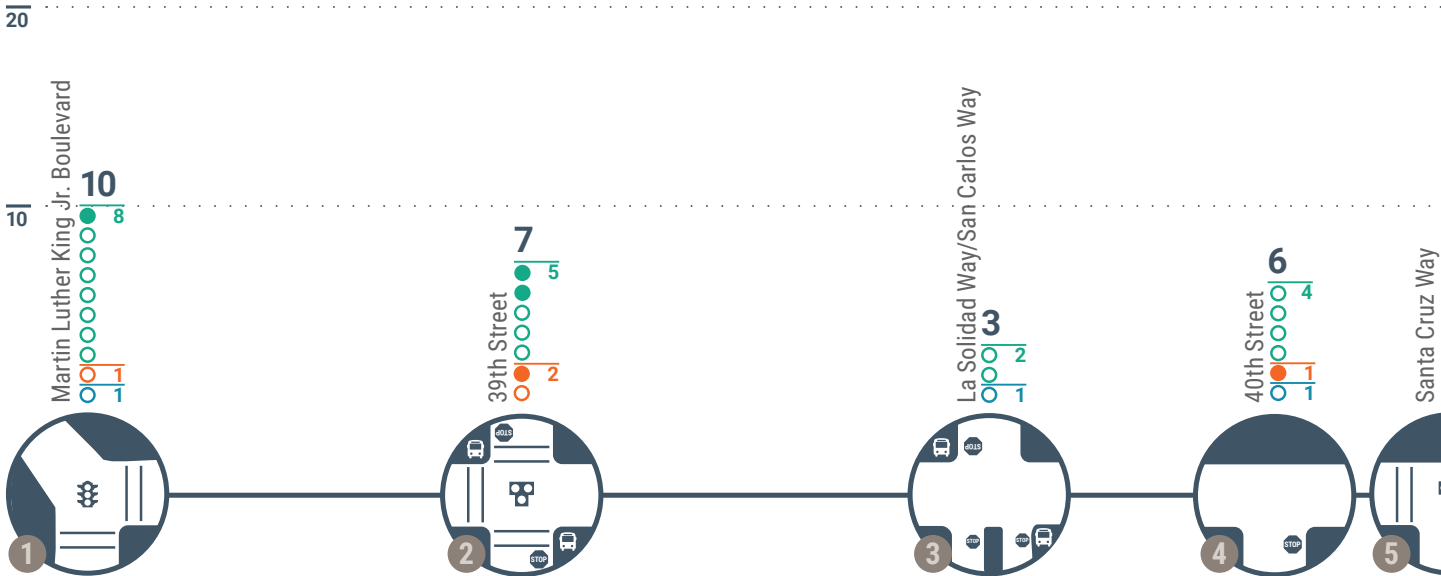

Pedestrian Crash Types



Not in Crosswalk

Half of pedestrians hit were crossing outside of a crosswalk at the time of the crash.



Weekend

Nearly 2/3 of pedestrian crashes occurred on Friday or Saturday.



Bike Crash Types



Sideswipe

45% of bike crashes were sideswipe.



1 Numbers that are turned on represent a location where crash type has occurred at least three times.

Total Crashes			
	All Injury Crashes	Fatal and Severe Crashes	
Vehicle	38	4	
Pedestrian	8	3	
Bike	11	1	

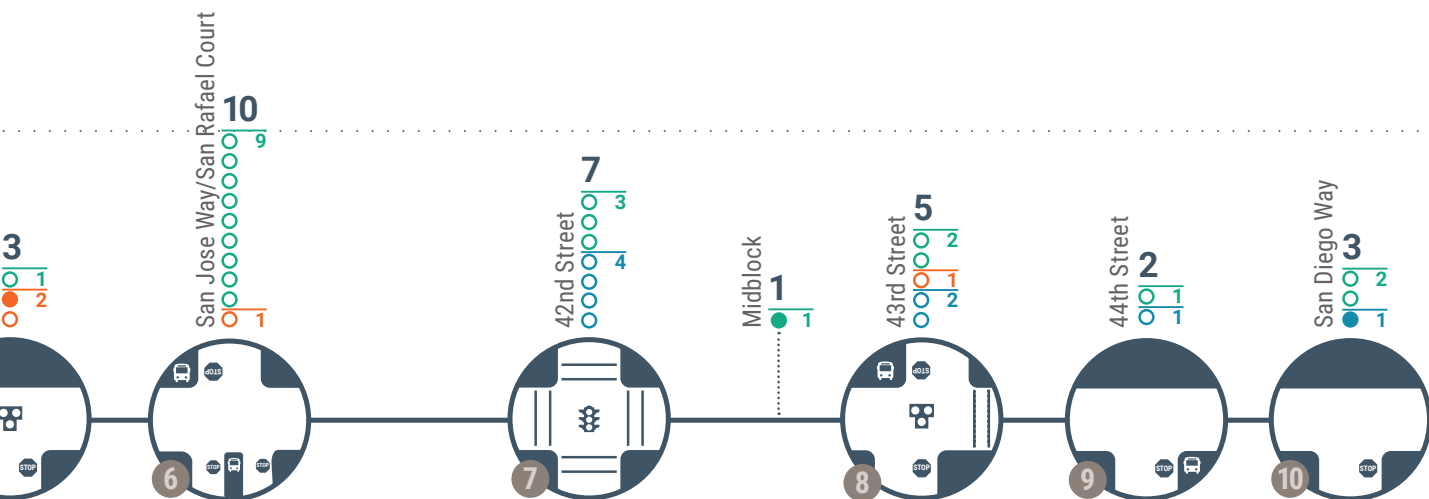

Crashes on Stockton

Vehicle Crash Types

Unsafe Speed

"Unsafe Speed" was the primary violation cited in 23% of all crashes.

1 2 3 4 5 6
7 8 9 10 11

Proceeding Straight

More than 60% of drivers were proceeding straight or stopped at the time of the crash.

1 2 3 4 5 6
7 8 9 10 11

Broadside

40% of all crashes were broadside, also called T-Bone.

1 2 3 4 5 6
7 8 9 10 11

Crash Locations

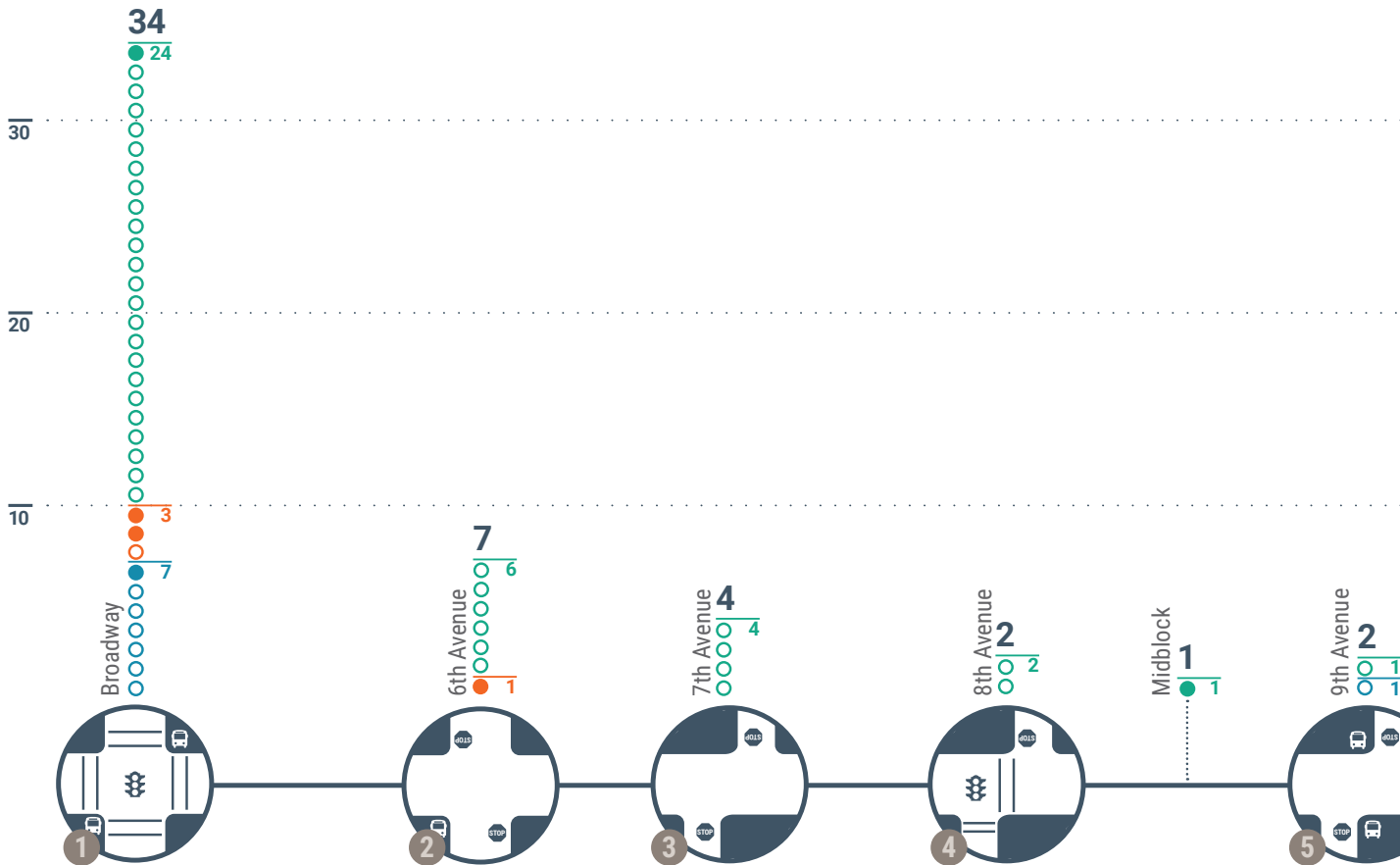

Ped Crash Types

Bike Crash Types

Crossing in Crosswalk

60% of pedestrians hit by drivers were crossing in a crosswalk at the time of the crash.

1 2 3 4 5 6
7 8 9 10 11

Broadside

More than 60% of bike crashes were broadside, also called T-Bone.

1 2 3 4 5 6
7 8 9 10 11

Morning

More than 60% of bike crashes occurred before noon.

1 2 3 4 5 6
7 8 9 10 11

1 Numbers that are turned on represent a location where crash type has occurred at least three times.

Total Crashes			
	All Injury Crashes	Fatal and Severe Crashes	
Vehicle	47	2	
Pedestrian	5	3	
Bike	13	2	

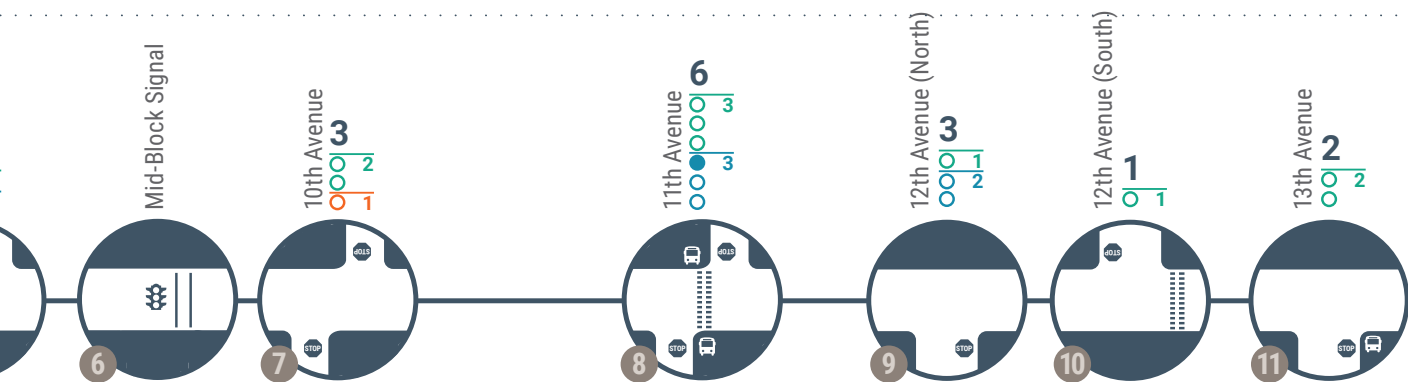

Feedback from the Community

“ People drive too fast and run the right turn red lights at the Broadway/Stockton intersection.”

“ More crosswalks! Cars do not stop, and there are bus stops not too far from crosswalks.”



Key Themes

Pedestrian Safety

Residents said that this corridor has a lot of pedestrian activity but believed that drivers should travel more cautiously, specifically when making right-turns on the corridor or driving near crosswalks.

Signals/Signage

Residents described red light running at traffic signals and suggested that more traffic signals could slow down traffic.

Crossings

Residents described jaywalking throughout the corridor and suggested that it is result of lack of crosswalks specifically near bus stops.

Speed

Residents described drivers speeding and traveling aggressively through the corridor and said they were uncomfortable walking and biking as a result.

Bike Safety

Residents said it is uncomfortable to bike along the corridor since the bike lanes are inconsistent.

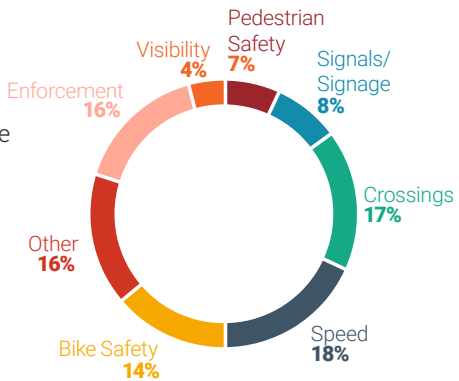





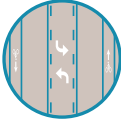

Engagement Events

- October 25, 2018
 Fall Family Festival, Oak Park Community Center
- November 7, 2018
 Transit Stop at Broadway/ Stockton Pop-up
- May 31, 2018
 Let's Move! Event, McClatchy Park

Investments to Enhance Safety

Key Crash Countermeasures for Broadway

Countermeasure	Crash Type	Feedback Key Theme
 <p>Road Diet</p> <p>TO ADDRESS</p>	 <p>Unsafe Speed</p>	Speed
 <p>Add New Signal</p> <p>TO ADDRESS</p>	 <p>Not in Crosswalk</p>	Crossings
 <p>Separated Bikeway</p> <p>TO ADDRESS</p>	 <p>Sideswipe (Bike)</p>	Bike Safety

How Will The Roadway Space Be Used?

Section B Existing

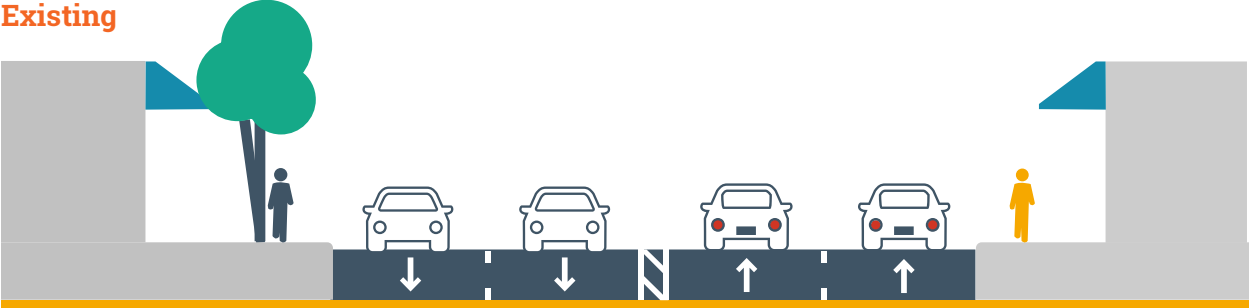





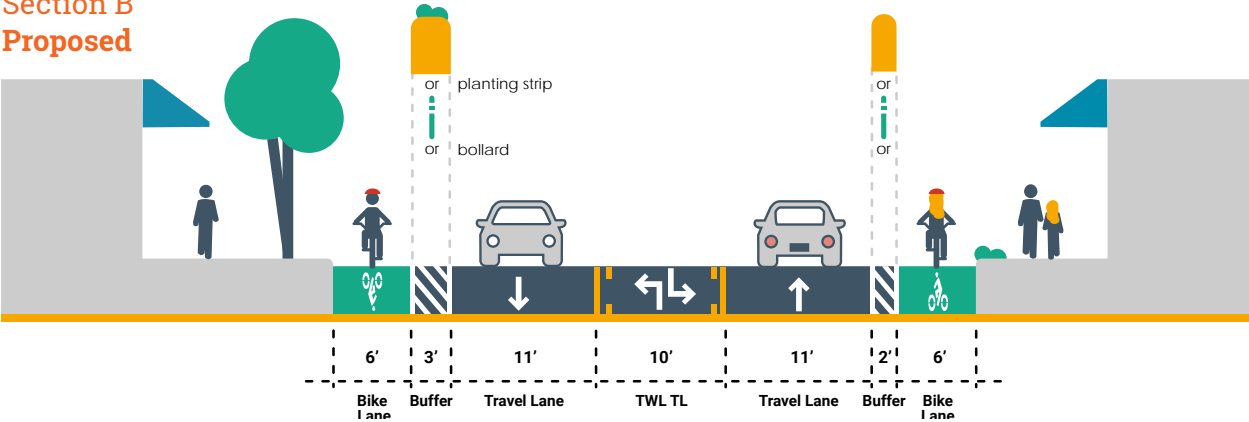

SEE PAGE C-20

Section B Proposed

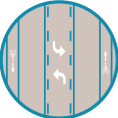

Investments to Enhance Safety

Key Crash Countermeasures for Stockton

Countermeasure	Crash Type	Feedback Key Theme
 <p>Road Diet</p> <p>TO ADDRESS</p>	 <p>Unsafe Speed</p>	Speed
 <p>Leading Pedestrian Interval</p> <p>TO ADDRESS</p>	 <p>Crossing in Crosswalk</p>	Crossings
 <p>Extend Signal Clearance Time</p> <p>TO ADDRESS</p>	 <p>Broadside</p>	Signals/Signage

How Will The Roadway Space Be Used?

Section C Existing

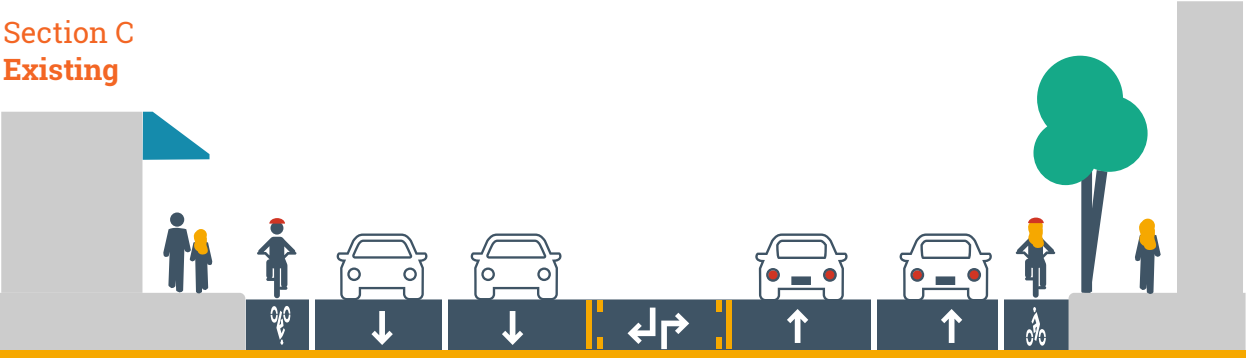

Section C Proposed

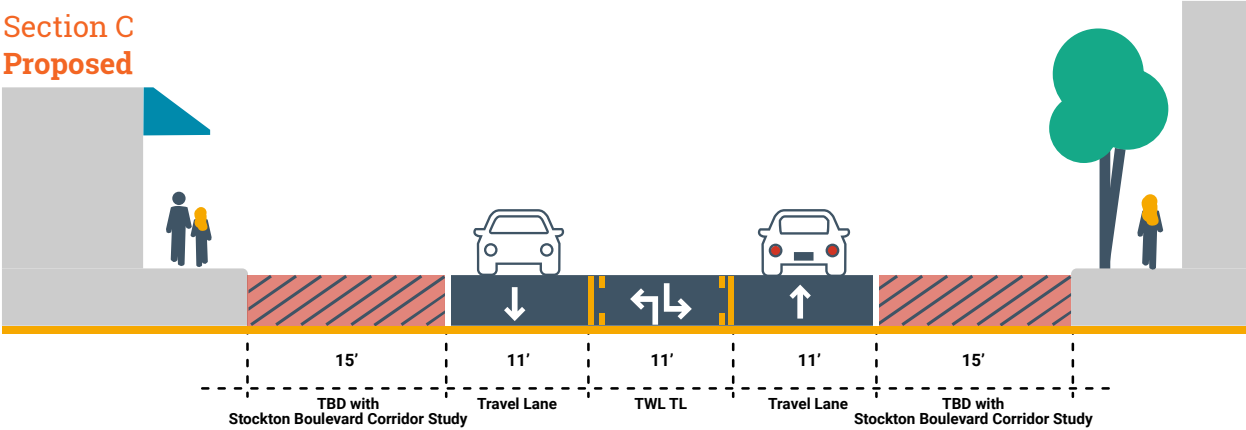

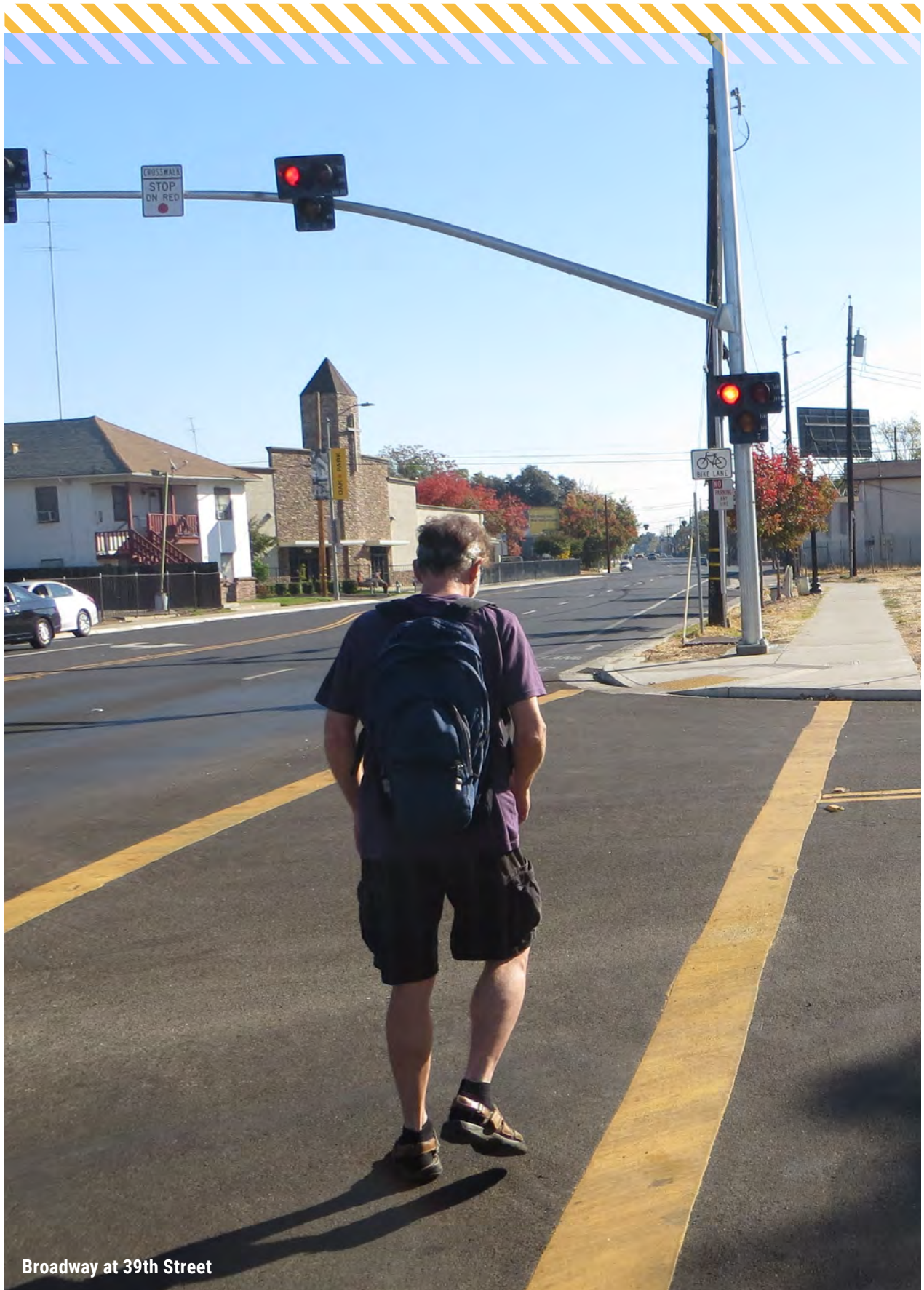

Broadway at 39th Street

Conceptual Design for Broadway

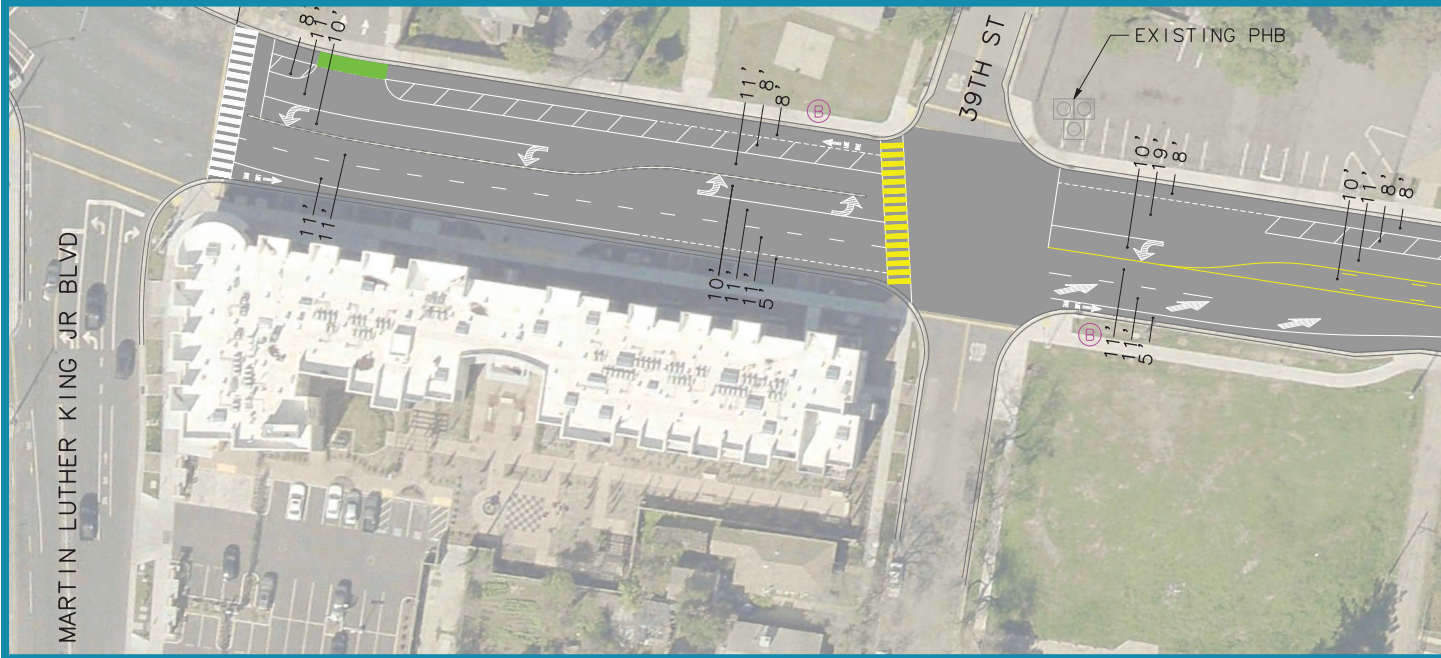

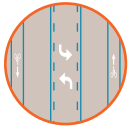

Road Diet

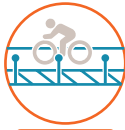

Separated Bikeway

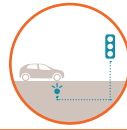

Advanced Dilemma-Zone Detection



High Visibility Crosswalk

Corridor-Wide Recommendations

Location-Specific Recommendations



Conceptual Design for Broadway

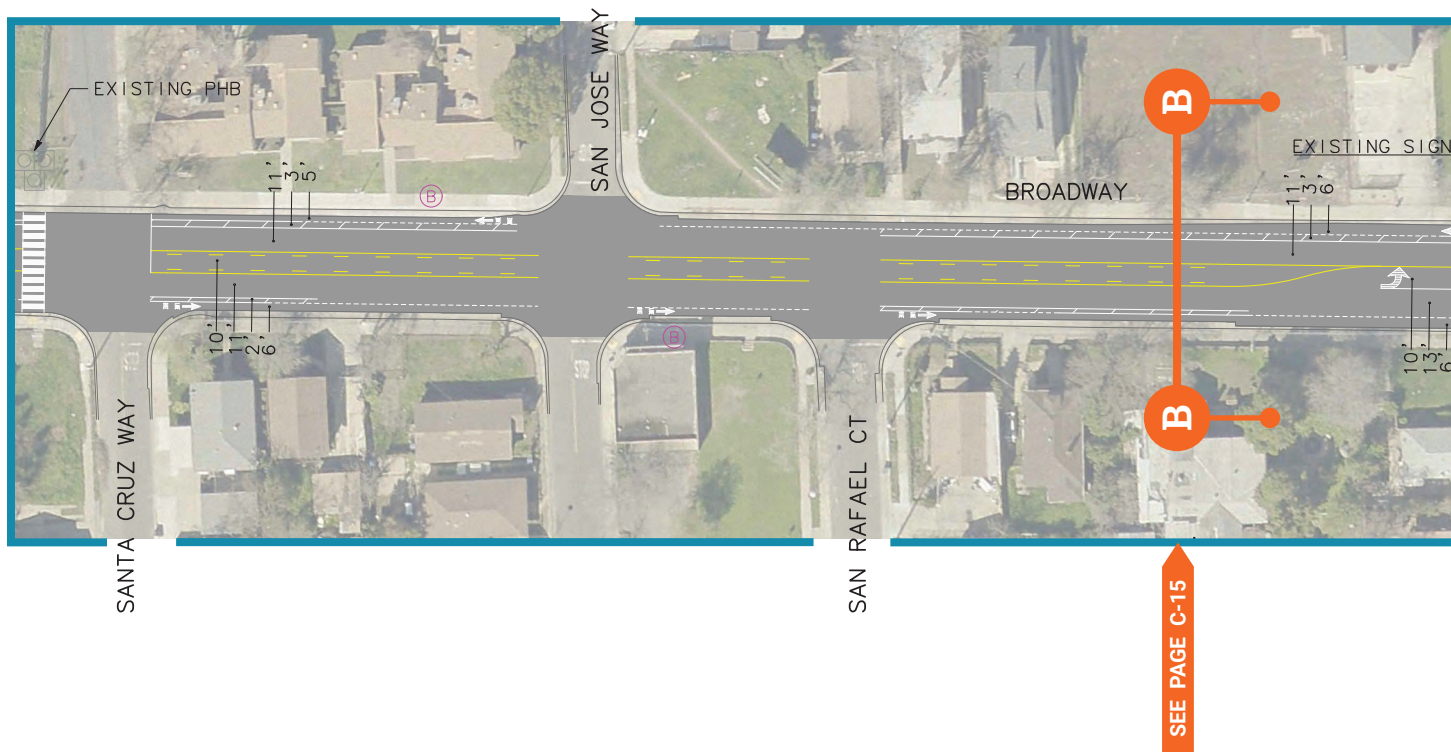

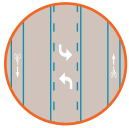

Road Diet

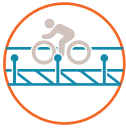

Separated Bikeway

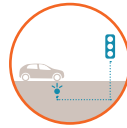

Advanced Dilemma-Zone Detection



High Visibility Crosswalk

Corridor-Wide Recommendations

Location-Specific Recommendations

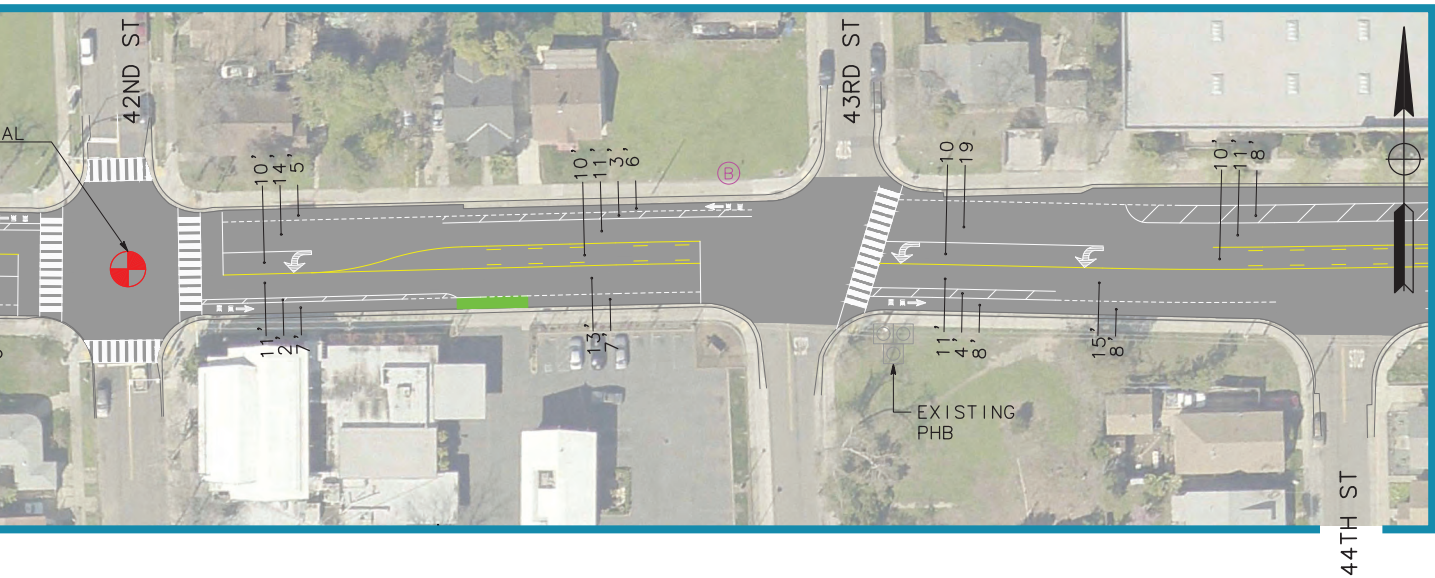

Conceptual Design for Broadway

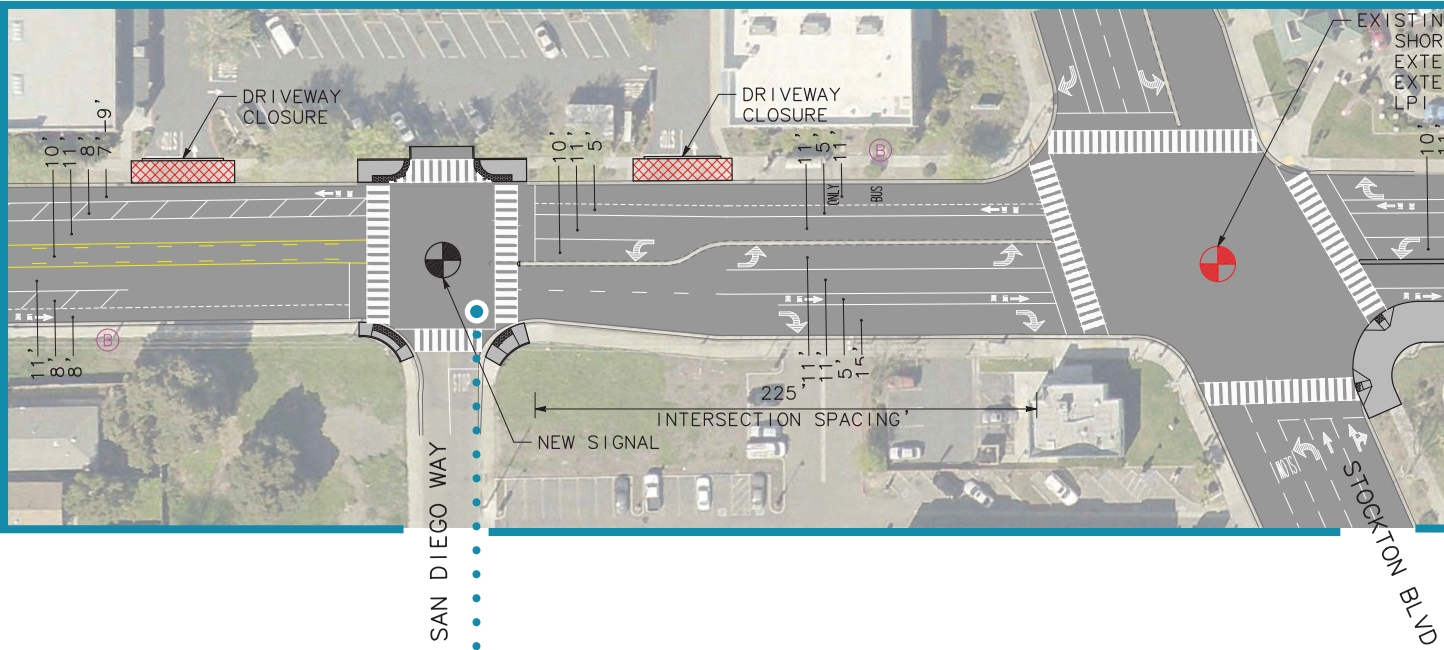

Consolidate Driveways



New Traffic Signal

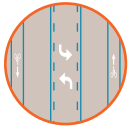

Road Diet

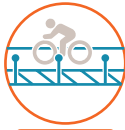

Separated Bikeway

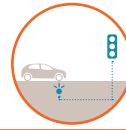

Advanced Dilemma-Zone Detection



High Visibility Crosswalk

Corridor-Wide Recommendations

Location-Specific Recommendations

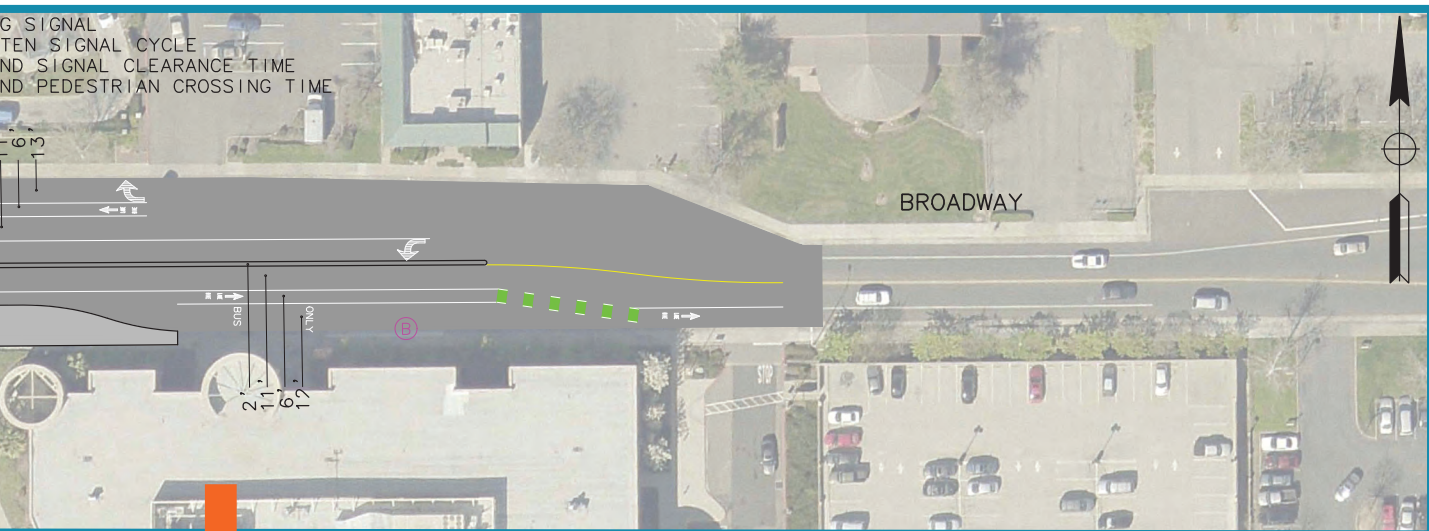

The Vision Zero recommendations include installation of traffic signals at Broadway/San Diego Way and Stockton Boulevard/6th Avenue. This would give pedestrians more opportunities to cross Broadway and Stockton Boulevard at desirable locations. However, City standard for minimum intersection spacing is 250-feet. The traffic signals at Broadway/San Diego Way and Stockton/6th Avenue would be 225-feet from the Broadway/Stockton Boulevard intersection, so the City would need to make exceptions to its Street Design Standards for this location. Traffic signals at these locations add more opportunities for controlled pedestrian crossings for popular pedestrian desire lines.

Conceptual Design for Stockton

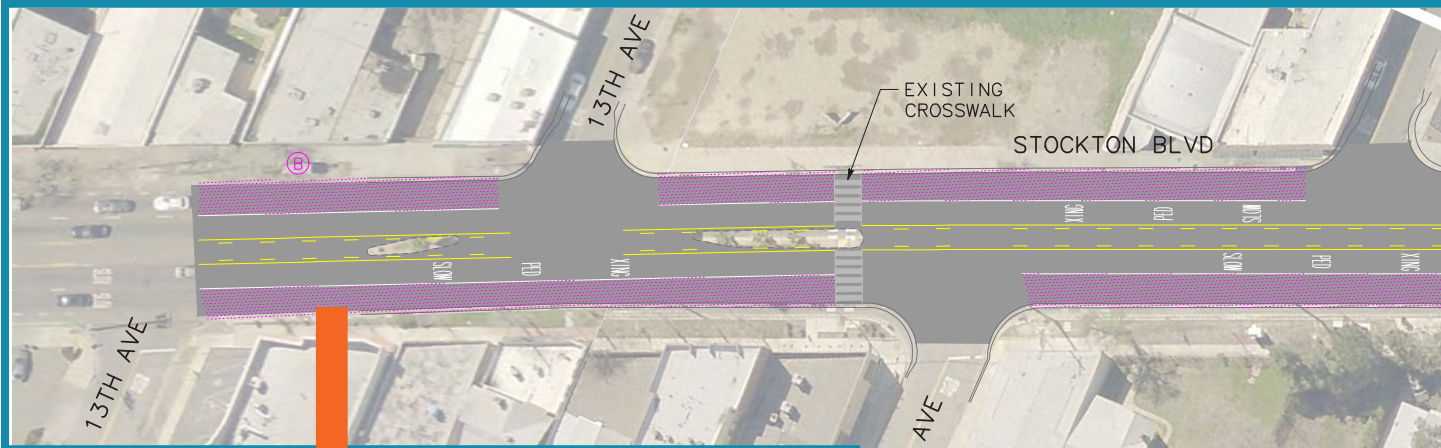

Specific use of shaded area to be determined as part of on-going Stockton Boulevard Corridor Study.

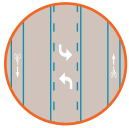

Road Diet



Separated Bikeway



Co-locate Bus Stop and Crosswalk



Bus Boarding Islands

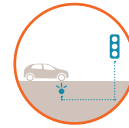

Advanced Dilemma-Zone Detection

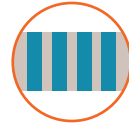

High Visibility Crosswalk

Corridor-Wide Recommendations

Location-Specific Recommendations

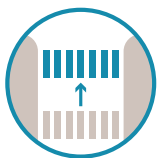
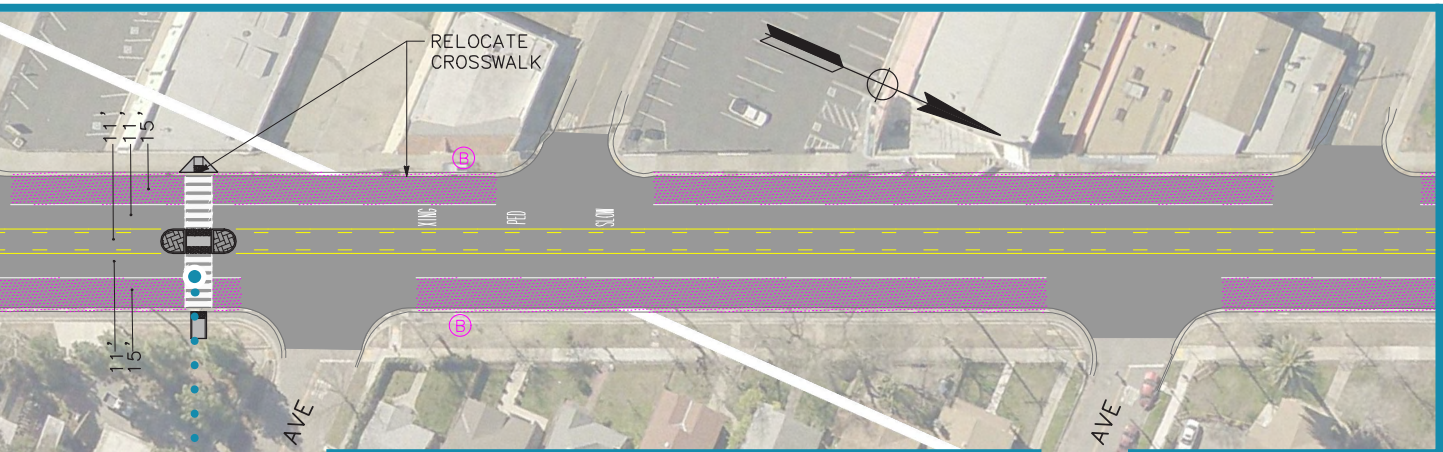

Relocate Crosswalk

Conceptual Design for Stockton

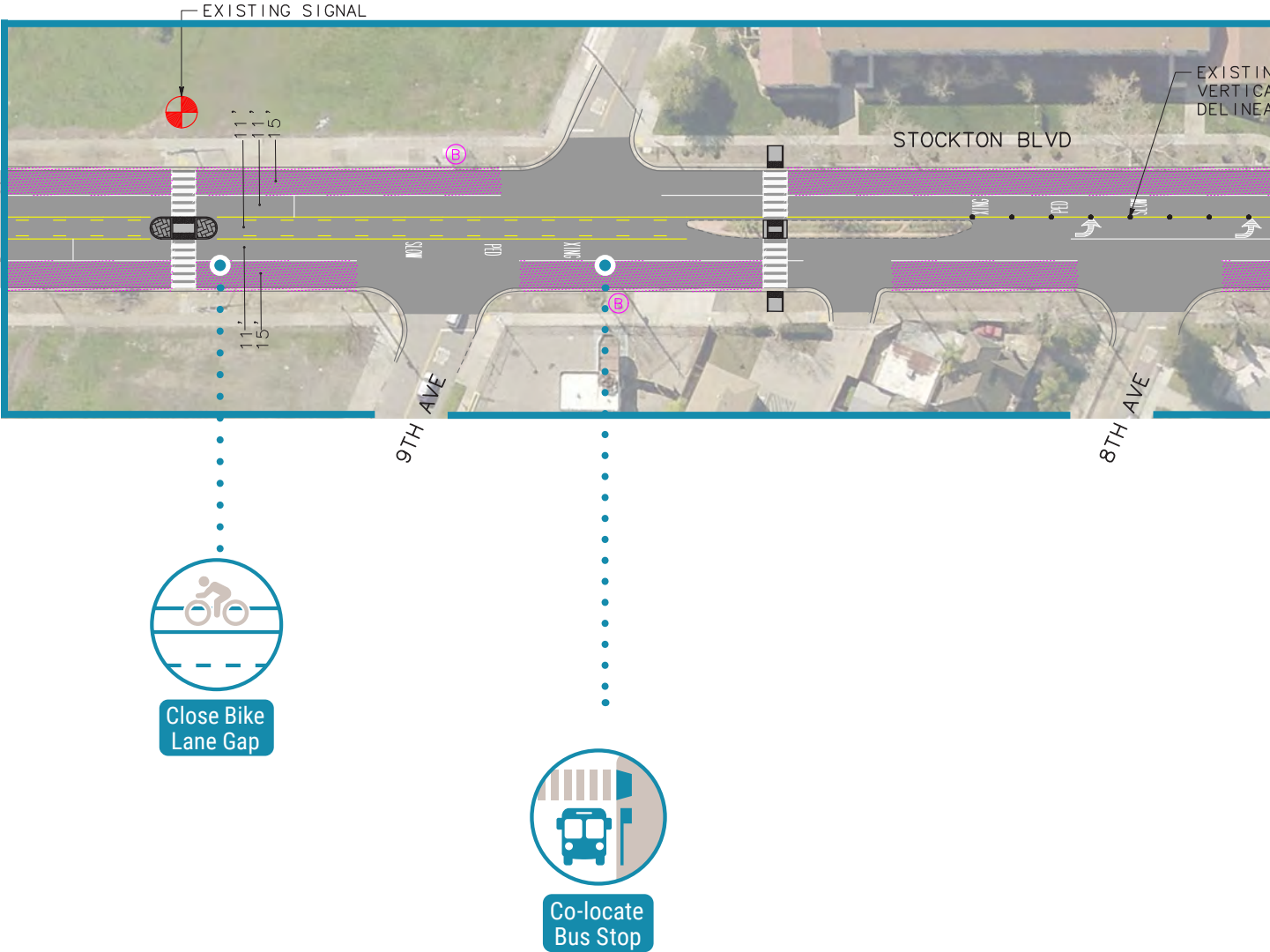

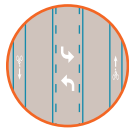

Road Diet

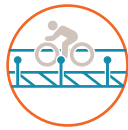

Separated Bikeway



Co-locate Bus Stop and Crosswalk



Bus Boarding Islands

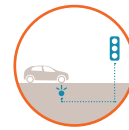

Advanced Dilemma-Zone Detection



High Visibility Crosswalk

Corridor-Wide Recommendations

Location-Specific Recommendations

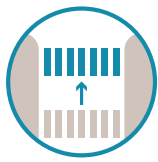

Relocate Crosswalk



New Traffic Signal

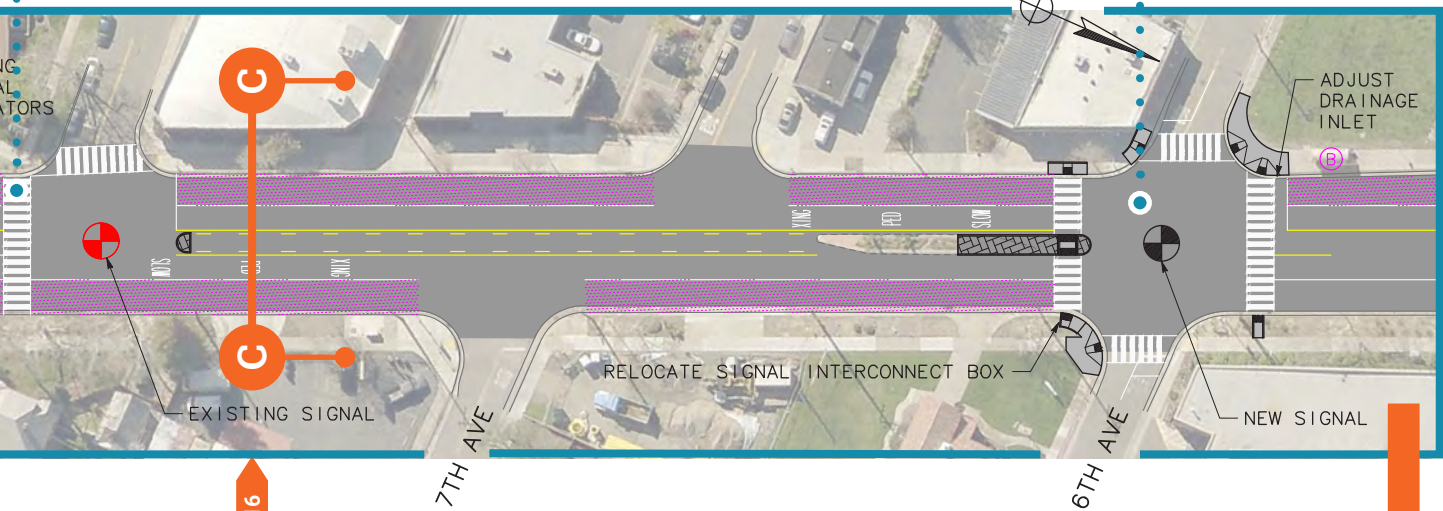

The Vision Zero recommendations include installation of traffic signals at Broadway/San Diego Way and Stockton Boulevard/6th Avenue. This would give pedestrians more opportunities to cross Broadway and Stockton Boulevard at desirable locations. However, City standard for minimum intersection spacing is 250-feet. The traffic signal at Broadway/San Diego Way would be 260-feet from the Broadway/Stockton Boulevard intersection. The traffic signal at Stockton/6th Avenue would be 225-feet from the Broadway/Stockton Boulevard intersection, so the City would need to make an exception to its Street Design Standards for this location

Conceptual Design for Stockton

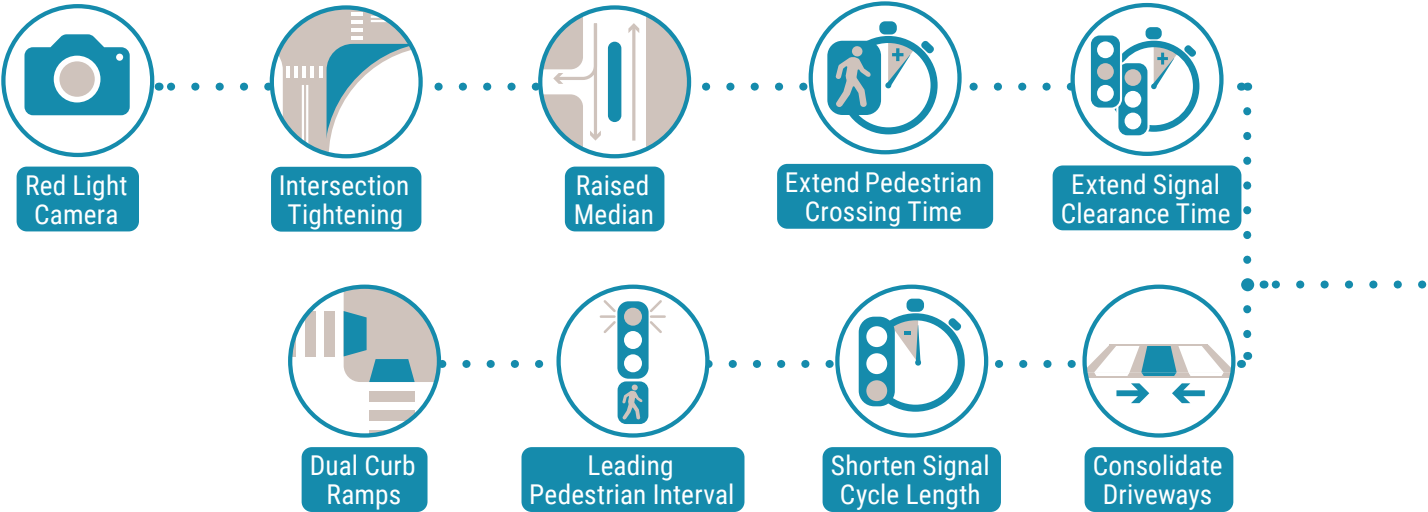

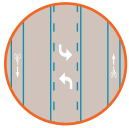

Road Diet



Separated Bikeway



Co-locate Bus Stop and Crosswalk



Bus Boarding Islands

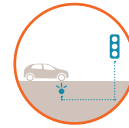

Advanced Dilemma-Zone Detection

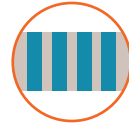

High Visibility Crosswalk

Corridor-Wide Recommendations

Location-Specific Recommendations

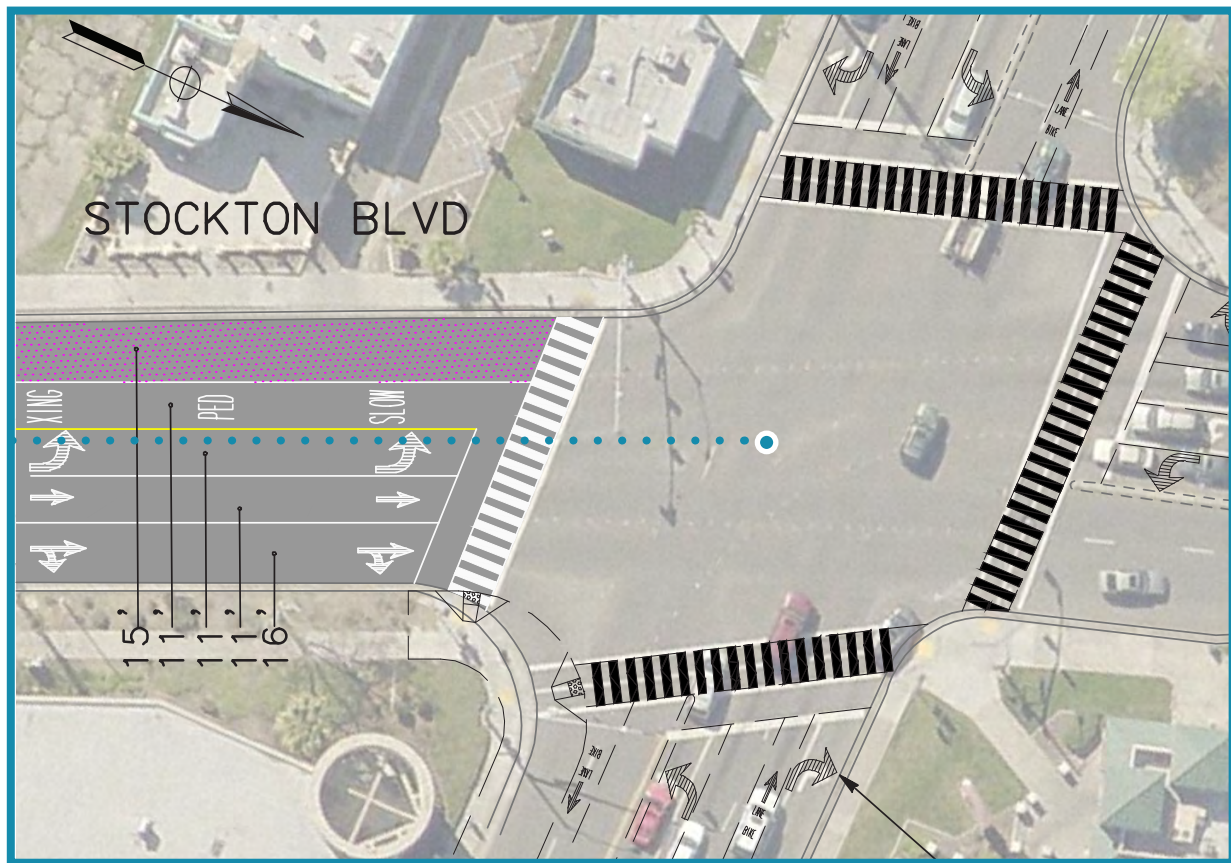

BROADWAY

How Will Travel Change on Broadway?

Estimated Changes with Project

Average Vehicle Speed

Average vehicle speed along the corridor during peak periods is expected to decrease between 1 and 5 mph as a result of the proposed project. While slower travel speeds result in longer travel times, they reduce traffic fatalities and severe injuries that result from crashes.

Eastbound



Westbound

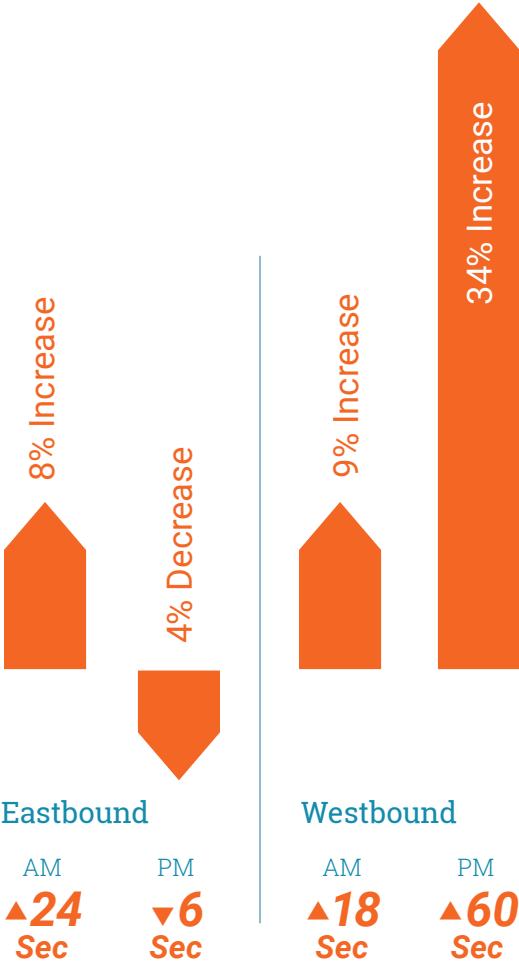

Vehicle Travel Time

Average vehicle travel time along the one-mile corridor during peak periods is expected to change ranging from a 6 second decrease to a 60 second increase seconds as a result of the proposed project.

Estimated Changes with Project

Bike Lane Coverage

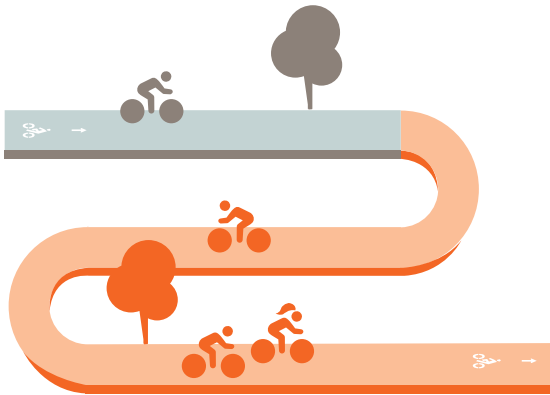

Without project
30%
(2,180 ft)

▶

With project
100%
(7,240 ft)

Share of Bike Lanes with Vertical Separation

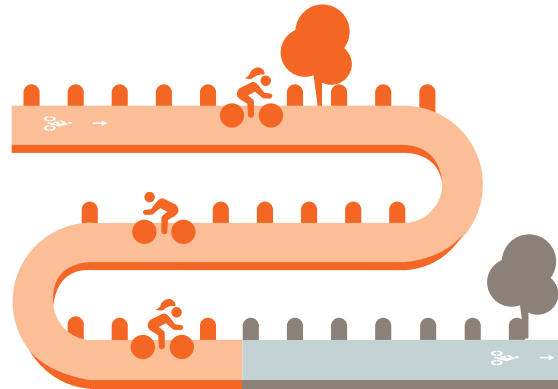

Without project
0%
(0 ft)

▶

With project
72%
(5,200 ft)

Typical Pedestrian Crossing Width

2/3 of the existing width

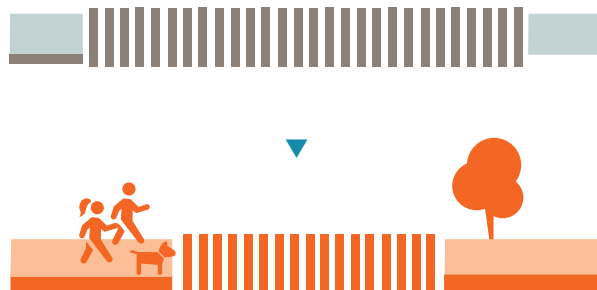

Number of Marked Crosswalks

4 new crossings

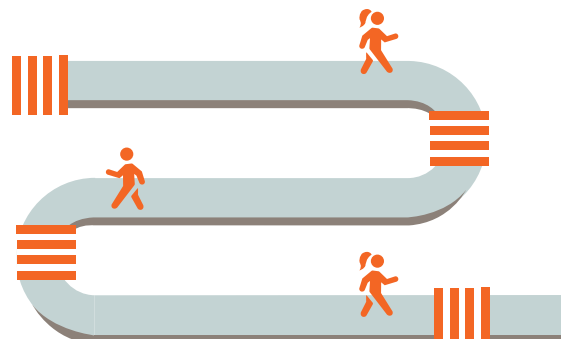

*Longest pedestrian crossing width reduced from 49 to 31 ft.

How Will Travel Change on Stockton?

Estimated Changes with Project

Average Vehicle Speed

Average vehicle speed along the corridor during peak periods is expected to decrease between 0 and 4 mph as a result of the proposed project. While slower travel speeds result in longer travel times, they reduce traffic fatalities and severe injuries that result from crashes.

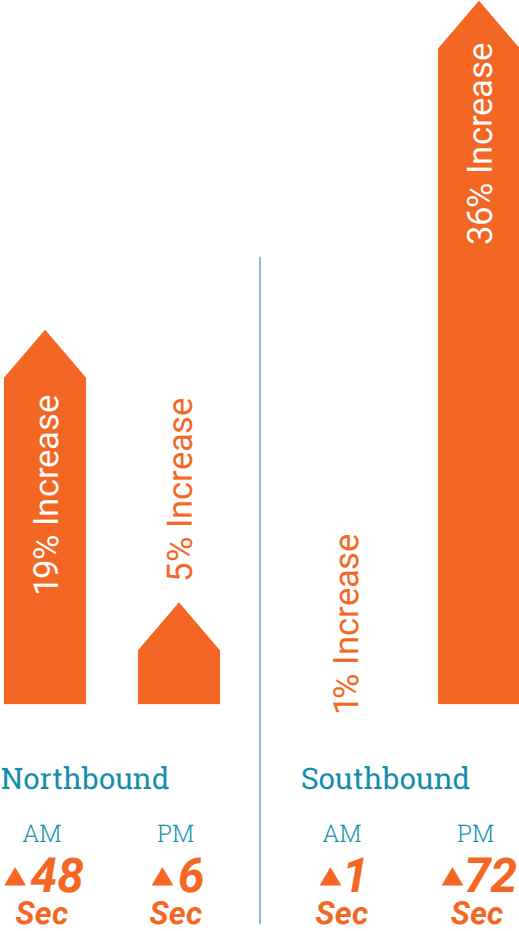
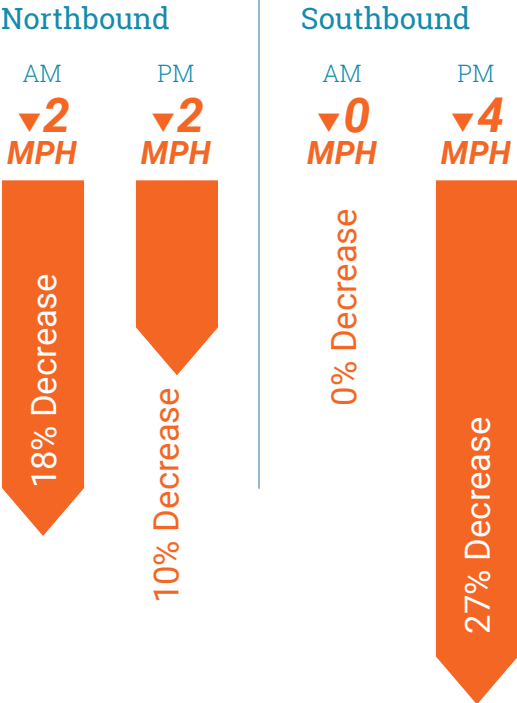

Vehicle Travel Time

Average vehicle travel time along the one-mile corridor during peak periods is expected to increase up to 72 seconds as a result of the proposed project.

Estimated Changes with Project

Longest Distance Between Crosswalks

1/4 of the existing distance

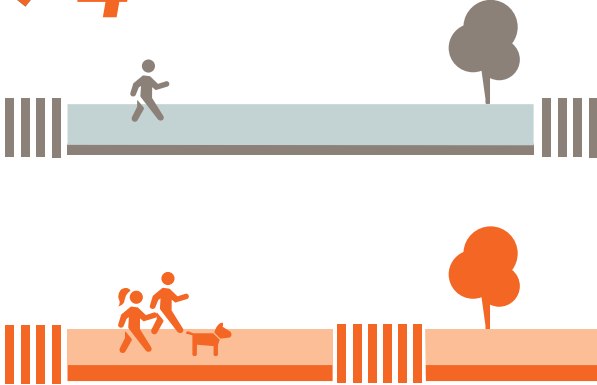

Number of Marked Crosswalks

6 new crossings

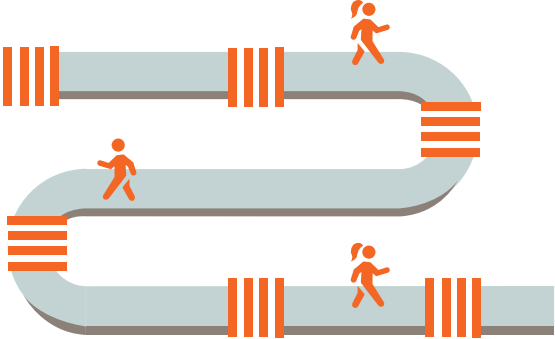

*Longest pedestrian crossing distance reduced from 780 to 200 ft.

How Much Will the Project Cost?

Broadway/Stockton Boulevard Cost Summary

\$8,760,000

Construction

Construction costs include the cost to build the primary items associated with the safety countermeasures for the corridor. The items were estimated based on the preliminary design concepts and recent construction bid unit costs with an escalation factor to account for future construction. The costs were broken down into two categories that consisted of major roadway items and electrical items such as traffic signals and lighting. A contingency factor was included to account for refinement of project design, changes in project details, or unforeseen changes in construction costs.

Actual project costs will be determined by surveyed base mapping, geotechnical reports, concept refinement, environmental reviews, right of way availability, project phasing, and bid conditions at the time of advertisement. Project costs should be reviewed prior to any grant application or initiation of a Capital Improvement Project to revalidate and update the assumptions in this study as necessary.

Right of Way

In addition to construction costs, right of way costs were assumed that include temporary construction easements for items such driveway modifications, curb ramps reconstruction, signal equipment poles and cabinets. It was assumed that each project could be constructed almost exclusively within the roadway prism and right of way acquisition would not be needed along the entire project frontage. Further refinement of the base mapping in subsequent phases of design will more accurately identify specific right of way needs.

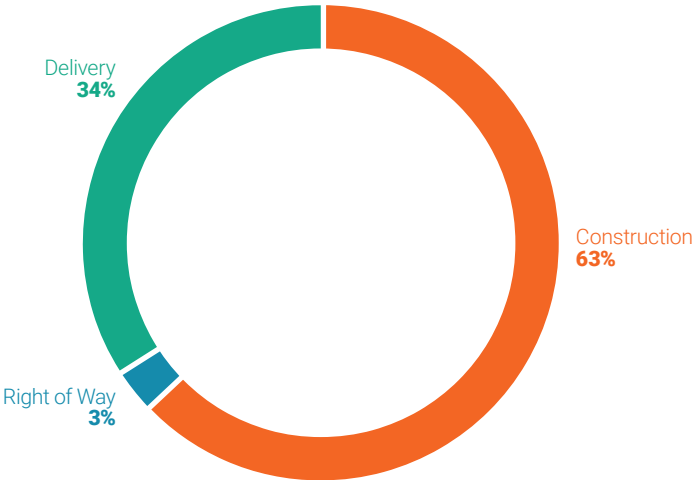

The total project costs shown in the summary chart have been escalated at an assumed 3% per year escalation factor to 2025, the anticipated year of construction.

Delivery

Project delivery costs are included in the estimates provided in this study. These costs encompass all of the work to complete subsequent phases including preliminary engineering, environmental documentation, final design, right of way engineering, and construction oversight. A breakdown of these costs is provided in Appendix C.



Stockton (South)

Vision Zero
Top 5 Corridor

Stockton Boulevard (South)

Vision Zero Top 5 Corridor



South Stockton Blvd - Vinh Phat Supermarket

What is going on?

Between 2009 and 2017, 16 crashes that resulted in a fatality or severe injury (KSI) occurred on Stockton Boulevard between McMahon Drive and Patterson Way. Nine of these crashes involved a person walking or biking.

What are the key issues?

Unsafe speed was the most commonly cited violation, while nearly three-fourths of driving were proceeding straight or stopped at the time of the crash. Additionally, nearly half of all pedestrians hit by a driver were crossing in a marked crosswalk. One-third of drivers who hit a bicyclist were making a right-turn.

What is the community concerned about?

At outreach events, residents described aggressive driving behavior along the corridor that included driving at unsafe speeds and traffic signal violations. Many residents also said they avoid biking on this segment of Stockton Boulevard because of gaps in the bike lane. The following pages lay out the existing conditions along the corridor, feedback heard from residents at outreach events, and a set of roadway safety recommendations focused on slowing drivers down, improving compliance with signals and signs, and improving safety for people walking and biking.

Table of Contents

D-4

**In the
Neighborhood**

D-6

**Travel on
Stockton (South)**

D-8

**Safety on
Stockton (South)**

D-10

**Feedback from
the Community**

D-11

**Investments to
Enhance Safety**

D-12

**Conceptual Design
for Stockton
(South)**

D-22

**How Will Travel
Change?**

D-24

**How Much Will
the Project Cost?**

In the Neighborhood

Corridor



About the Neighborhood

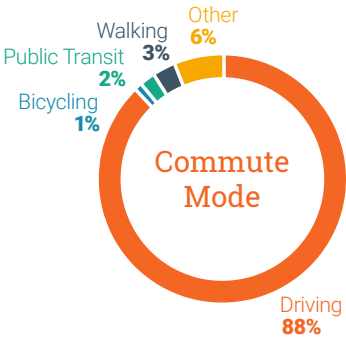

A larger share of residents drive to work in this neighborhood than in the city as a whole.

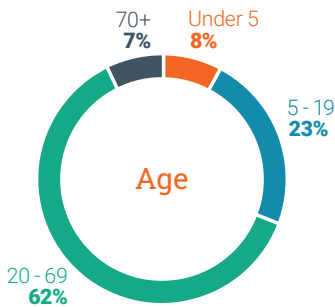

This neighborhood has a larger share of residents age 19 or younger, when compared with the rest of the city.

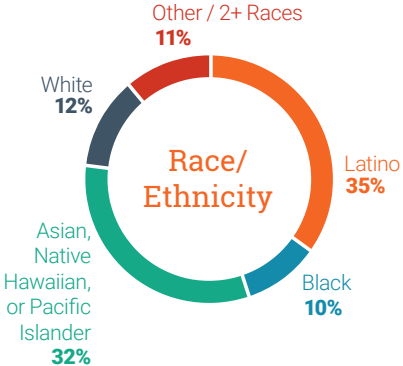

32% of residents in this neighborhood identify as Asian, Native Hawaiian, or Pacific Islander, compared with 19% of residents citywide.

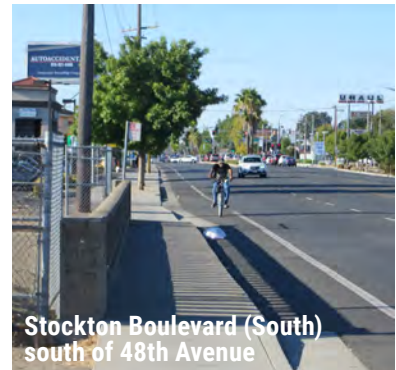

Key Destinations Along the Corridor

Schools

4 

Food Markets

5 

Houses of Worship

2 

Travel on Stockton (South)

Key Statistics

Posted Speed Limit

40
MPH

Daily Vehicles

29,700

Maximum PM Intersection Vehicle Volume

2,116

PM Rush Hour People Walking

121

PM Rush Hour People Biking

96

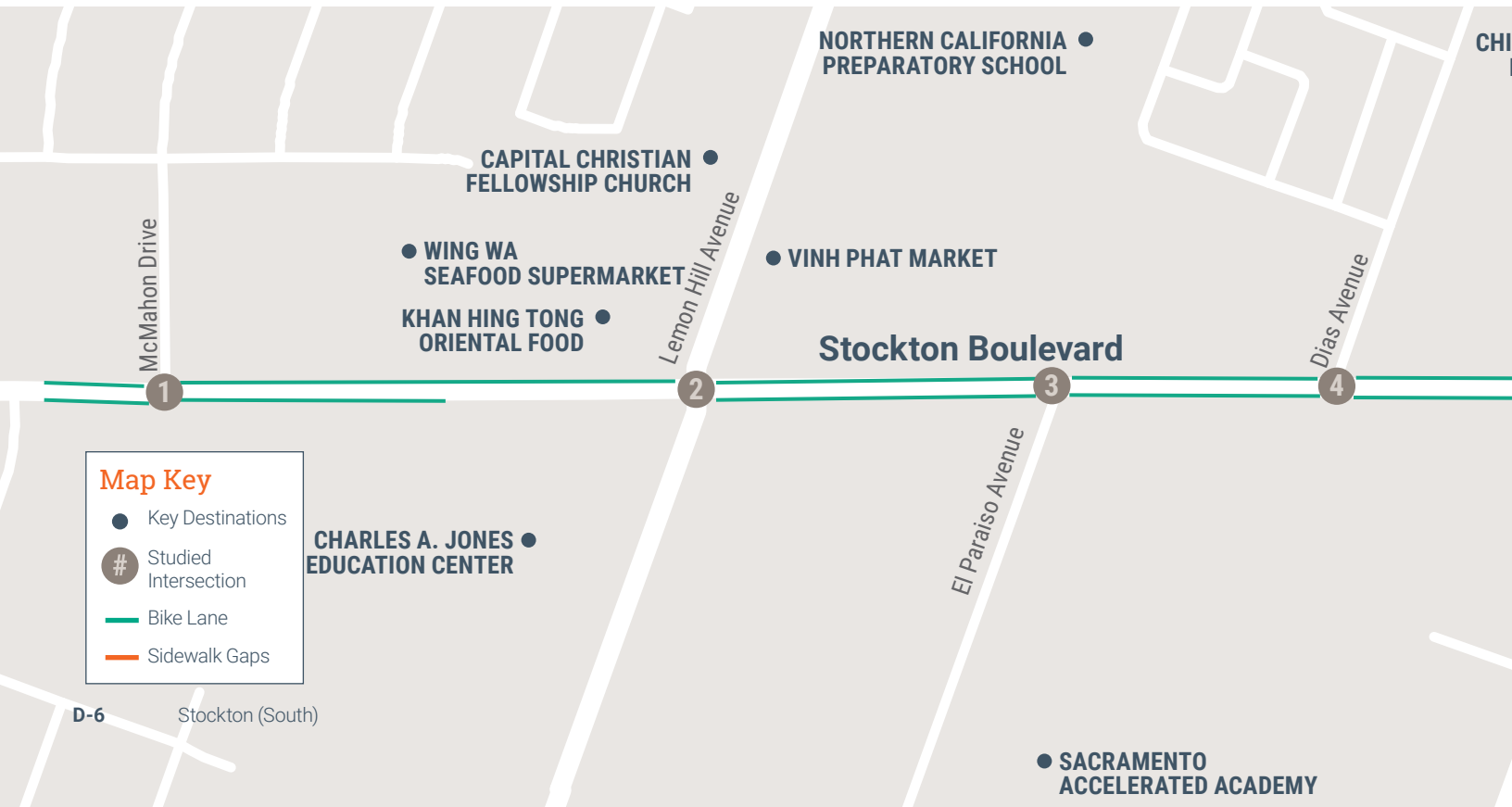
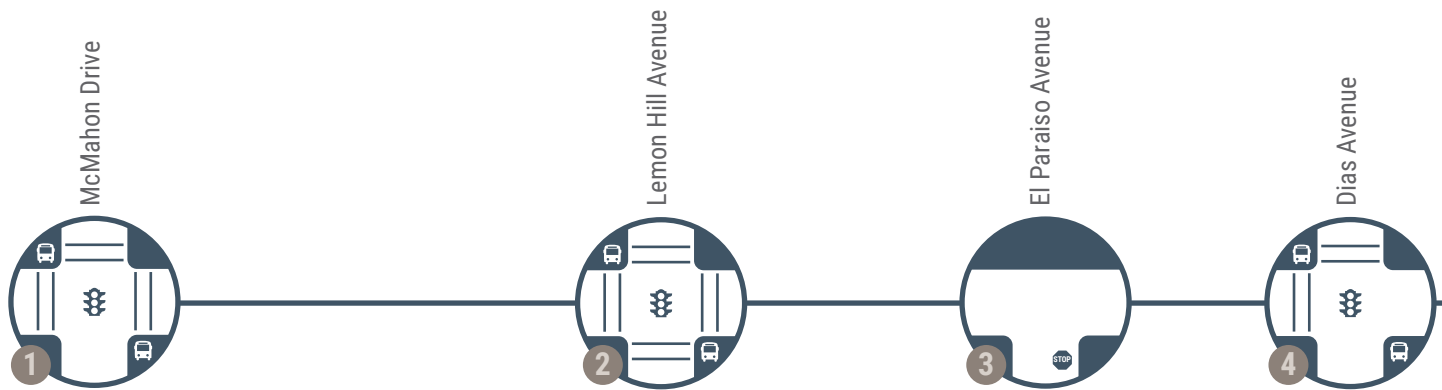

Map Key

- Key Destinations
- # Studied Intersection
- Bike Lane
- Sidewalk Gaps

Number of
Transit Routes

1
#51

Bikeway
Type

**On-Street
Bike Lanes,
with gaps**

Longest Distance
Between Marked
Crosswalks

1,780
Ft

Sidewalk
Coverage

97%

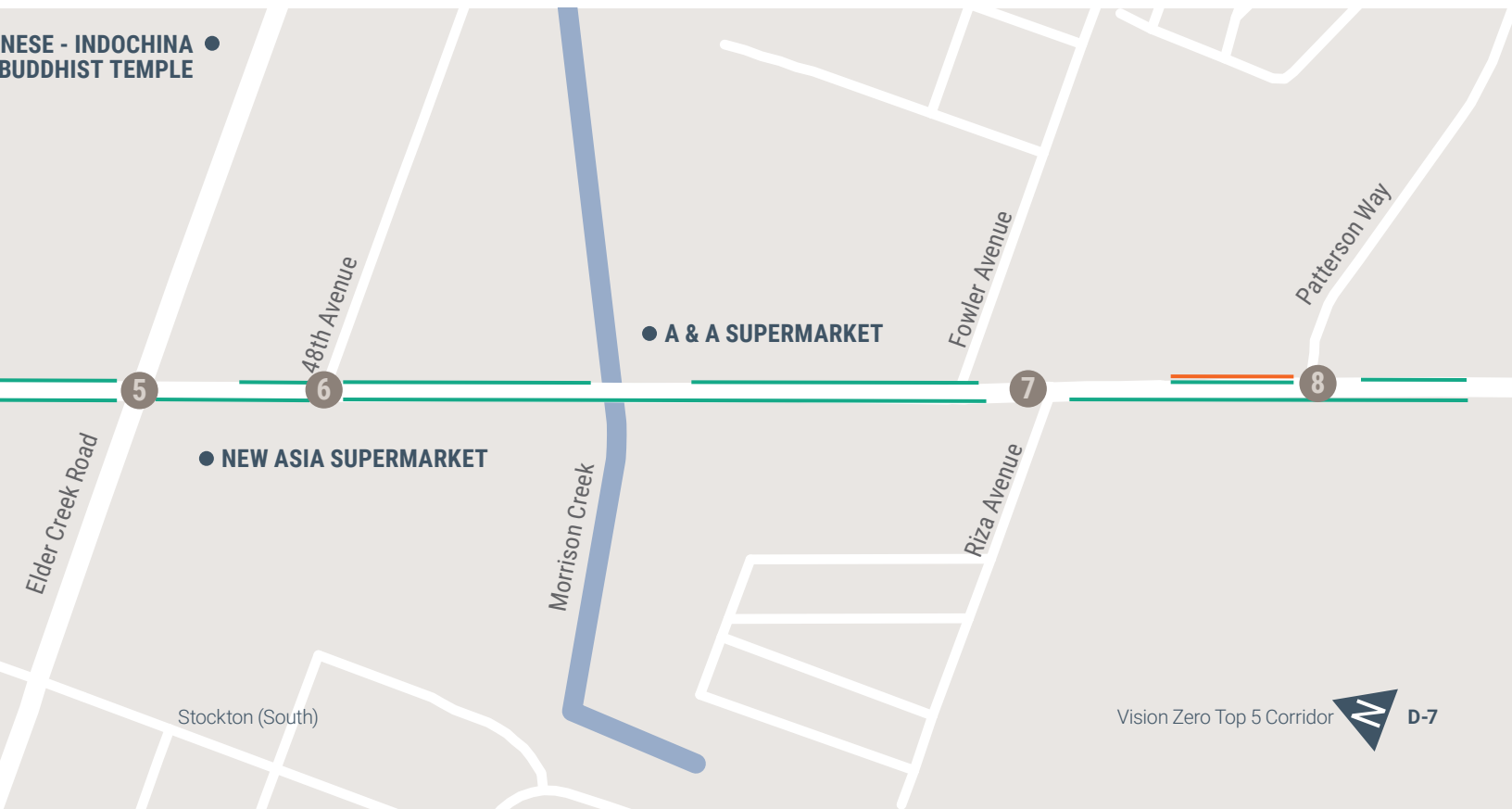

Crashes on Stockton (South)

Vehicle Crash Types

Unsafe Speed

"Unsafe Speed" was the most common violation, cited in 35% of all crashes.

1 2 3 4 5 6
7 8

Proceeding Straight

Nearly 3/4 of drivers were proceeding straight or stopped at the time of the crash.

1 2 3 4 5 6
7 8

Rear End

Over 35% of all crashes were rear end.

1 2 3 4 5 6
7 8

Crash Locations

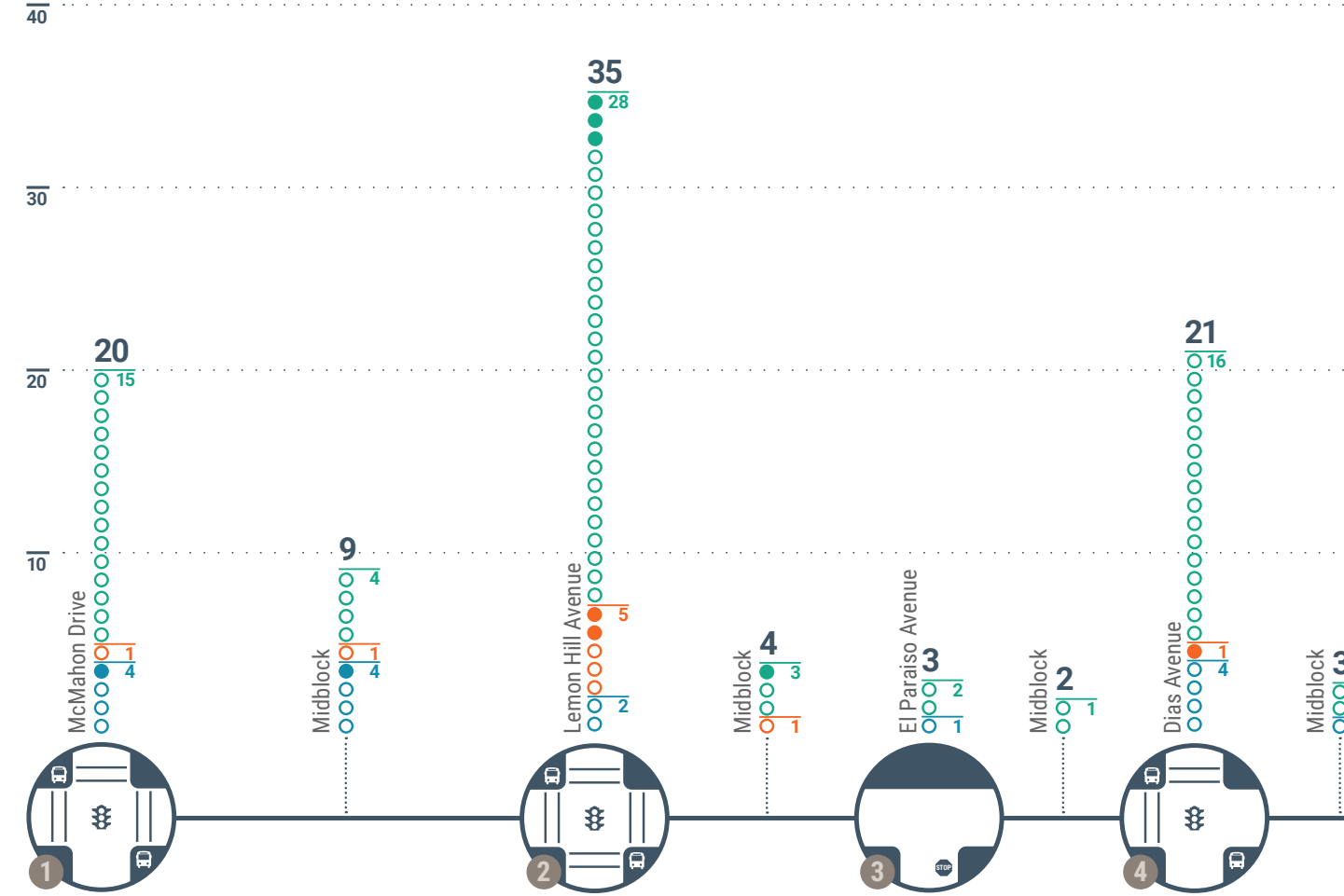

Ped Crash Types

Bike Crash Types



Nighttime

40% of all crashes occurred during nighttime or dark conditions.

1 2 3 4 5 6
7 8



Crossing in Crosswalk

Nearly half of all pedestrians hit by a driver were in a crosswalk at the time of the crash.

1 2 3 4 5 6
7 8



Right Turns

1/3 of drivers who hit a bicyclist were making a right turn at the time of the crash

1 2 3 4 5 6
7 8

1 Numbers that are turned on represent a location where crash type has occurred at least three times.

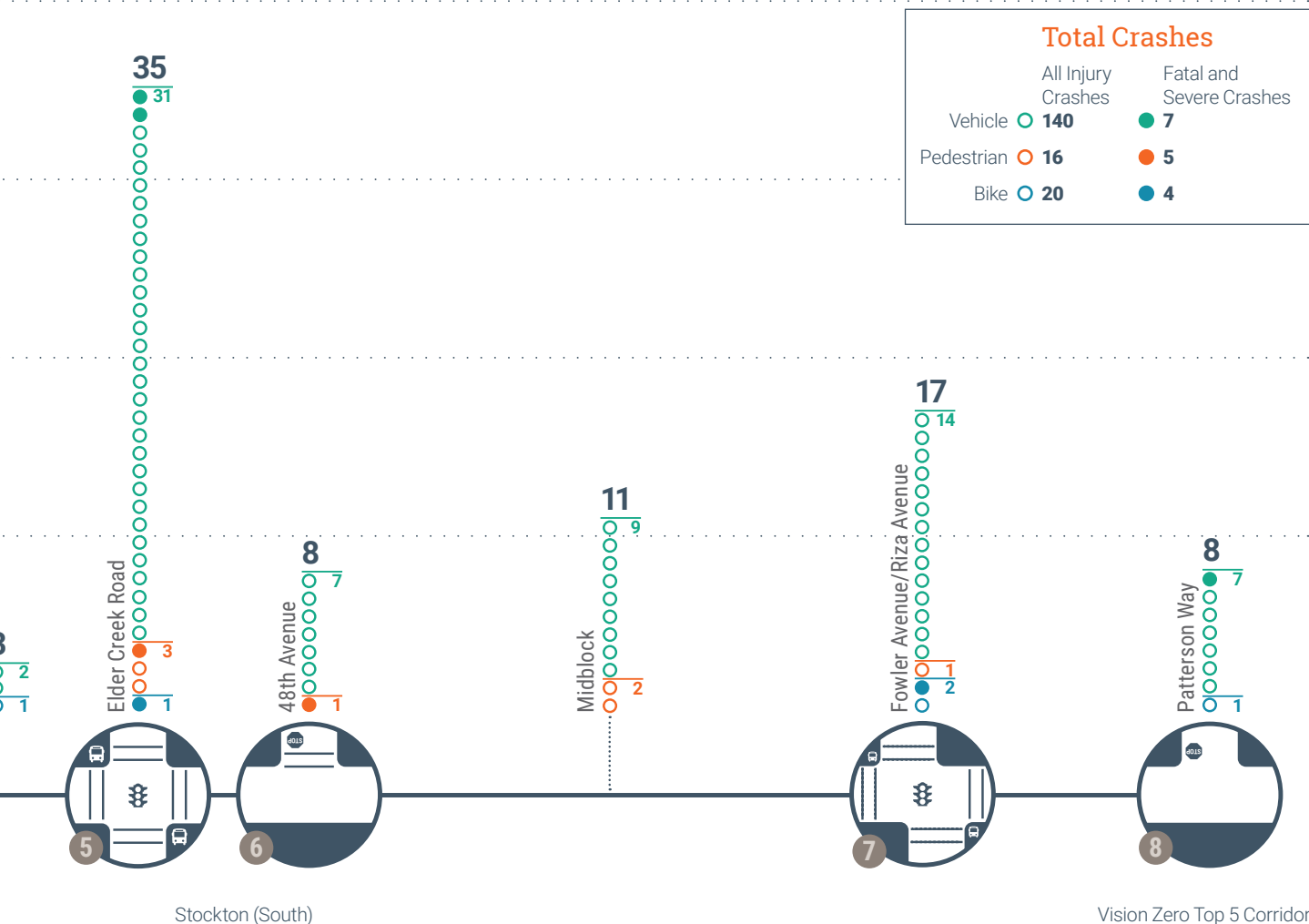

Feedback from the Community

“ I won’t ride my bike along this corridor because it feels unsafe.”

“ My grandma picks me up from school and there are a lot of fast cars.”



Peter Burnett Elementary School Community Workshop

Key Themes

Bike/Pedestrian Safety

Residents described avoiding biking on Stockton Boulevard because it feels unsafe and there is a lack of connectivity to other bike facilities.

Signals/Signage

Residents described red light running, particularly at the Stockton Boulevard/McMahon Drive intersection.

Speed

Residents described traffic speeding along the corridor.

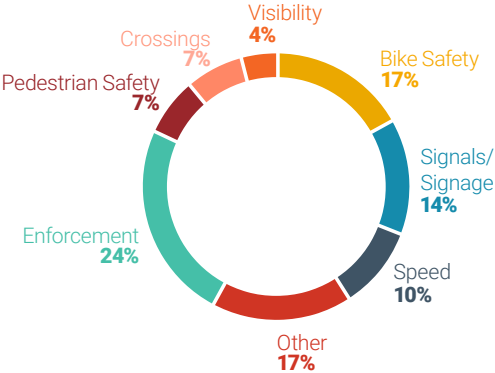







Engagement Events

November 5, 2018
Peter Burnett Elementary School
Community Workshop

June 5, 2019
Luther Burbank High School
Community Open House

Investments to Enhance Safety

Key Crash Countermeasures

Countermeasure	Crash Type	Feedback Key Theme
 <p>Slow Green Wave</p> <p>TO ADDRESS</p>	 <p>Unsafe Speed</p>	Speed
 <p>Prohibit Turns During Pedestrian Phase</p> <p>TO ADDRESS</p>	 <p>Crossing in Crosswalk</p>	Bike/Pedestrian Safety
 <p>Extend Signal Clearance Time</p> <p>TO ADDRESS</p>	 <p>Rear End</p>	Signals/Signage

How Will The Roadway Space Be Used?

Section D Existing



SEE PAGE D-17

Section D Proposed

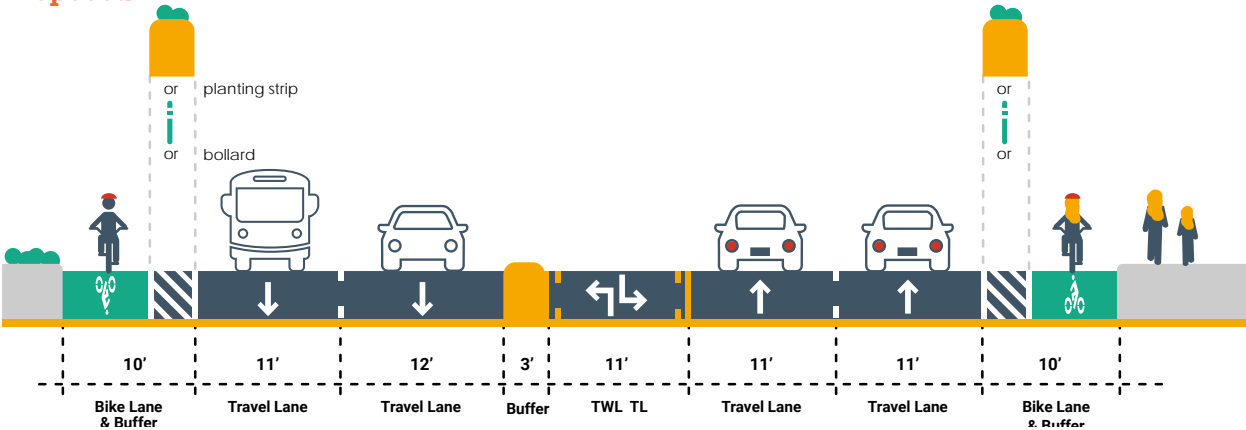

Conceptual Design for Stockton (South)





Pedestrian Scale Lighting



Advanced Dilemma-Zone Detection



Slow Green Wave



Shorten Cycle Length



Extend Signal Clearance Time



High Visibility Crosswalk

Corridor-Wide Recommendations

Location-Specific Recommendations

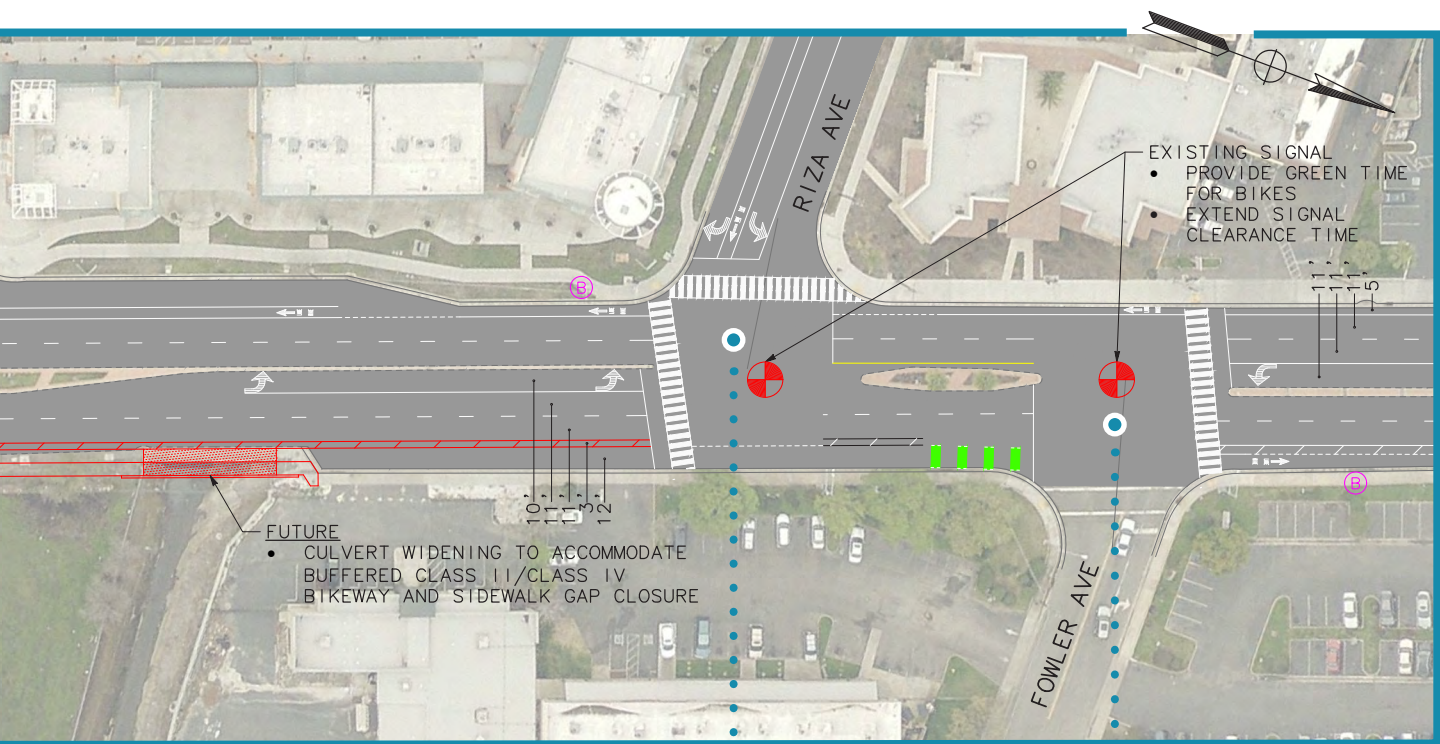

Remove Dual Left Turn Lanes

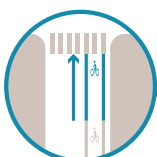

Extend Bike Lane to Intersection



Extend Signal Clearance Time



Provide Green Time For Bikes



Bike Conflict Zone Markings



Pedestrian Scale Lighting



Advanced Dilemma-Zone Detection



Slow Green Wave



Shorten Cycle Length



Extend Signal Clearance Time



High Visibility Crosswalk

Corridor-Wide Recommendations

Location-Specific Recommendations

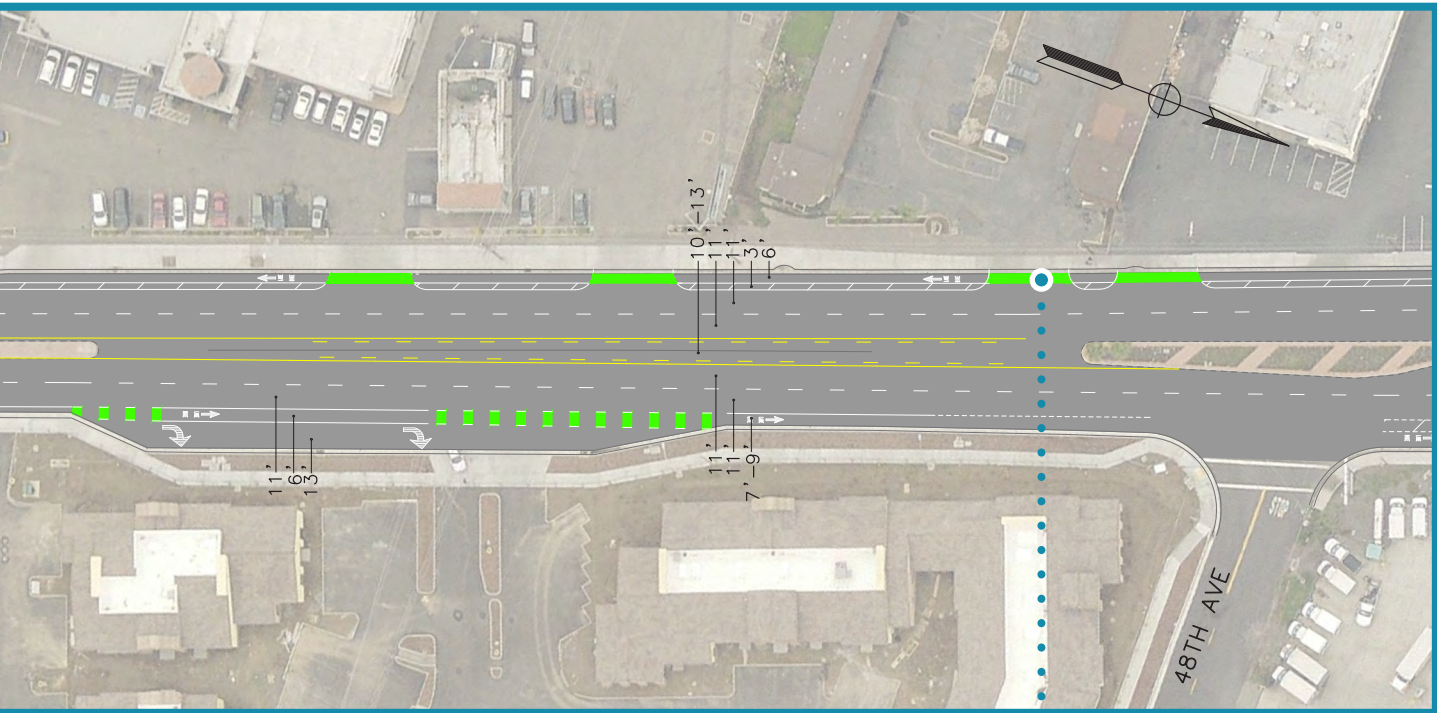

Bike Conflict Zone Markings

Conceptual Design for Stockton (South)



Remove Dual Left Turn Lanes



Pedestrian Refuge Island

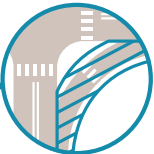

Remove Right Turn Slip Lane



Extend Pedestrian Crossing Time

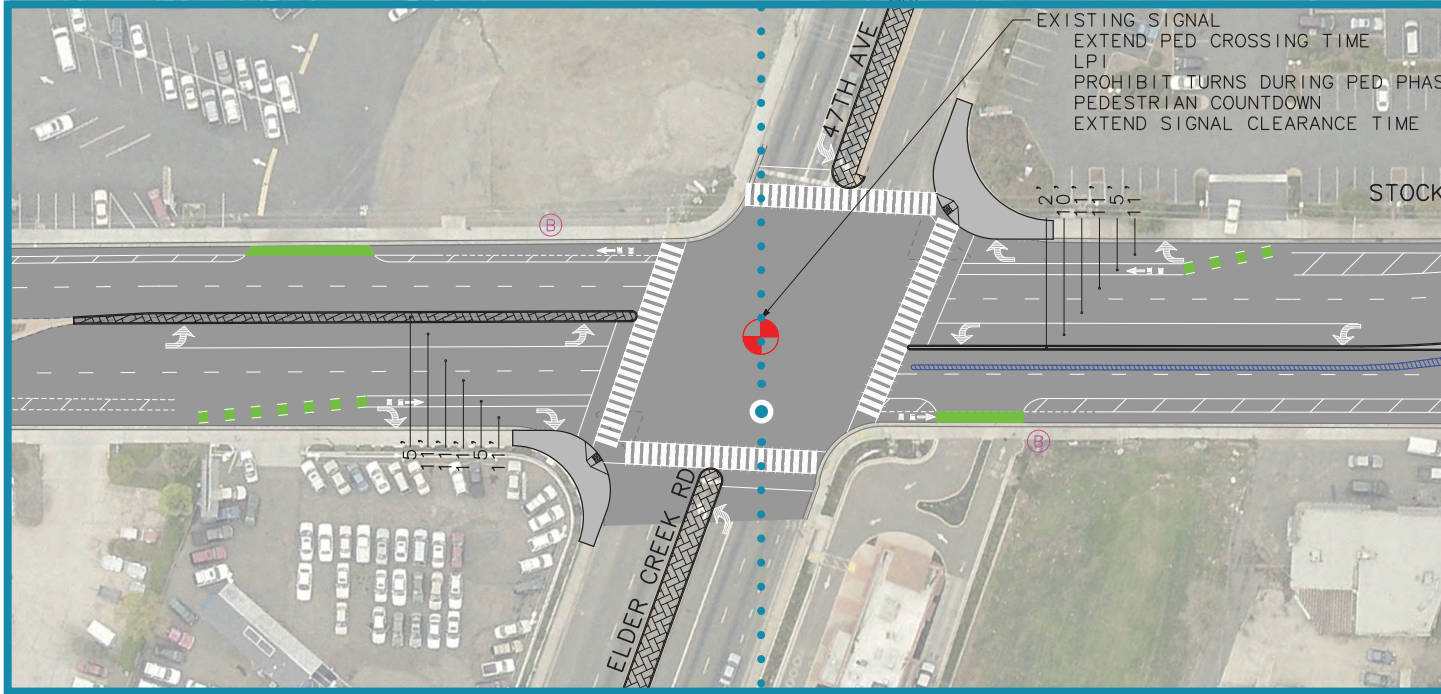

Extend Signal Clearance Time



Leading Pedestrian Interval

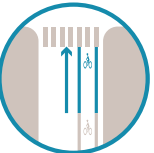

Extend Bike Lane to Intersection



Prohibit Turns During Pedestrian Phase



Remove Sight Obstruction



Pedestrian Scale Lighting



Advanced Dilemma-Zone Detection



Slow Green Wave



Shorten Cycle Length



Extend Signal Clearance Time



High Visibility Crosswalk

Corridor-Wide Recommendations

Location-Specific Recommendations

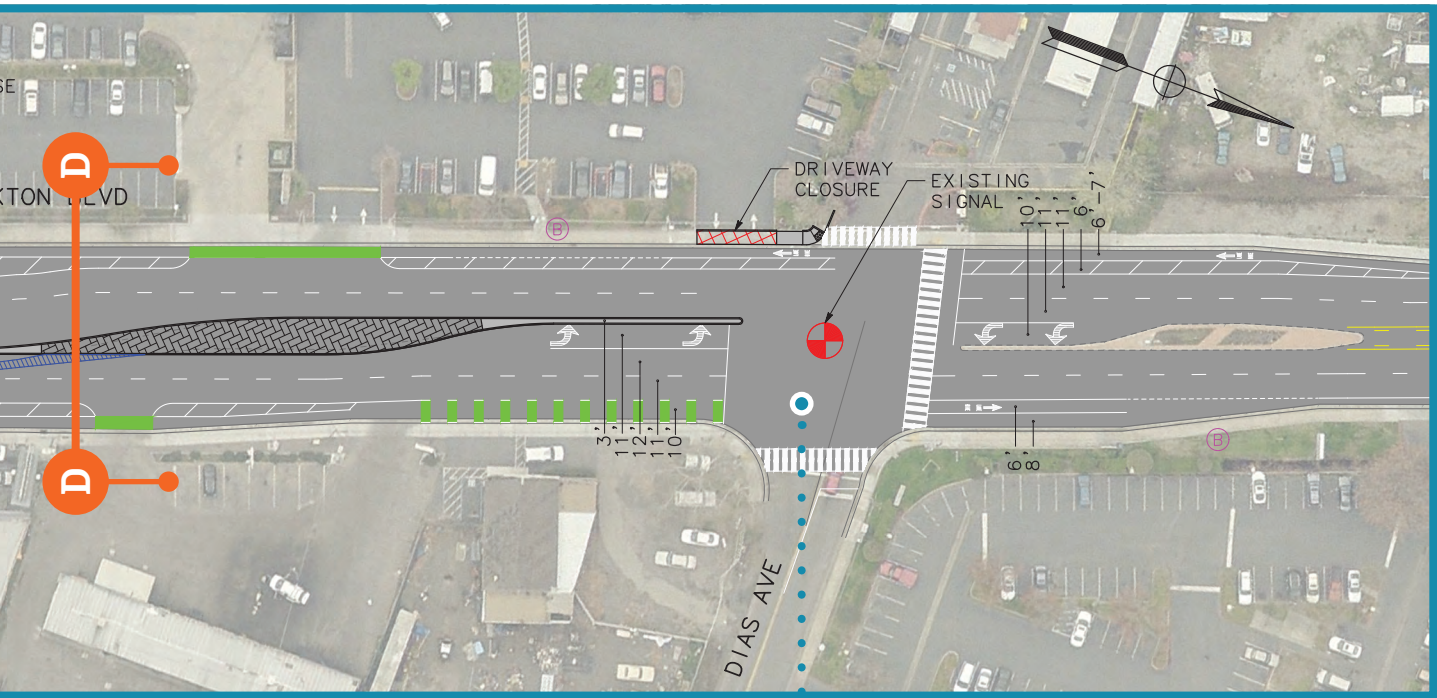

SEE PAGE D-11



Consolidate Driveways



Bike Conflict Zone Markings

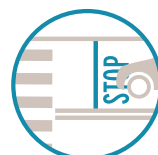

Advance Stop Bar



Stop Sign

Conceptual Design for Stockton (South)

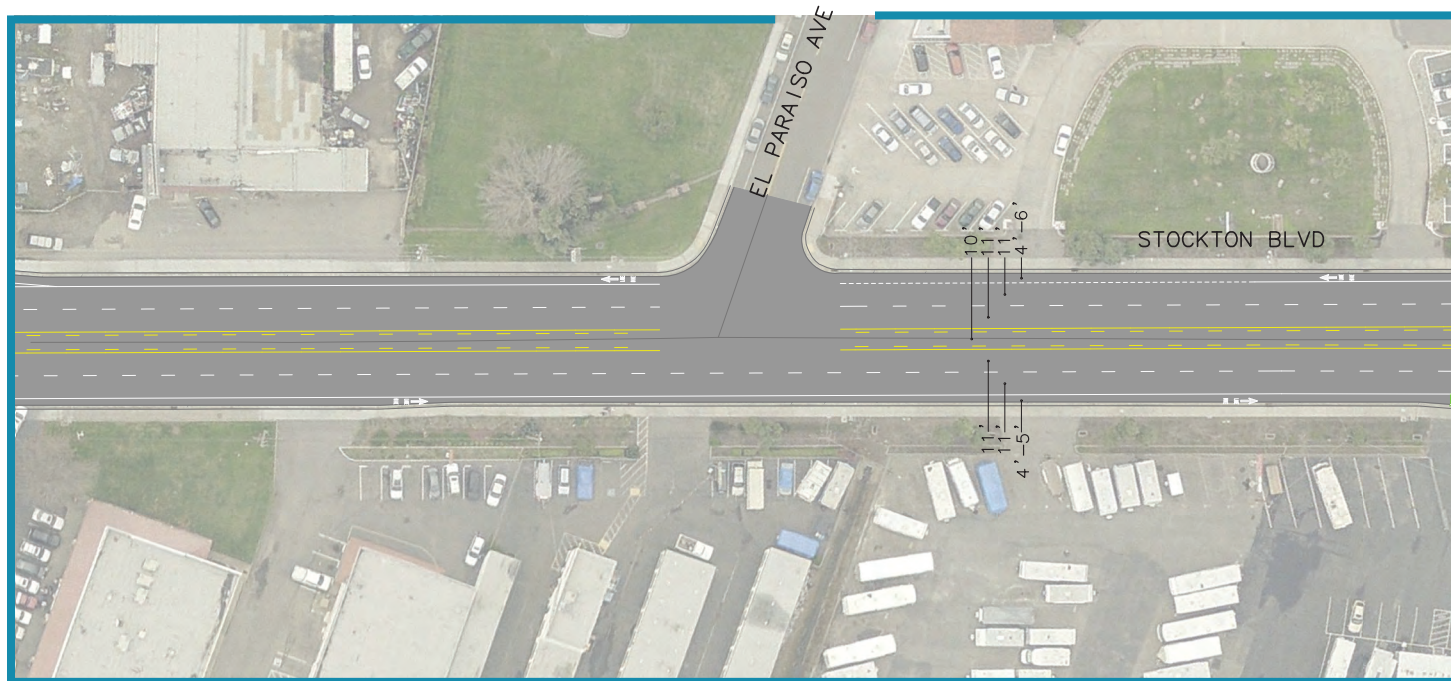

Consolidate Driveways



Extend Pedestrian Crossing Time



Remove Sight Obstruction



Shorten Signal Cycle Length



Leading Pedestrian Interval



Pedestrian Scale Lighting

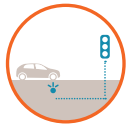

Advanced Dilemma-Zone Detection



Slow Green Wave



Shorten Cycle Length



Extend Signal Clearance Time



High Visibility Crosswalk

Corridor-Wide Recommendations



Extend Signal Clearance Time



Protected Left Turns

Location-Specific Recommendations

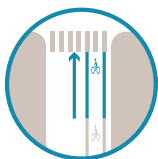
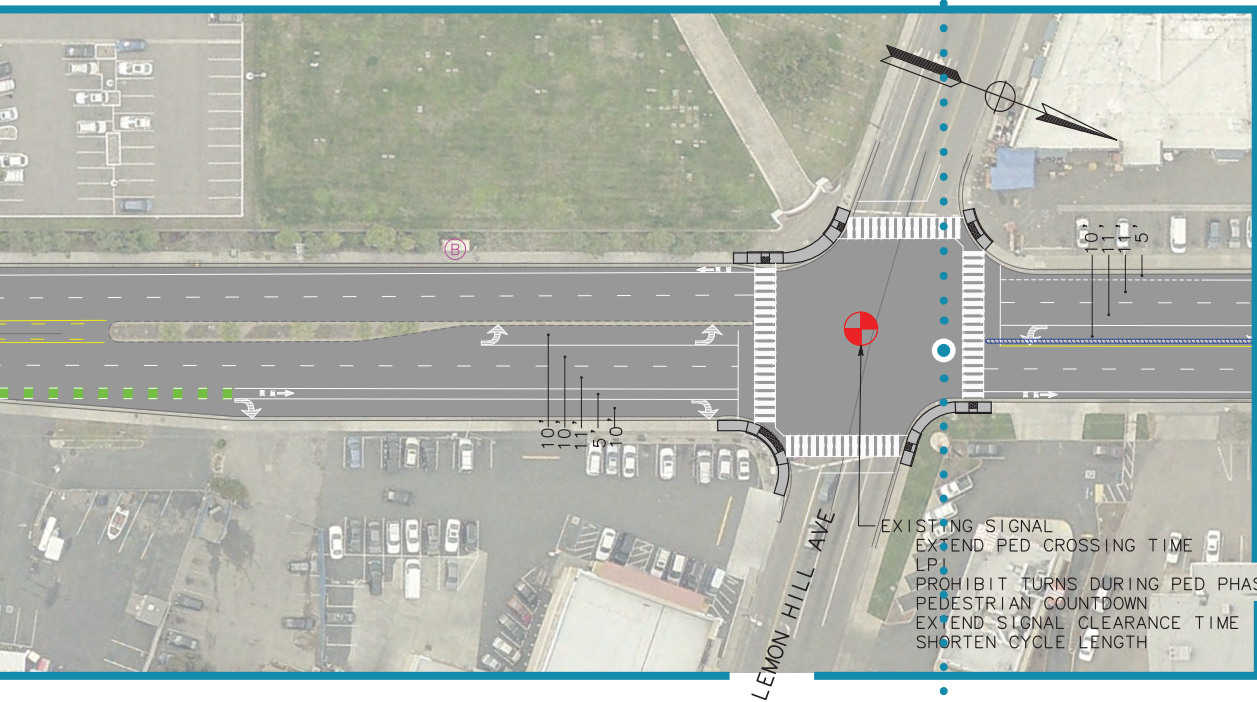

Extend Bike Lane to Intersection



Bike Conflict Zone Markings



Countdown Pedestrian Signal Heads

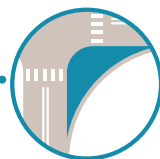

Intersection Tightening



Prohibit Turns During Pedestrian Phase

Conceptual Design for Stockton (South)

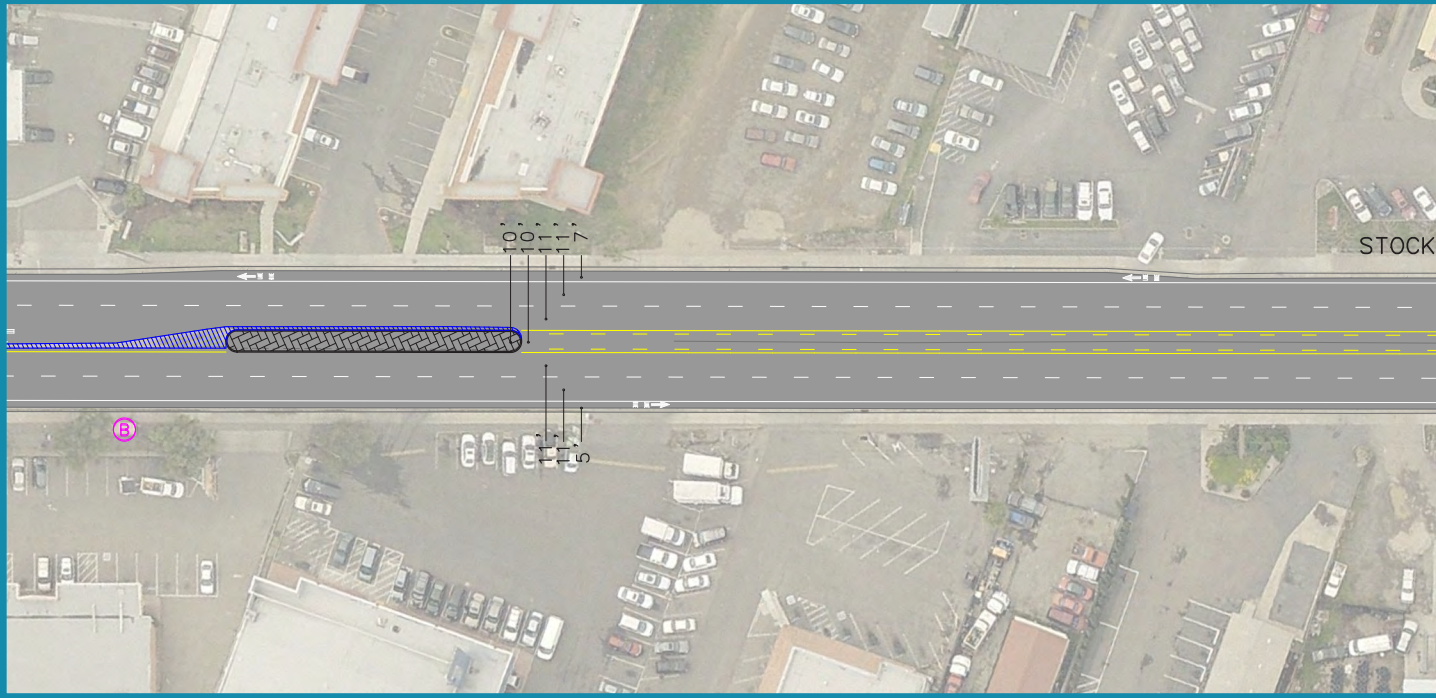



Pedestrian Scale Lighting



Advanced Dilemma-Zone Detection



Slow Green Wave



Shorten Cycle Length



Extend Signal Clearance Time



High Visibility Crosswalk

Corridor-Wide Recommendations

Location-Specific Recommendations

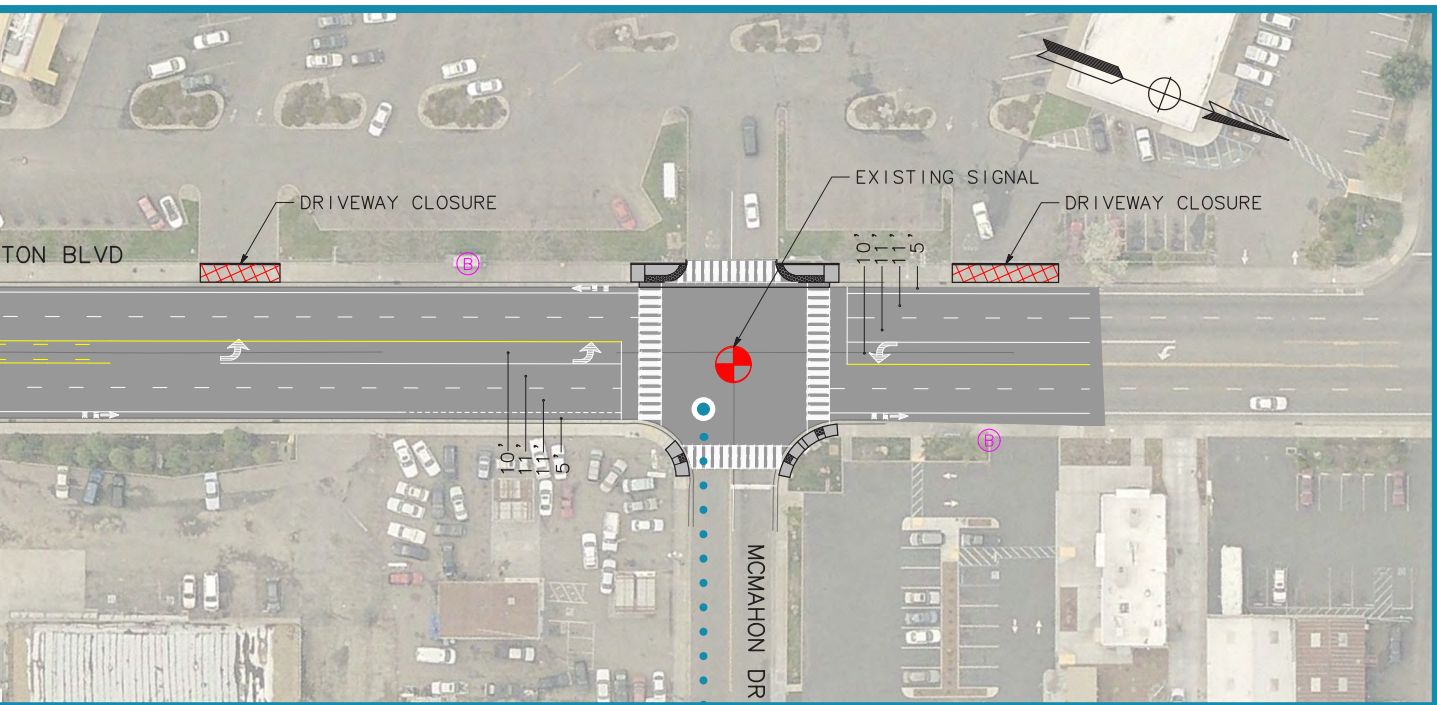

Consolidate Driveways



Bike Conflict Zone Markings



Raised Median



Advance Stop Bar



Stop Sign

How Will Travel Change?

Estimated Changes with Project

Average Vehicle Speed

Average vehicle speed along the corridor during peak periods is expected to decrease between 1 and 3 mph as a result of the proposed project. While slower travel speeds result in longer travel times, they reduce traffic fatalities and severe injuries that result from crashes.

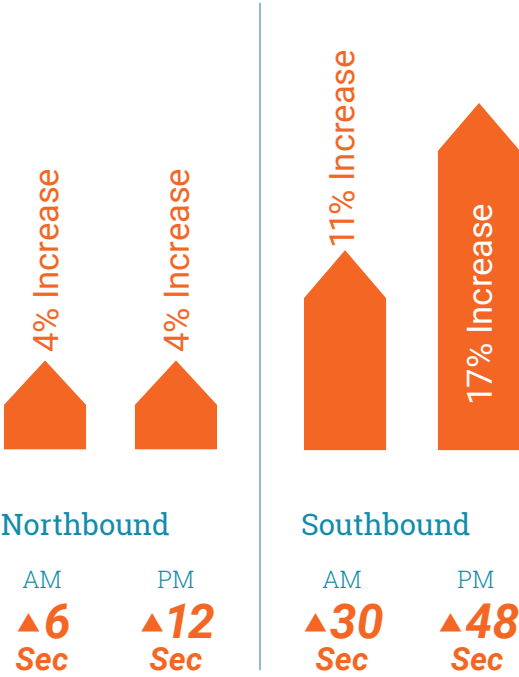
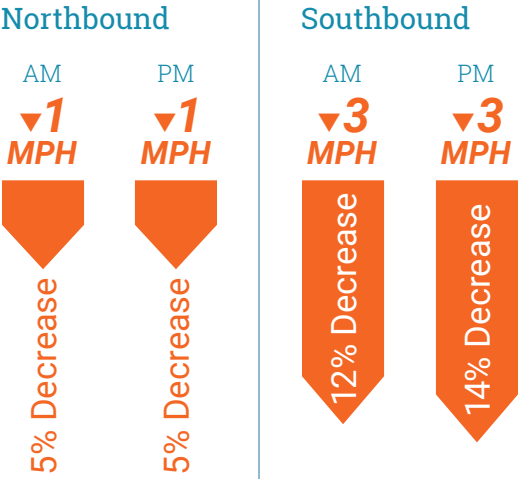

Vehicle Travel Time

Average vehicle travel time along the one-mile corridor during peak periods is expected to increase between 6 and 48 seconds as a result of the proposed project.

Estimated Changes with Project

Bike Lane Coverage

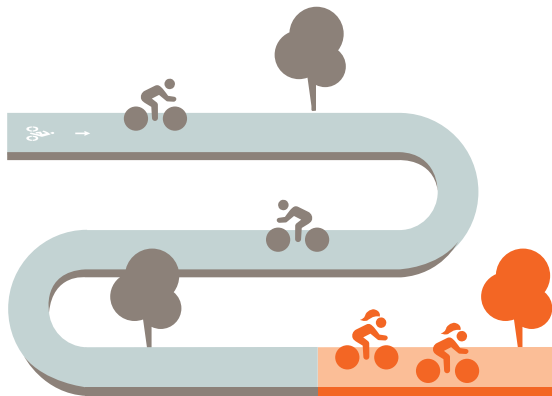

Without project
83%
(10,120 ft)

▶

With project
100%
(12,250 ft)

Share of Bike Lanes with Vertical Separation

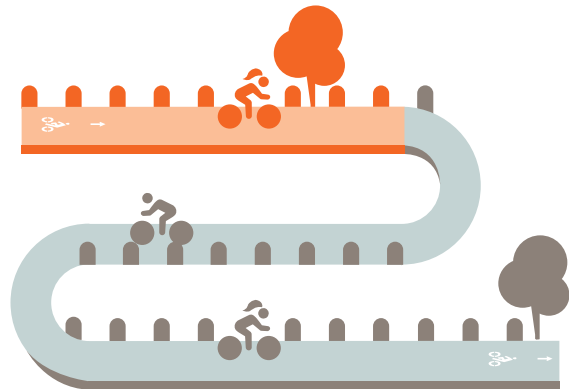

Without project
0%
(0 ft)

▶

With project
30%
(3,670 ft)

How Much Will the Project Cost?

Stockton Boulevard (South) Cost Summary

\$9,500,000

Construction

Construction costs include the cost to build the primary items associated with the safety countermeasures for the corridor. The items were estimated based on the preliminary design concepts and recent construction bid unit costs with an escalation factor to account for future construction. The costs were broken down into two categories that consisted of major roadway items and electrical items such as traffic signals and lighting. A contingency factor was included to account for refinement of project design, changes in project details, or unforeseen changes in construction costs.

Actual project costs will be determined by surveyed base mapping, geotechnical reports, concept refinement, environmental reviews, right of way availability, project phasing, and bid conditions at the time of advertisement. Project costs should be reviewed prior to any grant application or initiation of a Capital Improvement Project to revalidate and update the assumptions in this study as necessary.

Right of Way

In addition to construction costs, right of way costs were assumed that include temporary construction easements for items such driveway modifications, curb ramps reconstruction, signal equipment poles and cabinets. It was assumed that each project could be constructed almost exclusively within the roadway prism and right of way acquisition would not be needed along the entire project frontage. Further refinement of the base mapping in subsequent phases of design will more accurately identify specific right of way needs.

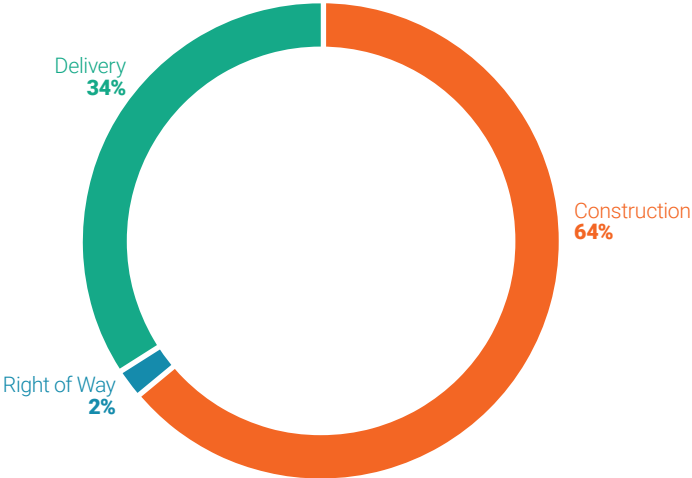

The total project costs shown in the summary chart have been escalated at an assumed 3% per year escalation factor to 2025, the anticipated year of construction.

Delivery

Project delivery costs are included in the estimates provided in this study. These costs encompass all of the work to complete subsequent phases including preliminary engineering, environmental documentation, final design, right of way engineering, and construction oversight. A breakdown of these costs is provided in Appendix C.



Florin Road at Luther Drive

Florin

Vision Zero
Top 5 Corridor

Florin Road

Vision Zero Top 5 Corridor

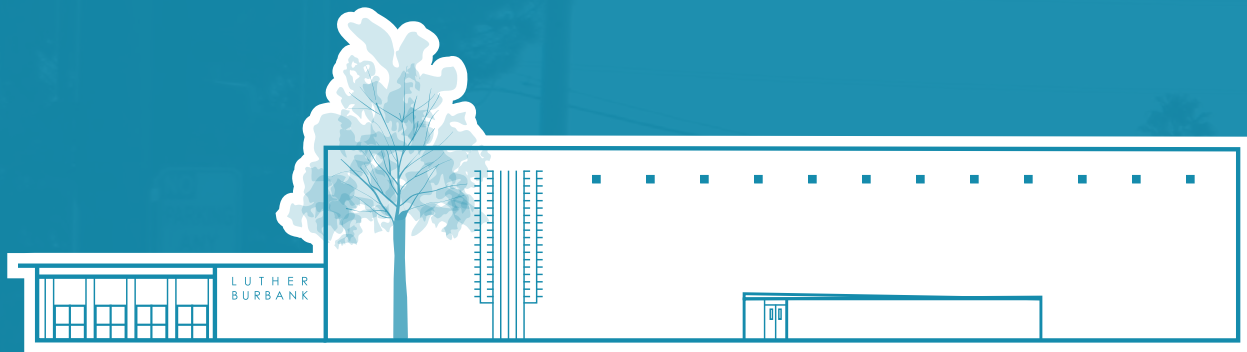

Florin Road - Luther Burbank High School

What is going on?

Between 2009 and 2017, 16 crashes that resulted in a fatality or severe injury (KSI) occurred on Florin Road between 24th Street and Munson Way. Eight of these crashes involved a person walking or biking.

What are the key issues?

Three-fourths of drivers who crashed were proceeding straight or stopped at the time of the crash, and nearly half of all crashes cited unsafe speed as the primary violation. Of the pedestrians who were hit, half were crossing the street in a marked crosswalk at the time. Nearly 40 percent of bike crashes involved a driver making a right-turn.

What is the community concerned about?

At outreach events, residents described difficulty crossing the street, particularly near the Florin Light Rail Station and Luther Burbank high school.

The following pages lay out the existing conditions along the corridor, feedback heard from residents at outreach events, and a set of roadway safety recommendations focused on slowing down drivers, increasing compliance with signals and signs, and improving safety for people walking and biking

Table of Contents

E-4

**In the
Neighborhood**

E-6

**Travel on
Florin**

E-8

**Safety on
Florin**

E-10

**Feedback from
the Community**

E-11

**Investments to
Enhance Safety**

E-12

**Conceptual Design
for Florin**

E-22

**How Will Travel
Change?**

E-24

**How Much Will
the Project Cost?**

In the Neighborhood

Corridor

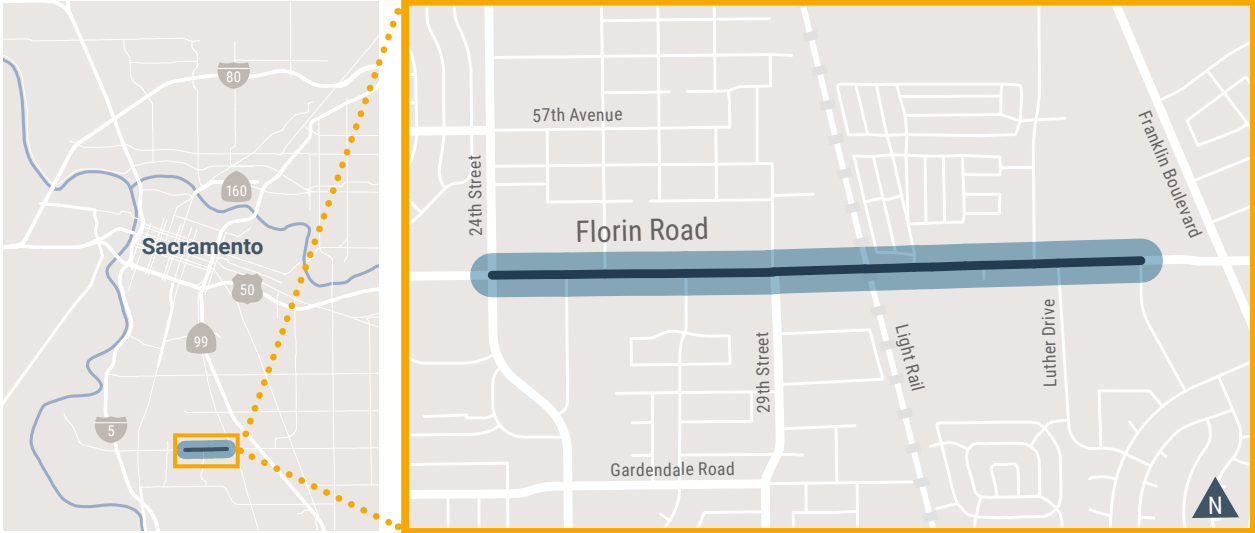

About the Neighborhood

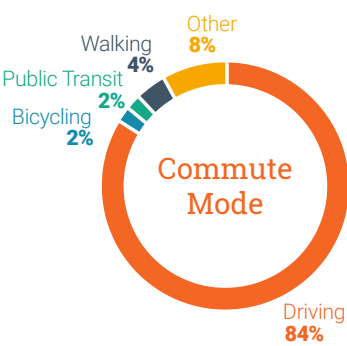

A larger share of residents in this neighborhood walk to work, when compared to the city as a whole.

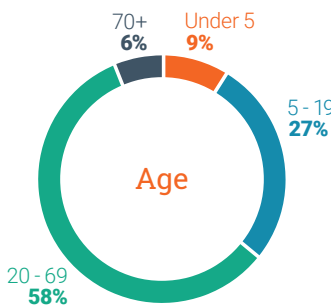

36% of residents in this neighborhood are age 19 or younger, compared with 26% of residents citywide.

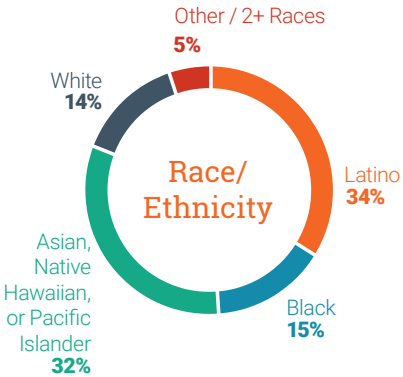

81% of residents in this neighborhood identify as Latino, Black or Asian, compared with 61% of residents citywide.



Florin Road east of Luther Drive



Florin Road at light rail crossing

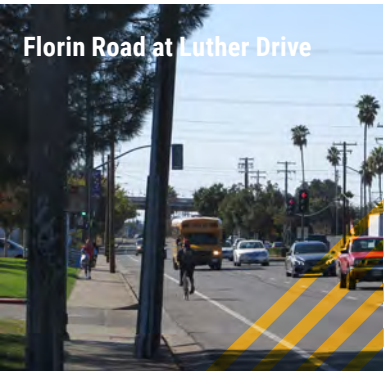

Florin Road at Luther Drive

Key Destinations Along the Corridor

Parks

1 

Schools & Libraries

2 

Food Markets

1 

Houses of Worship

3 

Light Rail Stations

1 

Travel on Florin

Key Statistics

Posted Speed Limit

40
MPH

Daily Vehicles

36,000

Maximum PM Intersection Vehicle Volume

2,540

PM Rush Hour People Walking

163

PM Rush Hour People Biking

119

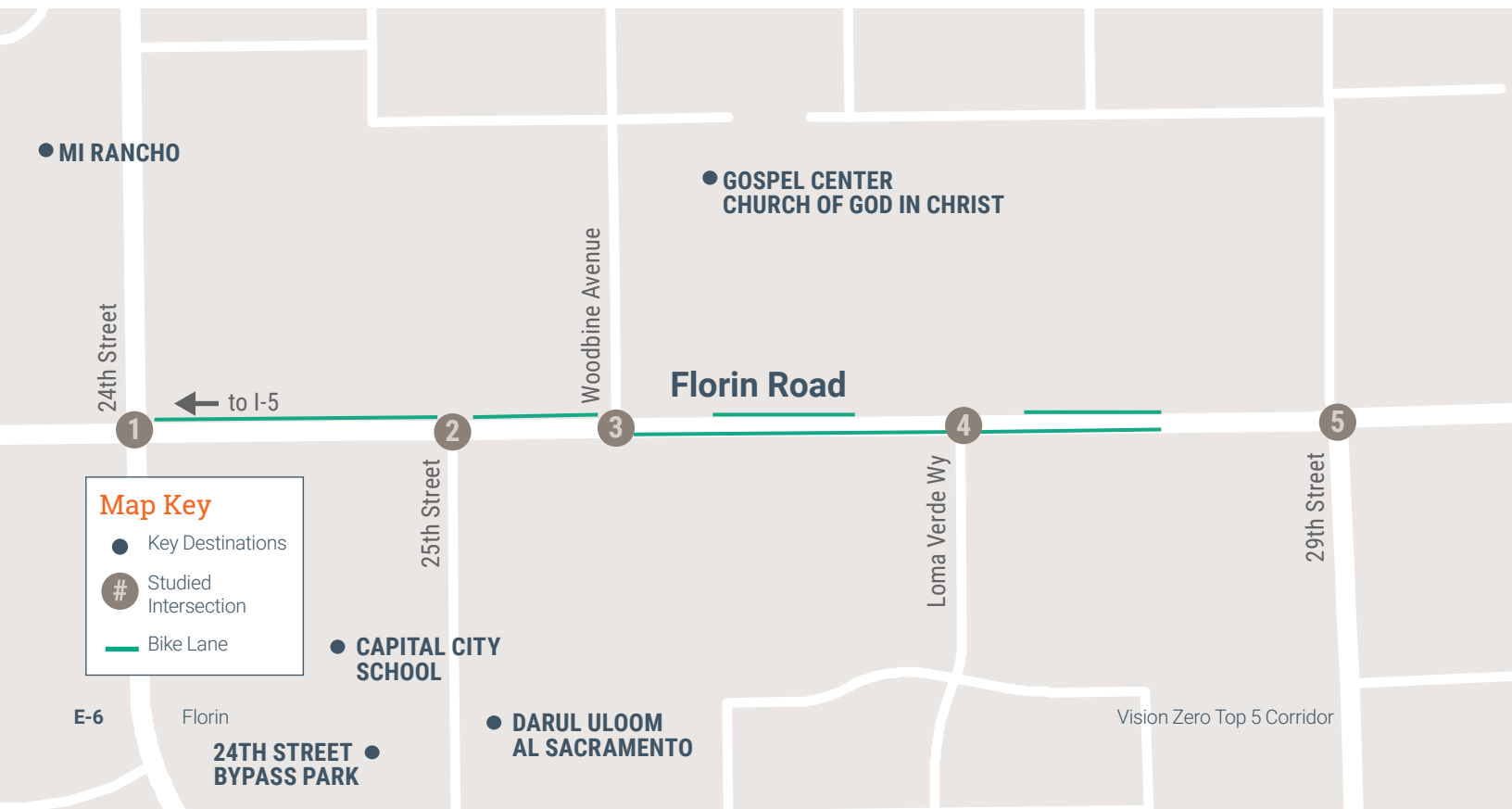
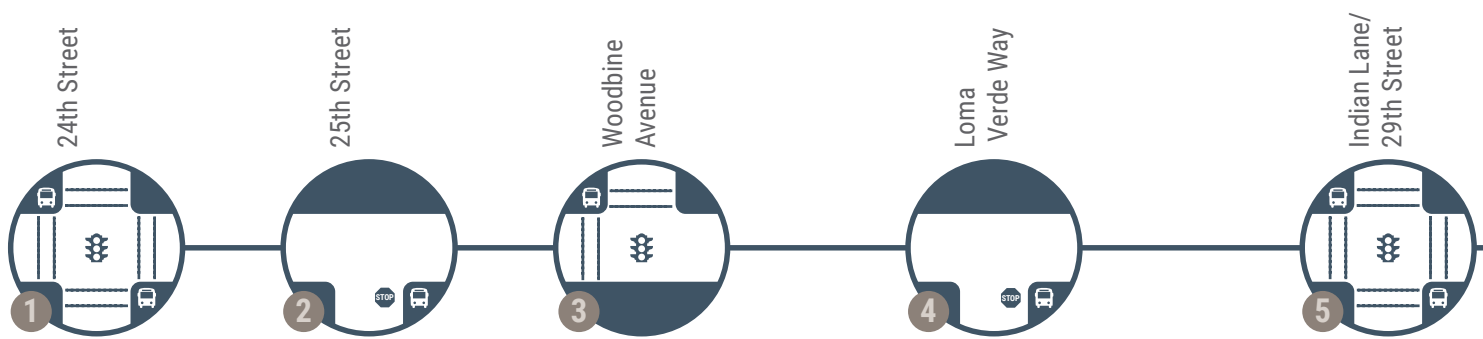

Number of
Transit Routes

3
#54, #81,
Blue Line

Bikeway
Type

**On-Street
Bike Lanes,
with long
gaps**

Longest Distance
Between Marked
Crosswalks

1,740
Ft

Sidewalk
Coverage

100%

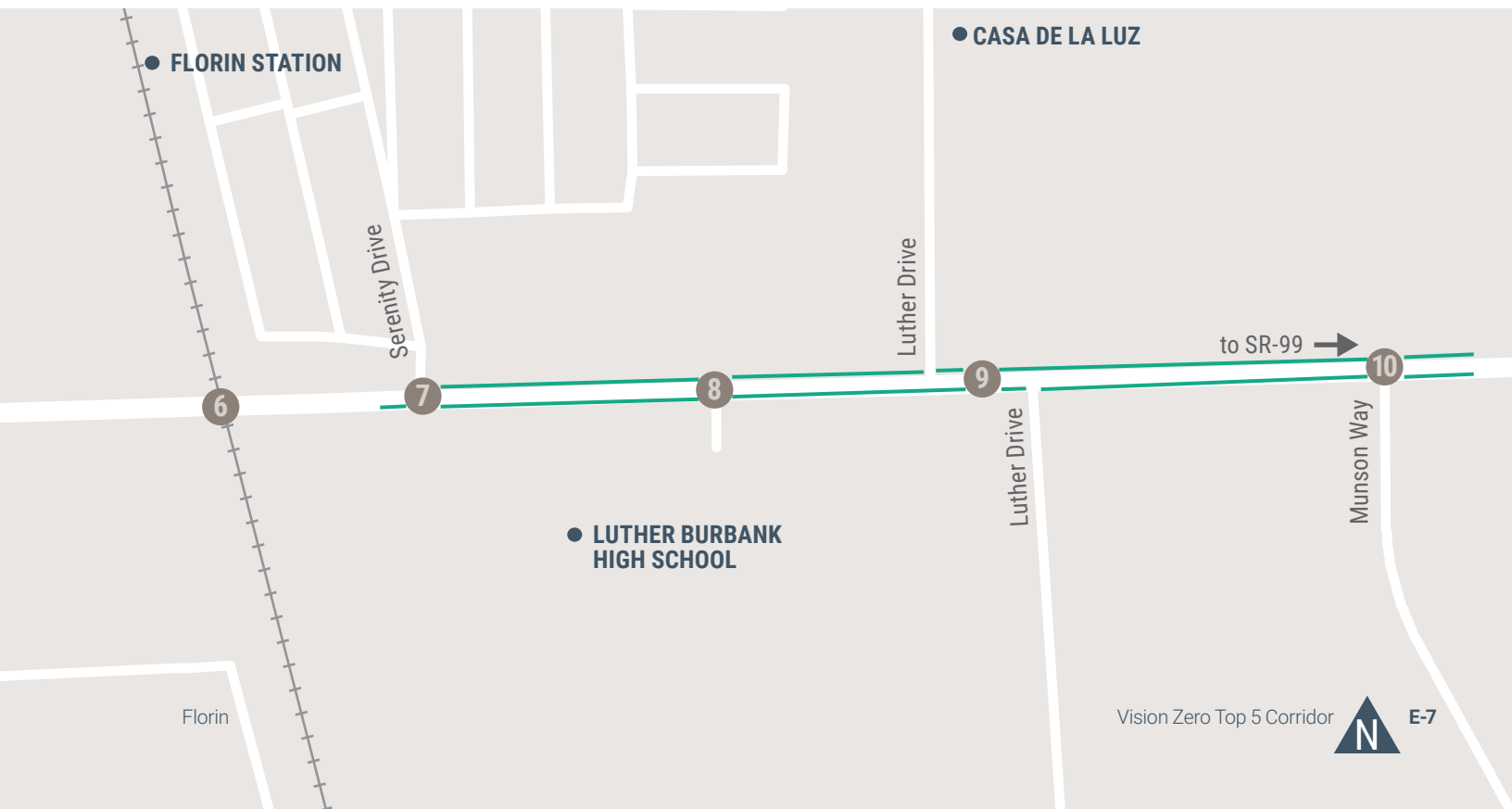
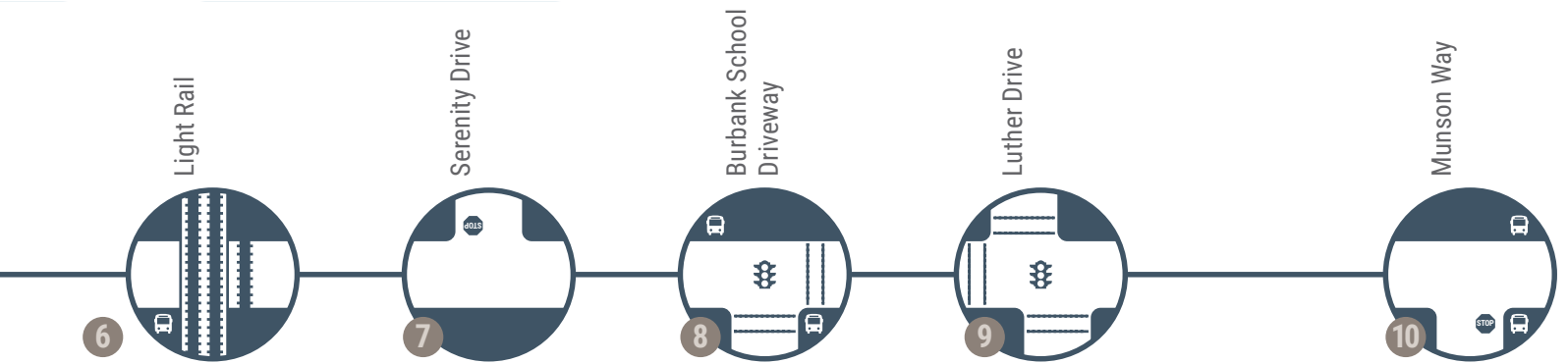

Crashes on Florin

Vehicle Crash Types

Unsafe Speed

“Unsafe Speed” was cited as the primary violation in nearly half of all crashes.

1 2 3 4 5 6
7 8 9 10

Proceeding Straight

75% of drivers were proceeding straight or stopped at the time of the crash.

1 2 3 4 5 6
7 8 9 10

Rear End

Nearly half of all crashes were rear end.

1 2 3 4 5 6
7 8 9 10

Crash Locations

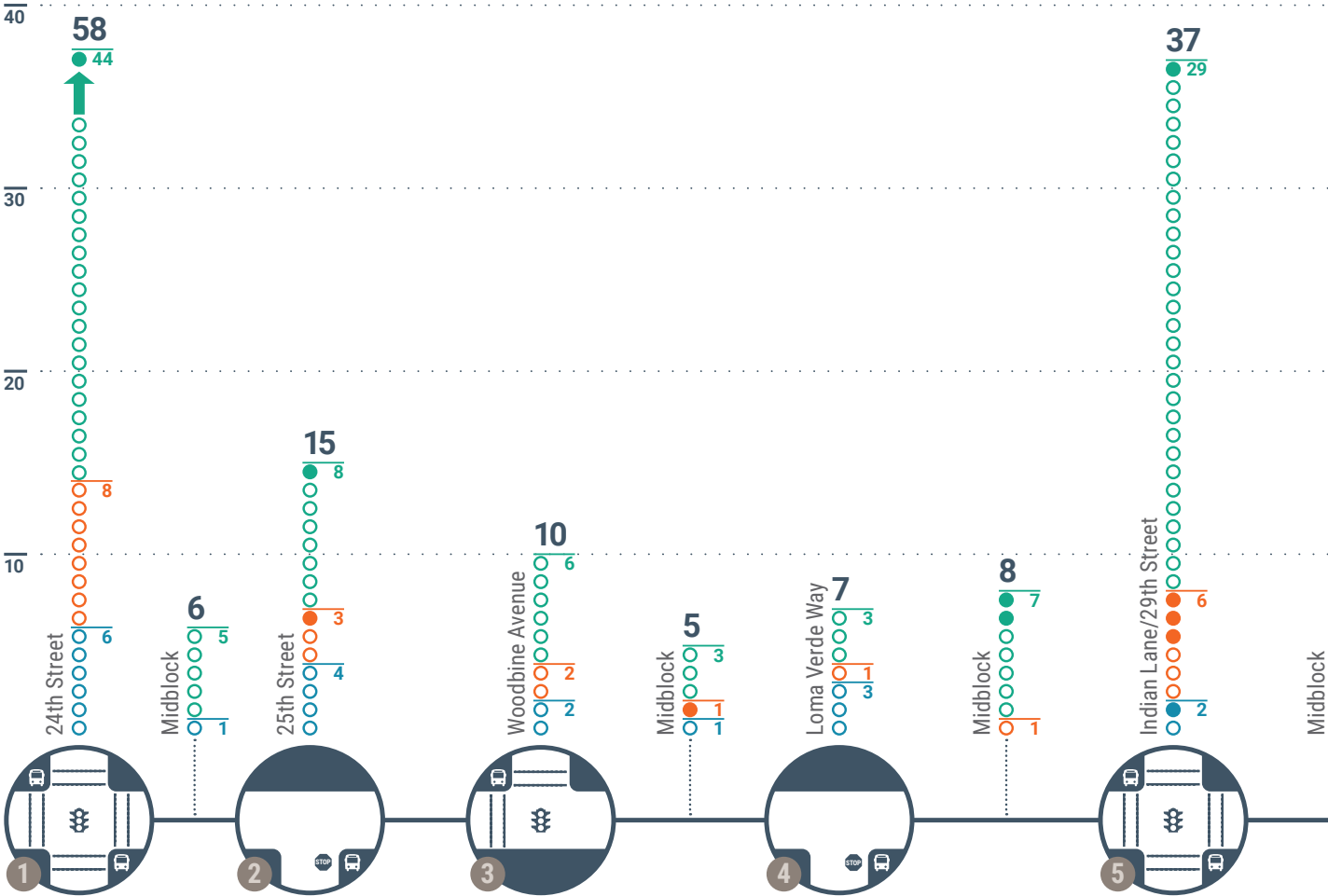

Ped Crash Types

Bike Crash Types



Pedestrian Crossing

The majority of people hit while walking were crossing. Half of people were in the crosswalk.

1 2 3 4 5 6
7 8 9 10



Right Turns

In nearly 40% of bike crashes, the driver was making a right turn.

1 2 3 4 5 6
7 8 9 10



Broadside

More than half of bike crashes were broadside, also called T-Bone.

1 2 3 4 5 6
7 8 9 10

1 Numbers that are turned on represent a location where crash type has occurred at least three times.

Total Crashes	
Vehicle	192
Pedestrian	28
Bike	29
All Injury Crashes	192
Fatal and Severe Crashes	14

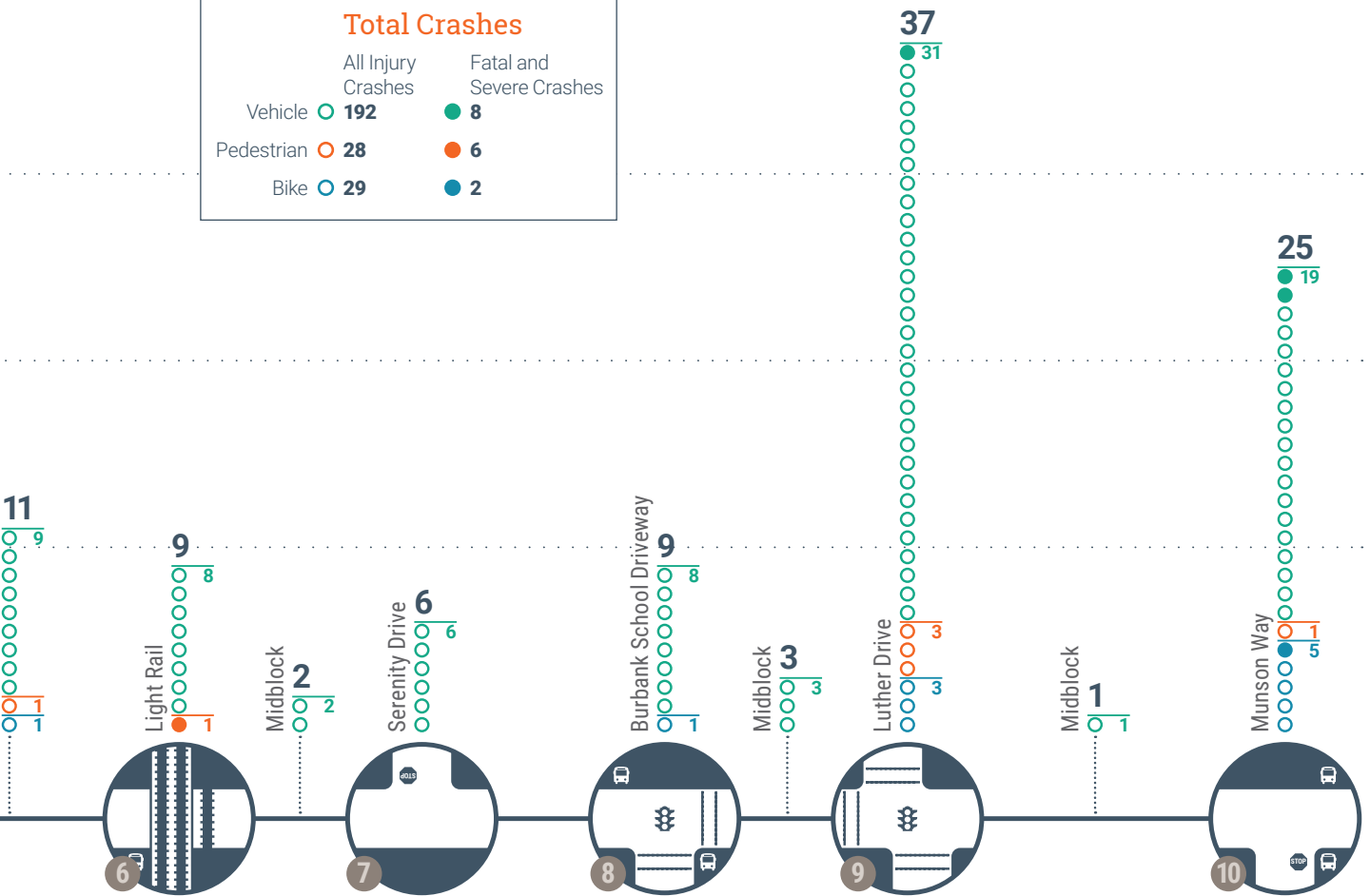

Feedback from the Community

“We need to slow drivers down.”

“The signals need more time for crossing (when seniors cross it is too short).”



Luther Burbank High School Community Workshop

Key Themes

Traffic Enforcement

Residents described speeding, and red light and stop sign running across the corridor and suggested increased speed enforcement could deter this behavior.

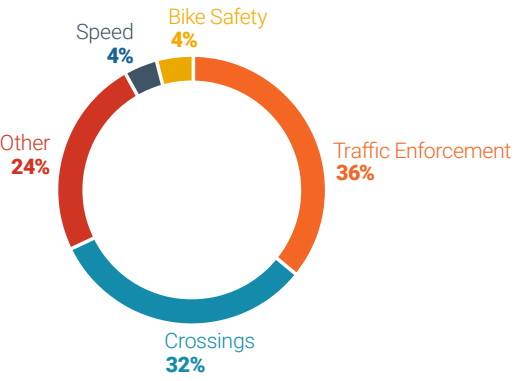

Crossings







Residents described difficulty crossing the street, particularly by the Florin light rail station and Luther Burbank High School, due to large spacing between marked crosswalks.

Engagement Events

- November 15, 2018
Luther Burbank High School Community Workshop
- May 5, 2019
Luther Burbank High School Community Open House

Investments to Enhance Safety

Key Crash Countermeasures

Countermeasure	Crash Type	Feedback Key Theme
 <p>Slow Green Wave</p> <p>TO ADDRESS</p>	 <p>Unsafe Speed</p>	Enforcement & Compliance
 <p>Add New Signal</p> <p>TO ADDRESS</p>	 <p>Pedestrian Crossing</p>	Crossings
 <p>Advanced Dilemma-Zone Detection</p> <p>TO ADDRESS</p>	 <p>Rear End</p>	Enforcement & Compliance

How Will The Roadway Space Be Used?

Section E Existing



Section E Proposed

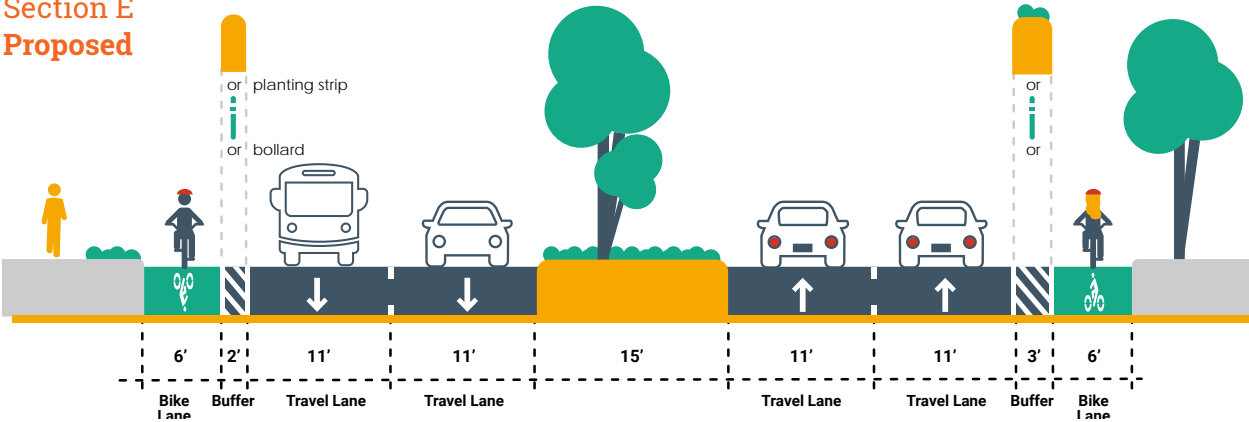

Conceptual Design for Florin



Bike Conflict Zone Markings

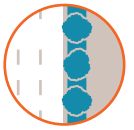

Landscape Buffer

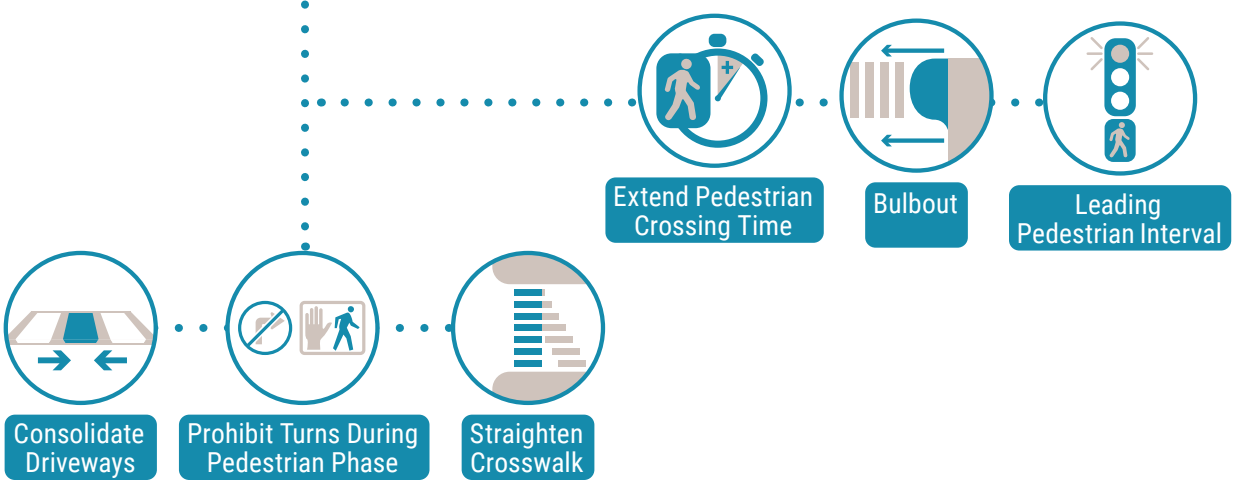
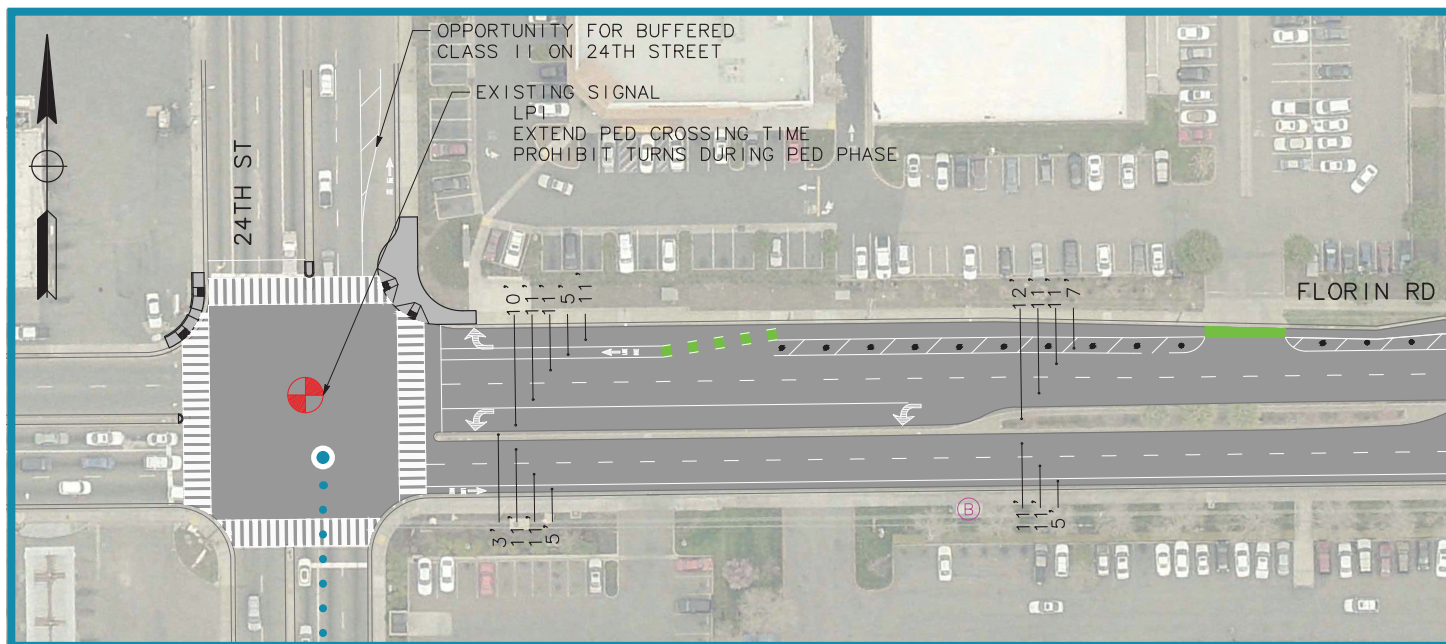

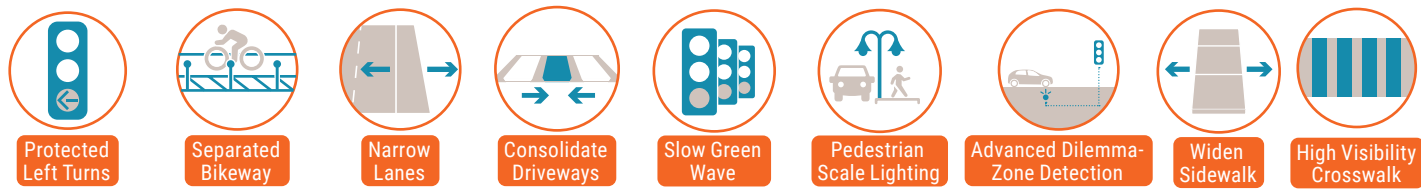

Corridor-Wide Recommendations

Location-Specific Recommendations

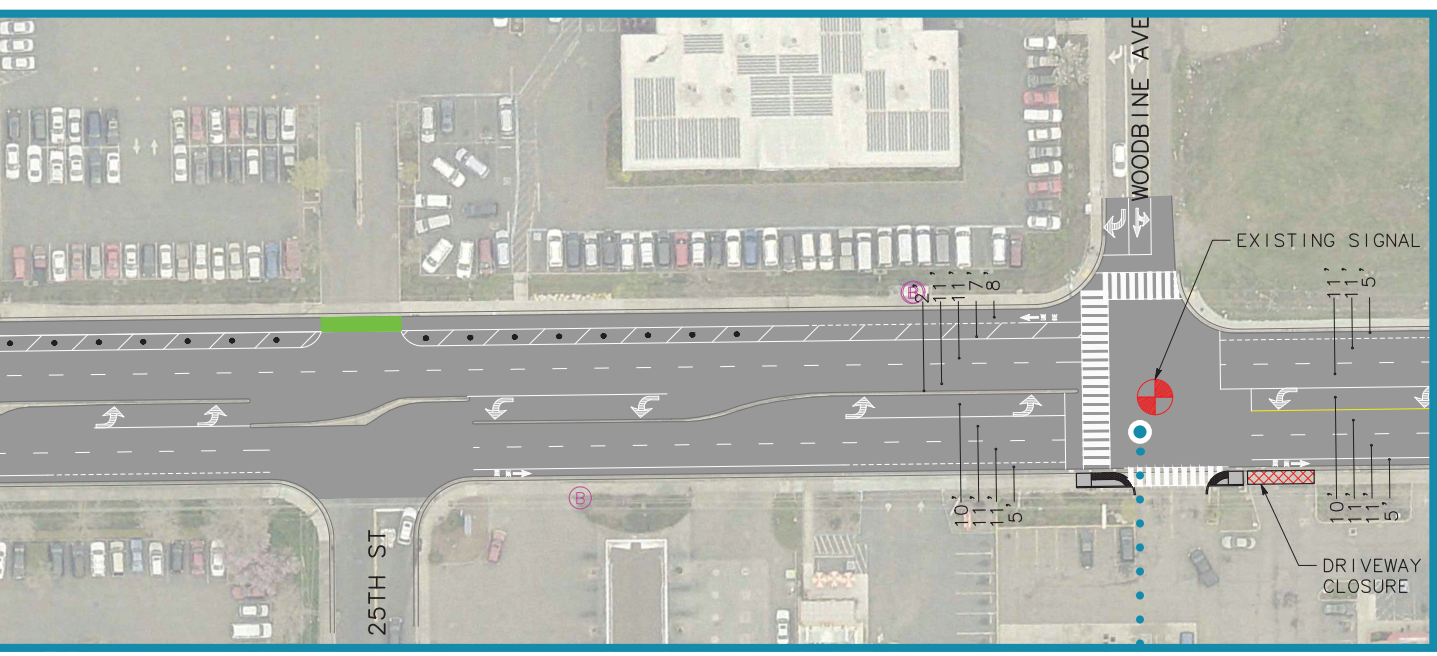

Conceptual Design for Florin



Bike Conflict Zone Markings

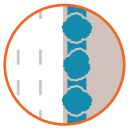

Landscape Buffer

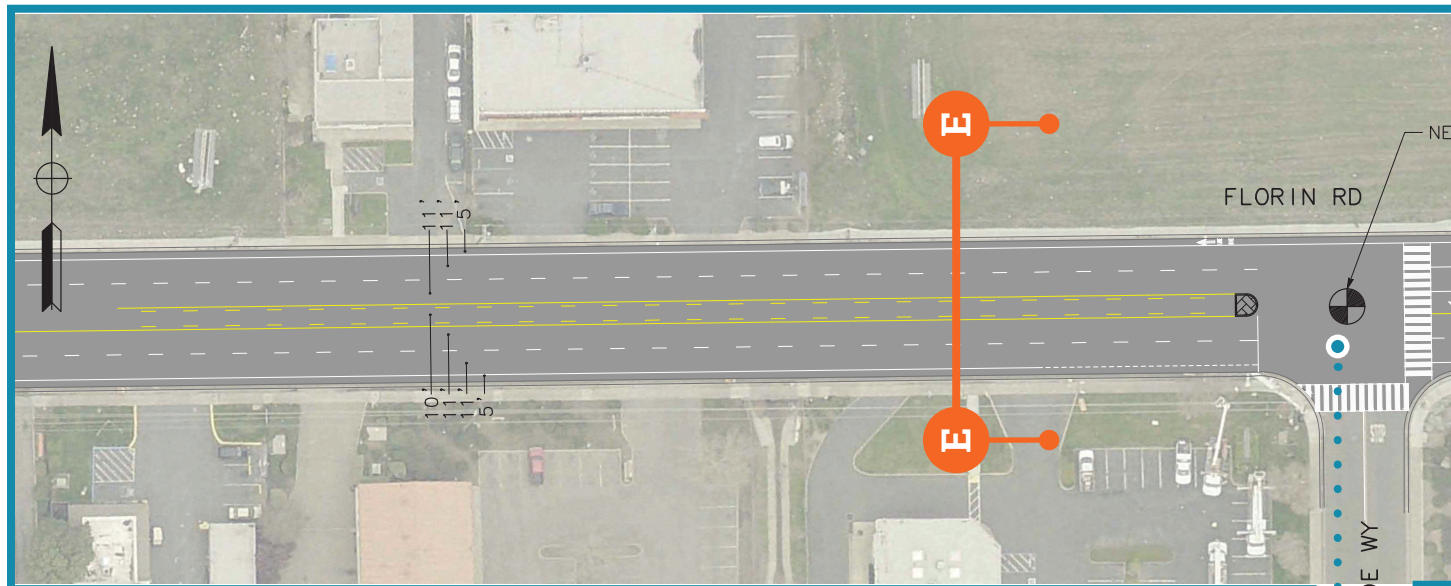

SEE PAGE E-159



Close Bike Lane Gap



New Traffic Signal

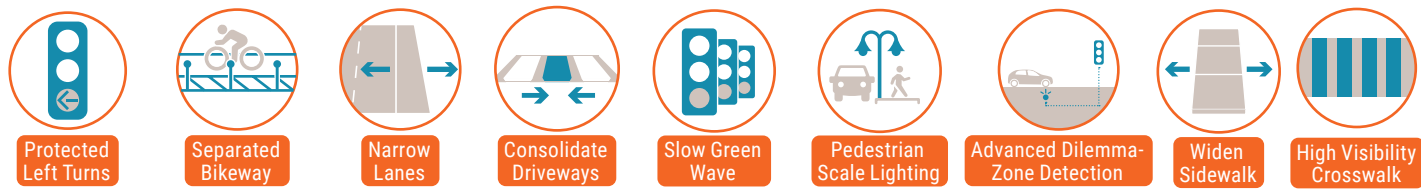

Corridor-Wide Recommendations

Location-Specific Recommendations

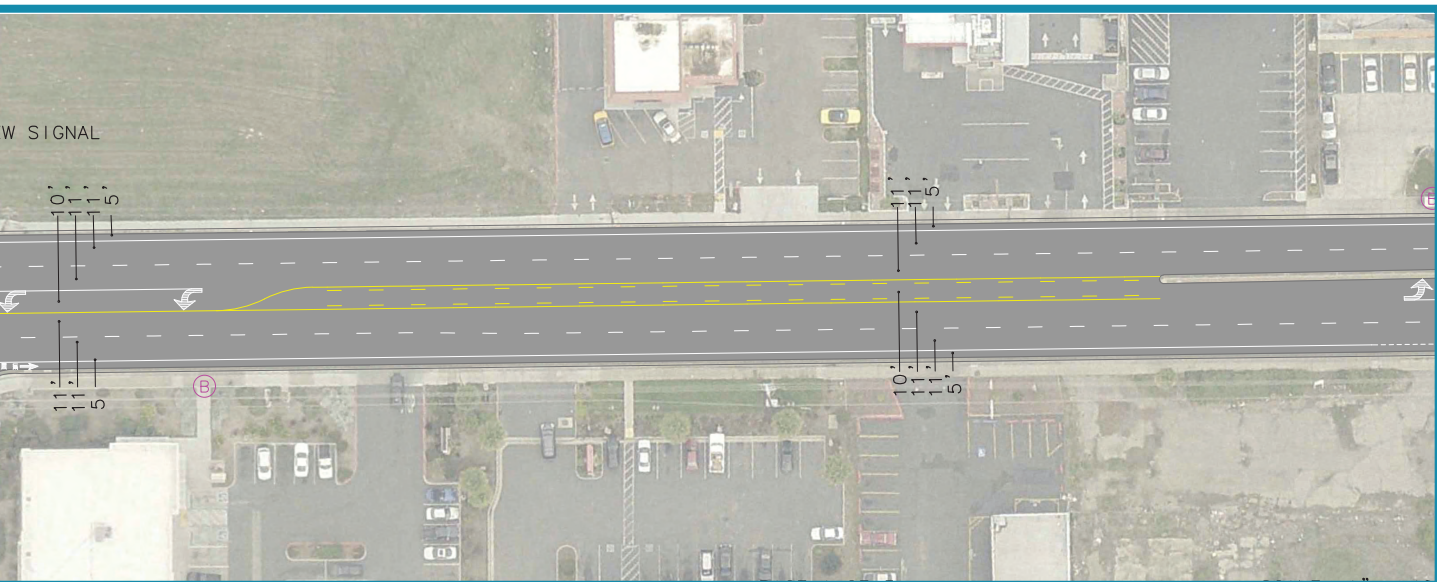

Conceptual Design for Florin



Bike Conflict Zone Markings

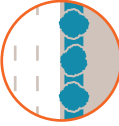

Landscape Buffer

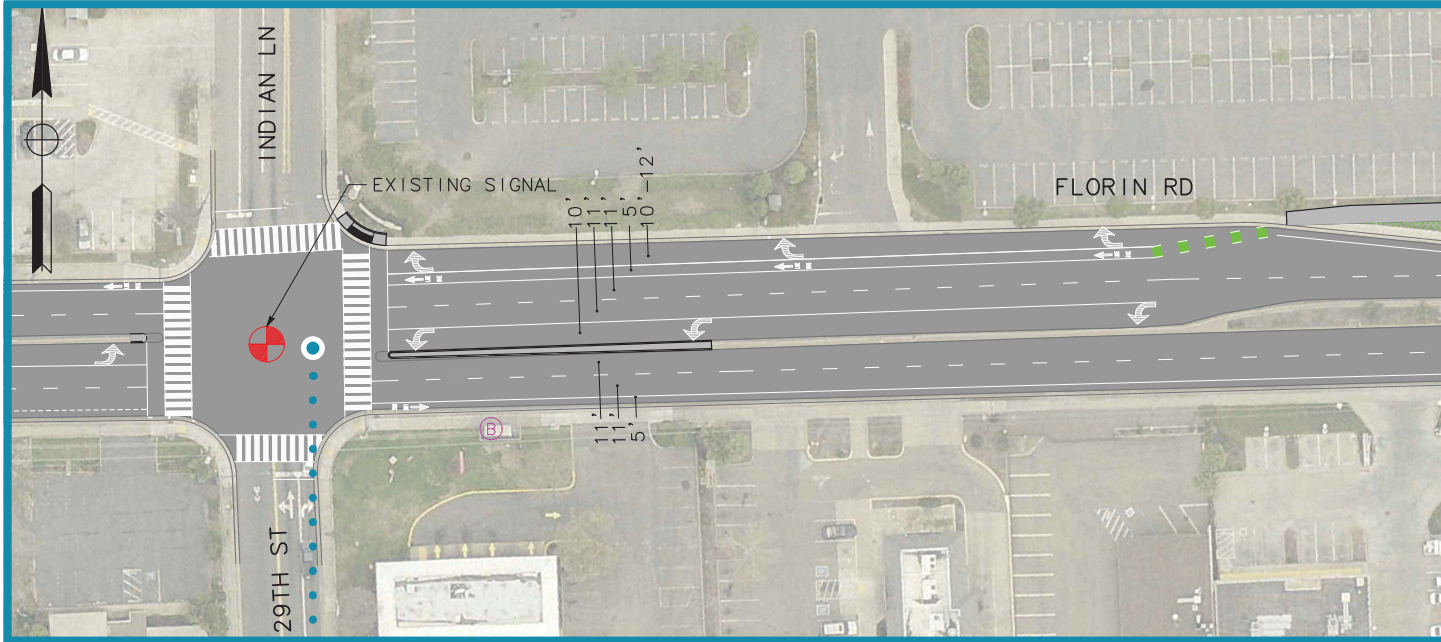

Dual Curb Ramps

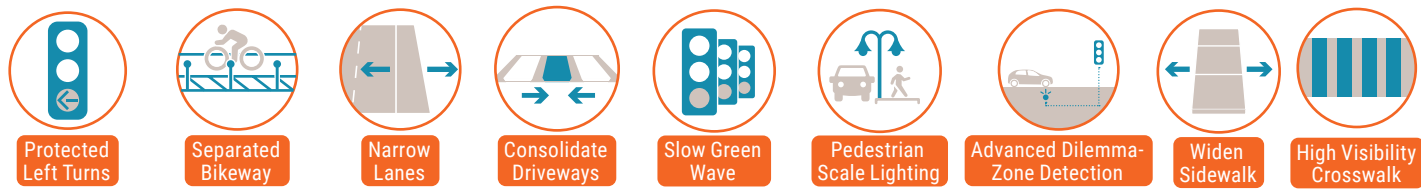

Corridor-Wide Recommendations

Location-Specific Recommendations

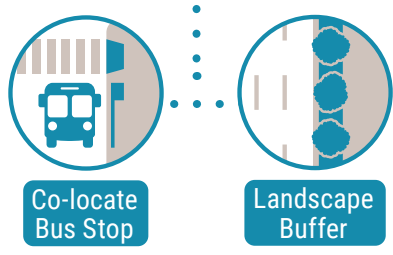
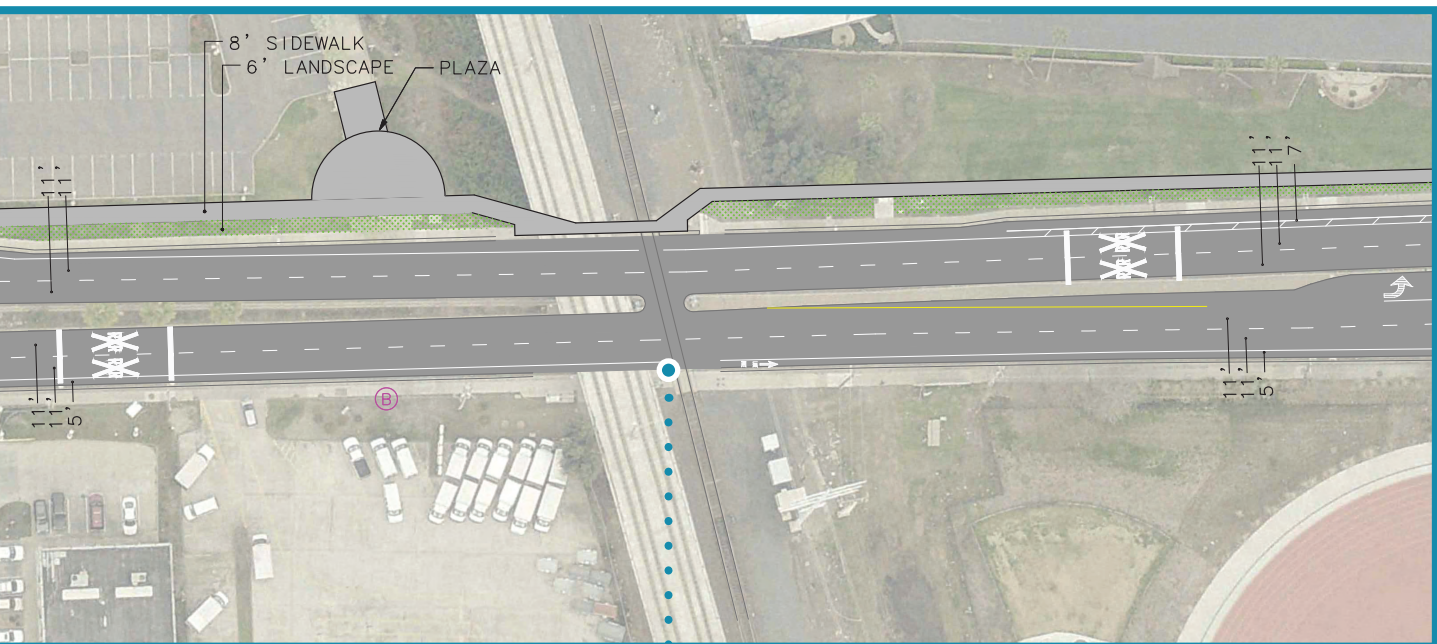

Conceptual Design for Florin



Bike Conflict Zone Markings

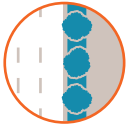

Landscape Buffer

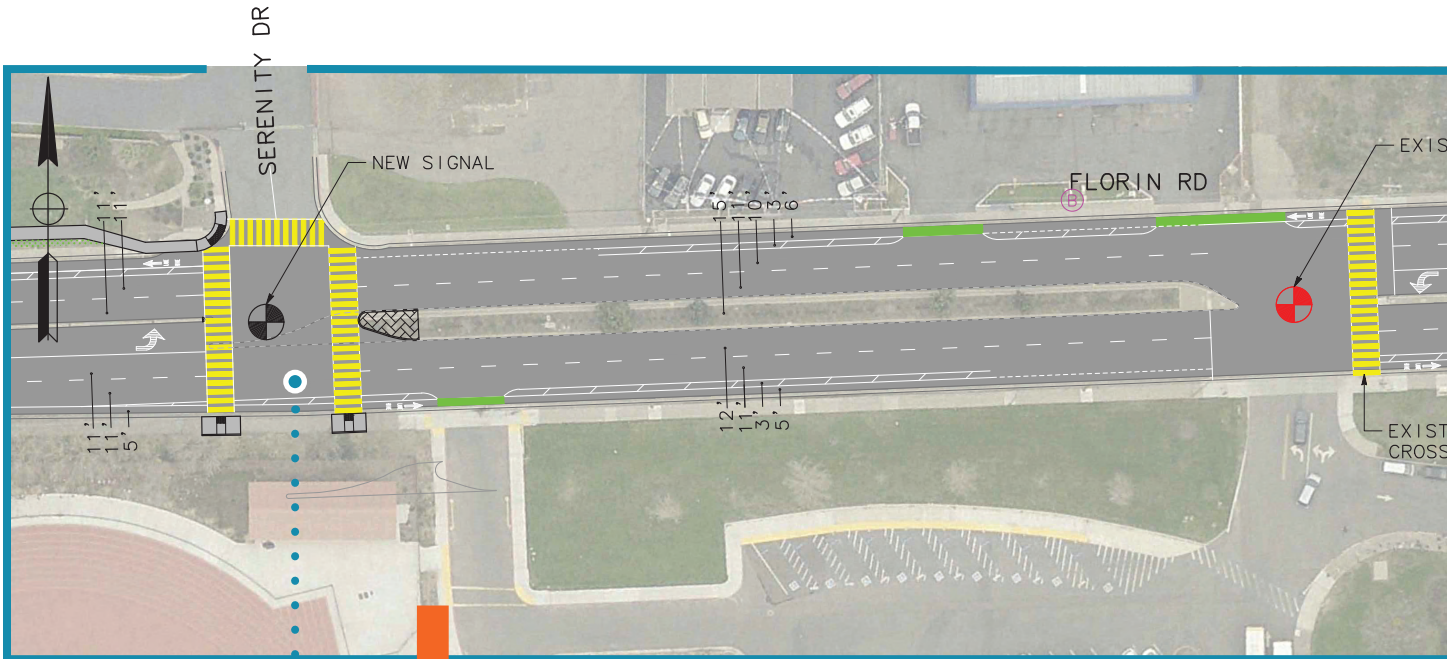

New Traffic Signal

Florin Road/Serenity Drive Queues

The Florin Road/Serenity Drive intersection is approximately 450-foot east of railroad tracks operated by Union Pacific Railroad. If a signal is installed at Florin Road/Serenity Drive, measures should be taken to ensure the eastbound queue does not spill back onto the railroad.

Queues were calculated from SimTraffic models representing existing conditions with the Vision Zero recommendations implemented. The peak hour maximum queues of this new signal are shown in Appendix B.

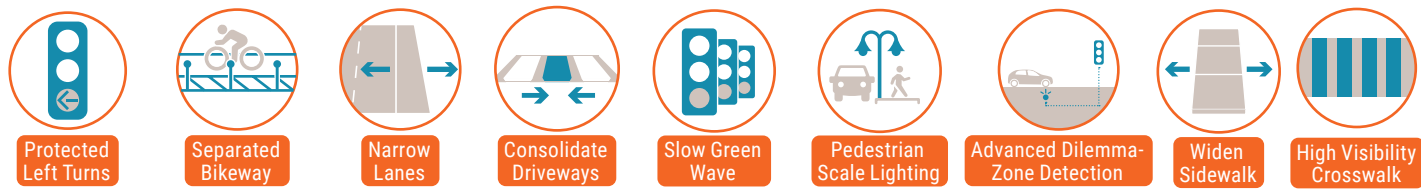

Corridor-Wide Recommendations

Location-Specific Recommendations

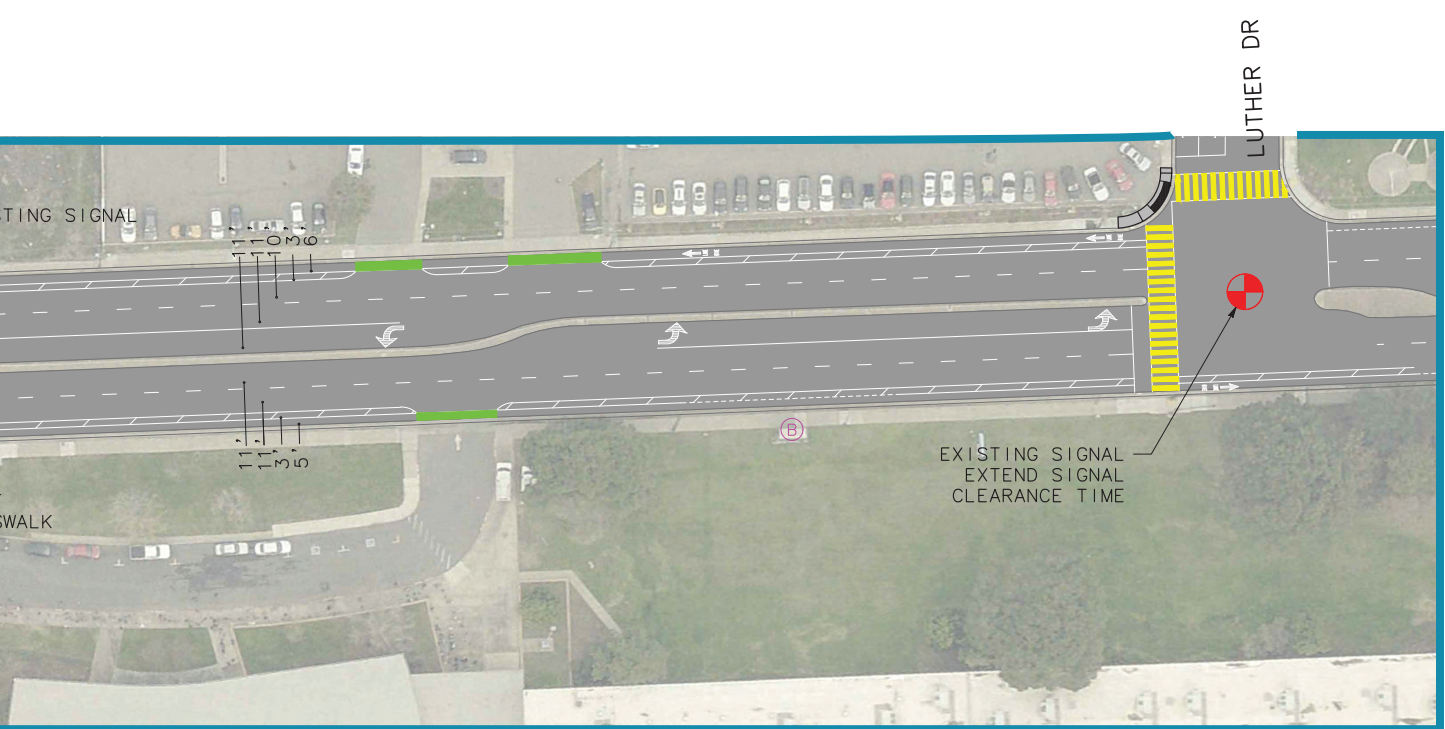

Conceptual Design for Florin



Bike Conflict Zone Markings

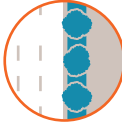

Landscape Buffer



Extend Signal Clearance Time

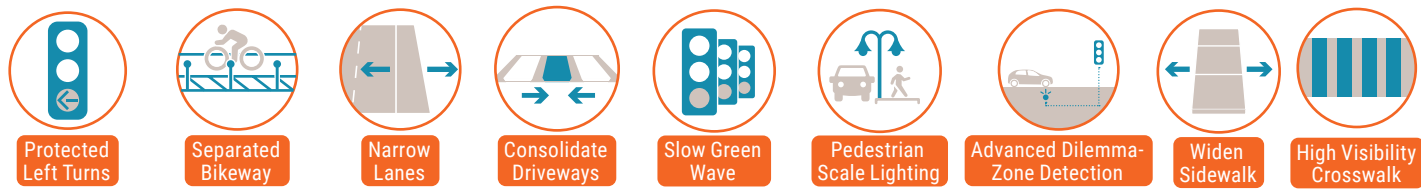

Corridor-Wide Recommendations

Location-Specific Recommendations

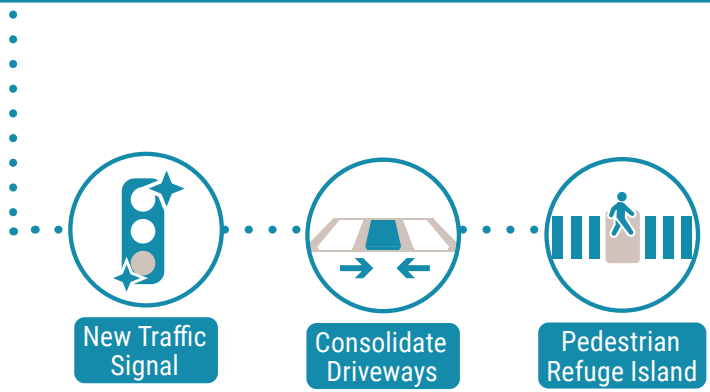
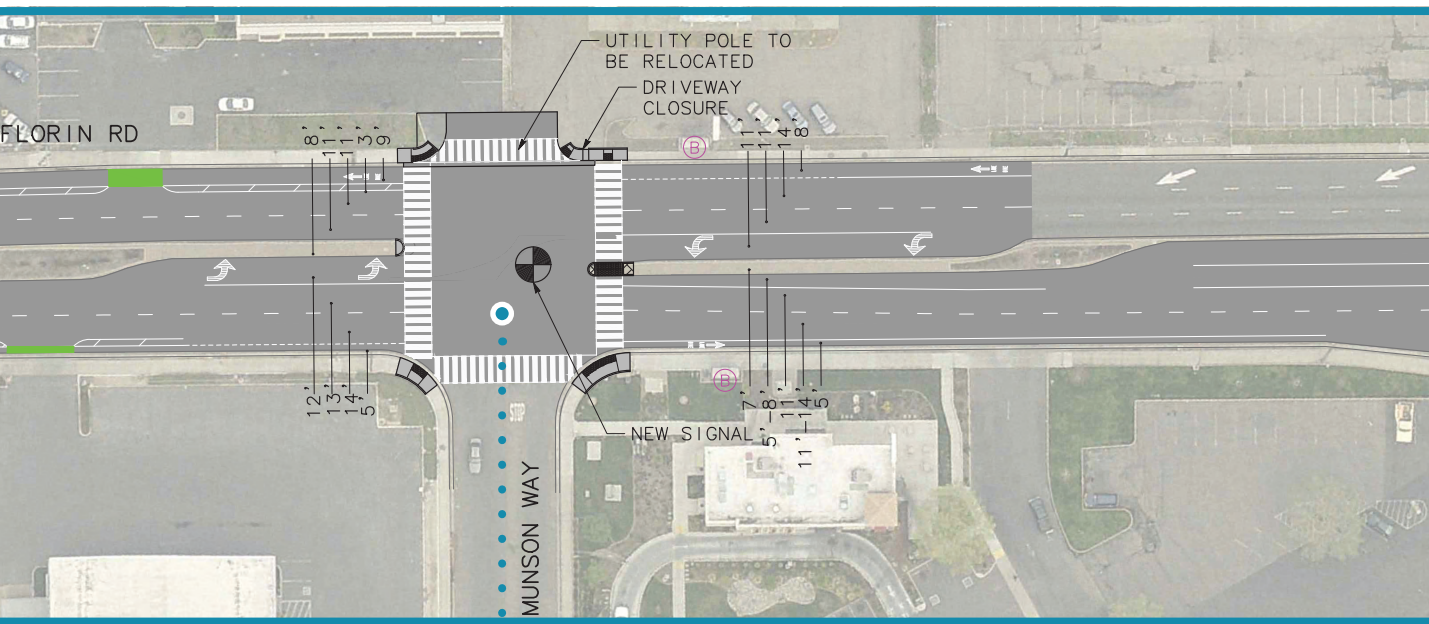

How Will Travel Change?

Estimated Changes with Project

Average Vehicle Speed

Average vehicle speed along the corridor during peak periods is expected to decrease between 1 and 3 mph as a result of the proposed project. While slower travel speeds result in longer travel times, they reduce traffic fatalities and severe injuries that result from crashes.

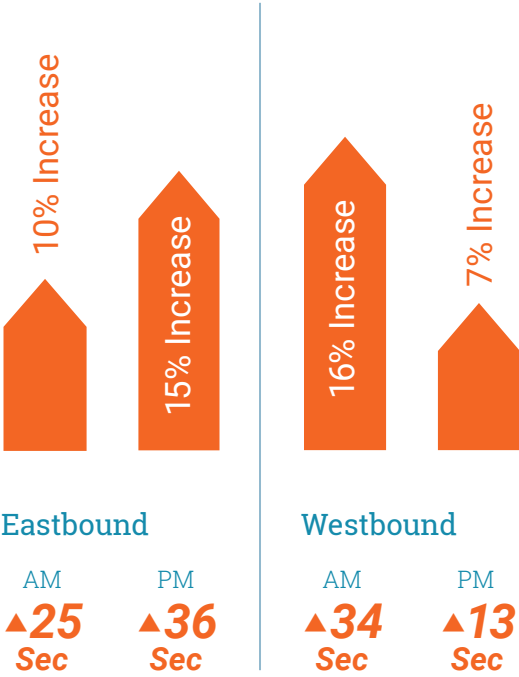
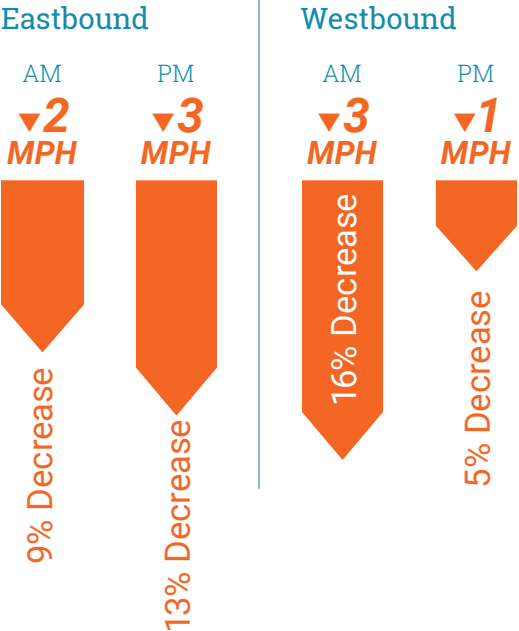

Vehicle Travel Time

Average vehicle travel time along the one-mile corridor during peak periods is expected to increase between 13 and 36 seconds as a result of the proposed project.

Estimated Changes with Project

Bike Lane Coverage

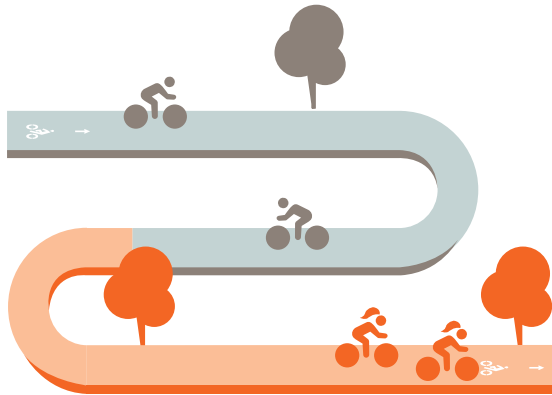

Without project
56%
(7,190 ft) ▶ **100%**
(12,780 ft)

Share of Bike Lanes with Vertical Separation

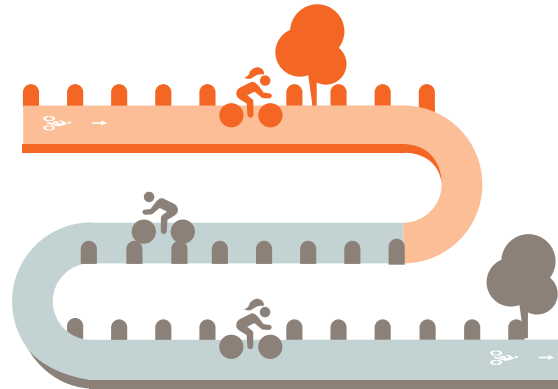

Without project
0%
(0 ft) ▶ **38%**
(4,900 ft)

Number of Locations Upgraded to Controlled Crossings

3

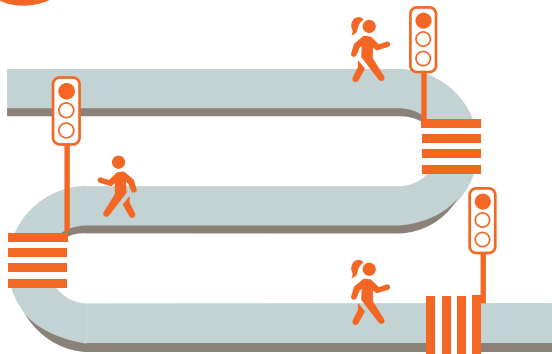

Number of Marked Crosswalks

10 new crossings

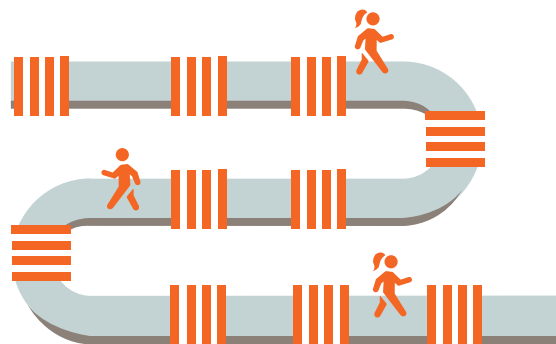

How Much Will the Project Cost?

Florin Road Cost Summary

\$11,900,000

Construction

Construction costs include the cost to build the primary items associated with the safety countermeasures for the corridor. The items were estimated based on the preliminary design concepts and recent construction bid unit costs with an escalation factor to account for future construction. The costs were broken down into two categories that consisted of major roadway items and electrical items such as traffic signals and lighting. A contingency factor was included to account for refinement of project design, changes in project details, or unforeseen changes in construction costs.

Actual project costs will be determined by surveyed base mapping, geotechnical reports, concept refinement, environmental reviews, right of way availability, project phasing, and bid conditions at the time of advertisement. Project costs should be reviewed prior to any grant application or initiation of a Capital Improvement Project to revalidate and update the assumptions in this study as necessary.

Right of Way

In addition to construction costs, right of way costs were assumed that include temporary construction easements for items such driveway modifications, curb ramps reconstruction, signal equipment poles and cabinets. It was assumed that each project could be constructed almost exclusively within the roadway prism and right of way acquisition would not be needed along the entire project frontage. Further refinement of the base mapping in subsequent phases of design will more accurately identify specific right of way needs.

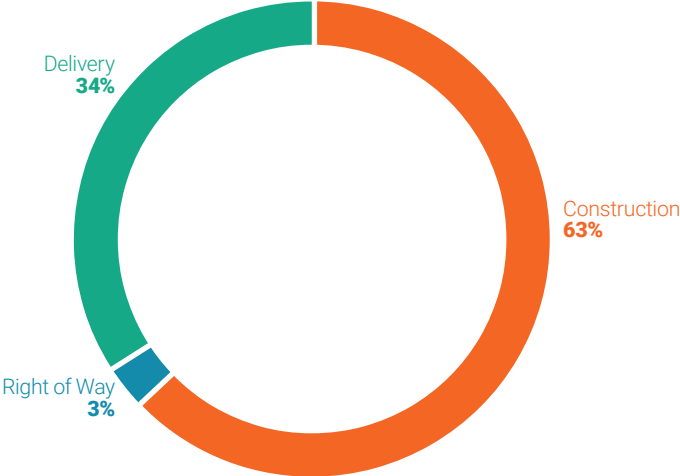

The total project costs shown in the summary chart have been escalated at an assumed 3% per year escalation factor to 2025, the anticipated year of construction.

Delivery

Project delivery costs are included in the estimates provided in this study. These costs encompass all of the work to complete subsequent phases including preliminary engineering, environmental documentation, final design, right of way engineering, and construction oversight. A breakdown of these costs is provided in Appendix C.



TOP 5 CORRIDORS

Vision
ZERO

Appendix A

Related Documents



Vision Zero Top 5 Corridors Existing Conditions Report

**Prepared for:
City of Sacramento**

March 2019

RS18-3649

FEHR & PEERS

Table of Contents

Introduction	1
Relationship to Vision Zero Action Plan	1
Identification of Segments	1
Methodology	10
Traffic Operations Analysis.....	10
StreetScore+ Analysis	11
Collision Analysis	12
Crash Database	12
Serious Injury Crashes	12
Roadway and Contextual Data	13
Crash Types	13
Public Outreach	14
Broadway/Stockton Boulevard (North)	15
Existing Conditions	15
Vehicular Facilities	20
Transit Facilities	21
Pedestrian Facilities	22
Bicycle Facilities	24
StreetScore+	24
Collision Analysis	26
Broadway	26
Stockton Boulevard	27
Feedback	27
El Camino Avenue	32
Existing Conditions	32
Vehicular Facilities	32
Transit Facilities	36
Pedestrian Facilities	36
Bicycle Facilities	37
StreetScore+	39
Collision Analysis	40
Feedback	43
Florin Road	44
Existing Conditions	44
Vehicular Facilities	44

Transit Facilities	47
Pedestrian Facilities	48
Bicycle Facilities	48
StreetScore+	49
Collision Analysis	50
Feedback	50
Marysville Boulevard	53
Existing Conditions	53
Vehicular Facilities	53
Transit Facilities	57
Pedestrian Facilities	58
Bicycle Facilities	58
StreetScore+	59
Collision Analysis	60
Feedback	63
Stockton Boulevard (South)	64
Existing Conditions	64
Vehicular Facilities	64
Transit Facilities	68
Pedestrian Facilities	68
Bicycle Facilities	68
StreetScore+	68
Collision Analysis	69
Feedback	72

List of Figures

- Figure 1: Map of Top 5 Corridors within City of Sacramento 3
- Figure 2: Average Daily Traffic of Top 5 Corridors 4
- Figure 3: Total Crashes by Year 5
- Figure 4: Total Crashes by Mode 6
- Figure 5: Total Crashes by Severity 8
- Figure 6: KSI Crashes by Mode 9
- Figure 7: Broadway Travel Patterns 16
- Figure 8: Stockton Boulevard (North) Travel Patterns 17
- Figure 9: Broadway Existing Conditions 18
- Figure 10: Stockton Boulevard (North) Existing Conditions 19
- Figure 11: Stockton Boulevard 23
- Figure 12: Stockton Boulevard/Broadway Intersection 24
- Figure 13: Stockton Boulevard 27
- Figure 14: Broadway Crashes 28
- Figure 15: Broadway Crash Types 29
- Figure 16: Stockton Boulevard (North) Crashes 30
- Figure 17: Stockton Boulevard (North) Crash Types 31
- Figure 18: El Camino Avenue Travel Patterns 33
- Figure 19: El Camino Avenue Existing Conditions 34
- Figure 20: Del Paso Boulevard/Beaumont Street/El Camino Avenue Intersection 36
- Figure 21: Bike Lanes on El Camino Avenue 38
- Figure 22: El Camino Avenue/Altos Avenue Intersection 39
- Figure 23: El Camino Avenue Crashes 41
- Figure 24: El Camino Avenue Crash Types 42
- Figure 25: Florin Road Travel Patterns 45
- Figure 26: Florin Road Existing Conditions 46
- Figure 27: Florin Road and Light Rail Overcrossing 47
- Figure 28: Florin Road 48
- Figure 29: Florin Road Crashes 51
- Figure 30: Florin Road Crash Types 52
- Figure 31: Marysville Boulevard Travel Patterns 54
- Figure 32: Marysville Boulevard Existing Conditions 55
- Figure 33: Marysville Boulevard 56
- Figure 34: Marysville Boulevard/Roanoke Avenue HAWK 58
- Figure 35: Marysville Boulevard Crashes 61
- Figure 36: Marysville Boulevard Crash Types 62
- Figure 37: Stockton Boulevard (South) 64

Figure 38: Stockton Boulevard (South) Travel Patterns	66
Figure 39: Stockton Boulevard (South) Existing Conditions	67
Figure 40: Stockton Boulevard (South) Crashes	70
Figure 41: Stockton Boulevard (South) Crash Types	71

List of Tables

Table 1: Intersection Level of Service (LOS) Criteria	10
Table 2: StreetScore+ Criteria	11
Table 3: Phase 1 Outreach Events	14
Table 4: Peak Hour Intersection Operations – Broadway.....	20
Table 5: Peak Hour Intersection Operations – Stockton Boulevard (North)	21
Table 6: StreetScore+ Results – Broadway.....	25
Table 7: StreetScore+ Results – Stockton Boulevard (North)	26
Table 8: Peak Hour Intersection Operations – El Camino Avenue.....	35
Table 9: StreetScore+ Results – El Camino Avenue	39
Table 10: Peak Hour Intersection Operations – Florin Road	44
Table 11: StreetScore+ Results – Florin Road	49
Table 12: Peak Hour Intersection Operations – Marysville Boulevard	57
Table 13: StreetScore+ Results – Marysville Boulevard.....	59
Table 14: Peak Hour Intersection Operations – Stockton Boulevard (South)	65
Table 15: StreetScore+ Results – Stockton Boulevard (South).....	69

Appendices

Appendix A – Phase 1 Outreach Summary

Appendix B – Data and Technical Calculations

This page intentionally left blank.

Introduction

This report documents existing transportation conditions for the Vision Zero “Top Five” corridors in Sacramento, California. The Top Five corridors represent approximately one-mile segments with the highest number of fatal and serious crashes involving pedestrians, bicyclists, and motorists. The existing conditions analysis profiles each corridor in terms of the experience each person has driving, riding a bicycle, or walking on the corridor and collision history.

Relationship to Vision Zero Action Plan

To help reach its goal of eliminating traffic fatalities and serious injuries by 2027, the City of Sacramento developed a Vision Zero Action Plan, which was adopted by the City Council in August 2018. The Plan used historic crash data to pinpoint the factors contributing to traffic deaths and serious injuries, and it identified proven safety countermeasures to address those factors through education, engineering, enforcement, and evaluation. This Top Five Corridor Study represents a critical next step in the implementation of City of Sacramento’s Vision Zero Program, focusing efforts on implementing near-term improvements on the five corridors within the City that have the highest rates of collisions that result in fatalities and severe injuries.

Identification of Segments

A High Injury Network (HIN) was developed in July 2017 for the City of Sacramento as part of the Vision Zero Action Plan. The HIN identifies corridors with the highest levels of fatal and severe collisions for all travel modes (i.e., vehicle, bicycle, and pedestrian) to better understand existing transportation safety challenges in the City. Seven years of collision data, from 2009 through 2015, was analyzed from the statewide Transportation Injury Mapping Systems (TIMS). TIMS data includes only those collisions that resulted in an injury, ranging from “complaint of pain” to “fatal.” Collisions resulting in only property damage, either to a vehicle or other property, are not included in the TIMS data set and were not analyzed as part of the Vision Zero Action Plan and HIN development.

A weighted collision score was created for each roadway segment; collisions involving a fatality or severe injury were given a score of 3, and all other injury collisions were given a score of 1. Weighted collision scores were then analyzed as a rate based on segment length. Segments with a weighted collision score greater than 1 per 300 ft of roadway were included on the HIN.

Once the HIN was developed, the network was divided into corridors approximately one mile in length, to allow for direct comparison and selection of the highest priority corridors. Fehr & Peers identified the ten corridors on the HIN with the highest number of fatal and severe injury collisions per mile. The five highest ranking corridors were selected for this initial study and are shown in



Figure 1. Each of these corridors have between 10.4 and 7.1 fatal or severe injury collisions per mile. The next five ranked corridors (#6-10) have fatal and severe injury collision rates between 6.2 and 2.1.

The top five priority corridors are listed below:

- Broadway: Martin Luther King Jr. Boulevard to Stockton Boulevard; Stockton Boulevard: Broadway to 13th Avenue
- El Camino Avenue: Del Paso Boulevard to Steelhead Creek trail crossing
- Florin Road: 24th Street to Munson Way
- Marysville Boulevard: North Avenue to Arcade Boulevard
- Stockton Boulevard (South): McMahon Drive to Patterson Way

FIGURE 1
MAP OF TOP 5 CORRIDORS WITHIN CITY OF SACRAMENTO

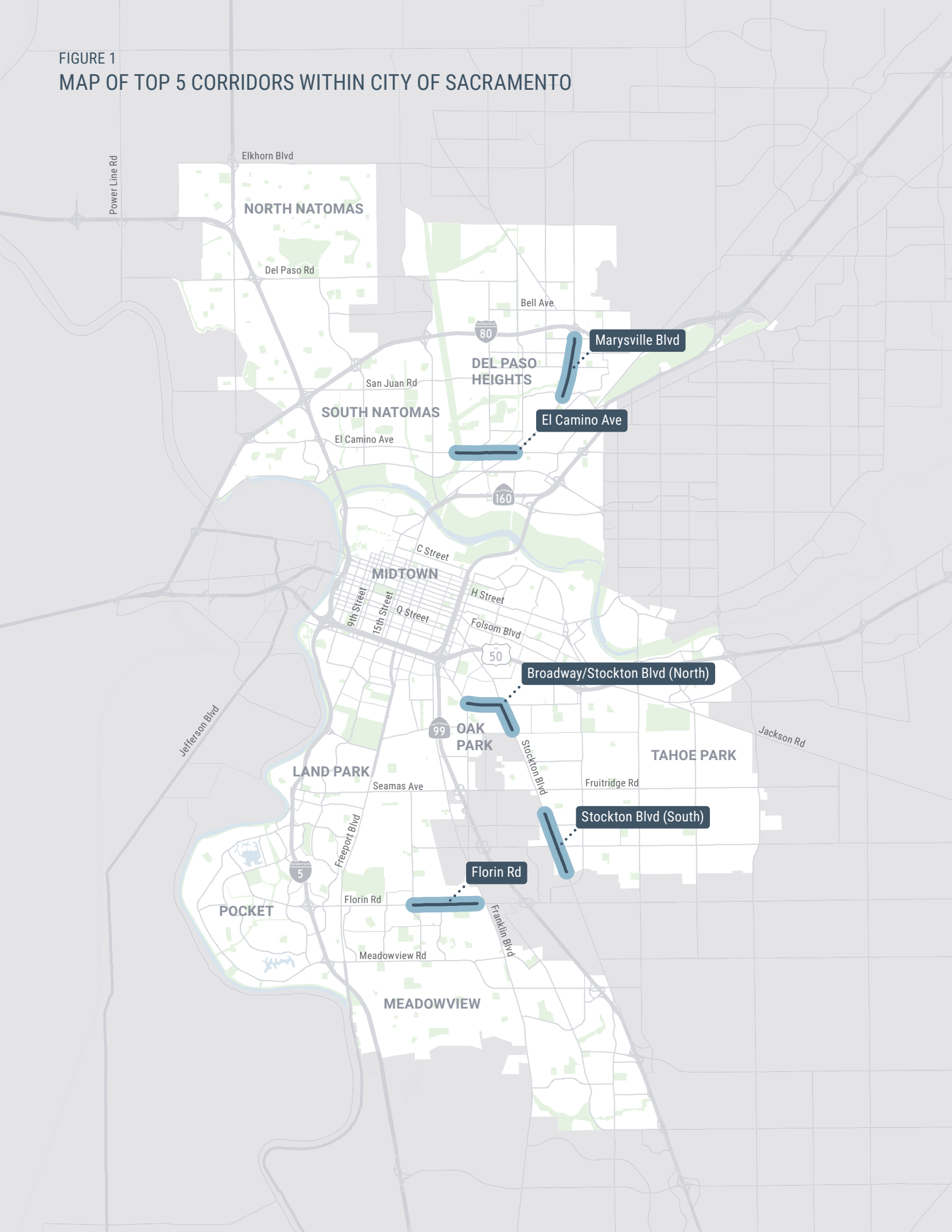
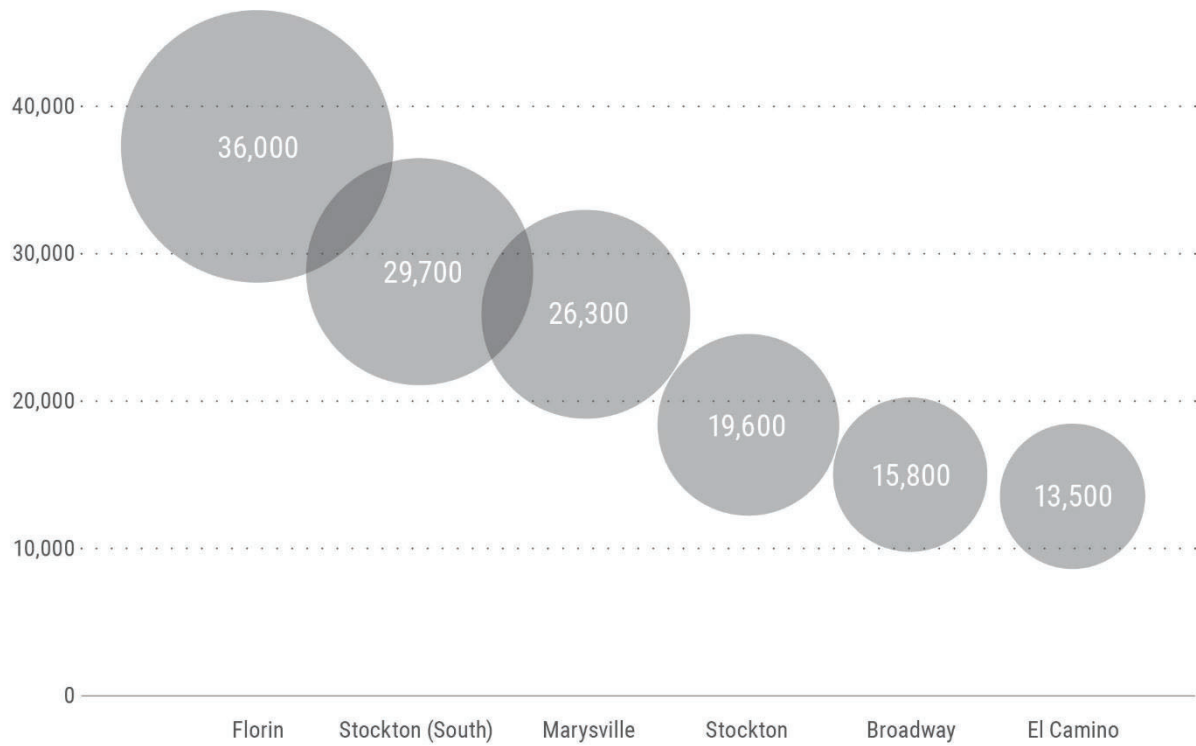



Figure 2: Average Daily Traffic of Top 5 Corridors



Though all these segments are classified as arterials in the *Sacramento General Plan 2035*, they have varying key characteristics, including a range of widths (i.e. travel lanes and right-of-way), speed limits, land use patterns, and traffic volumes.

Figure 2 displays the Average Daily Traffic (ADT) of the Top Five corridors. These values were measured in the early summer of 2018, when schools were in session and the weather was fair. Florin Road carries the most traffic (36,000 vehicles per day) of the Top Five corridors, while El Camino Avenue carries the least traffic (13,500 vehicles per day).

Figure 3: Total Crashes by Year

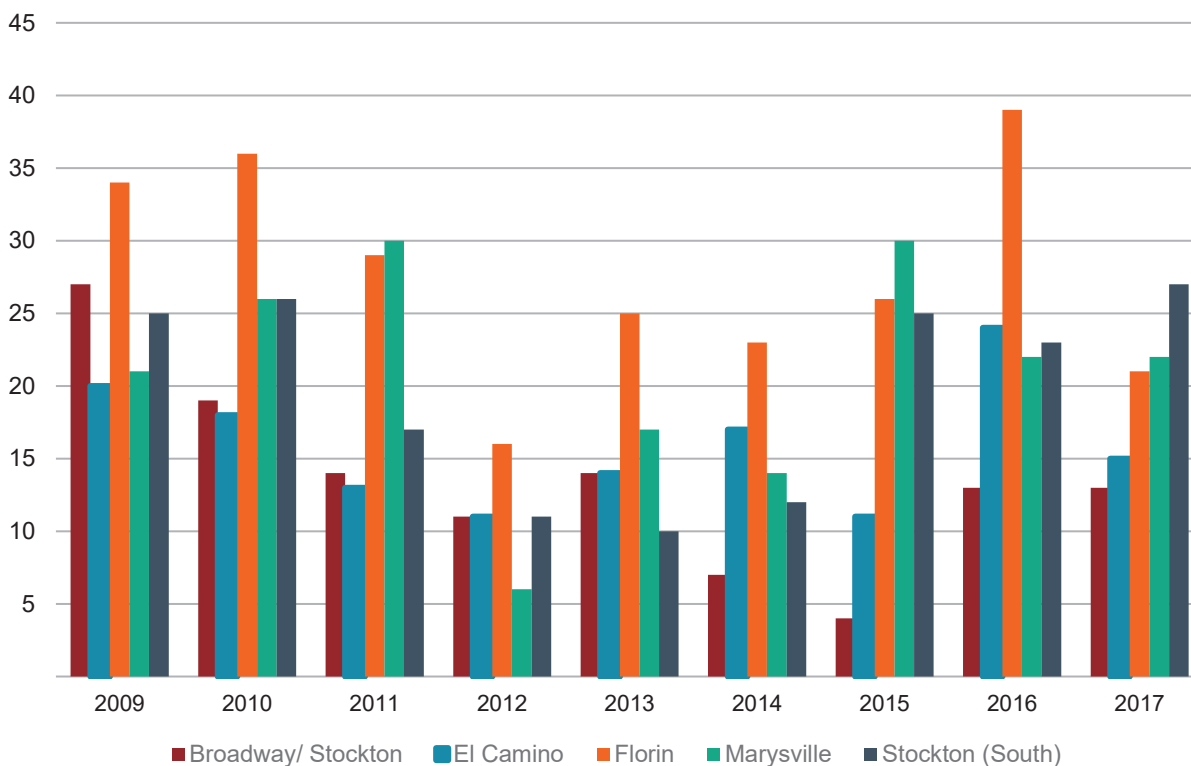
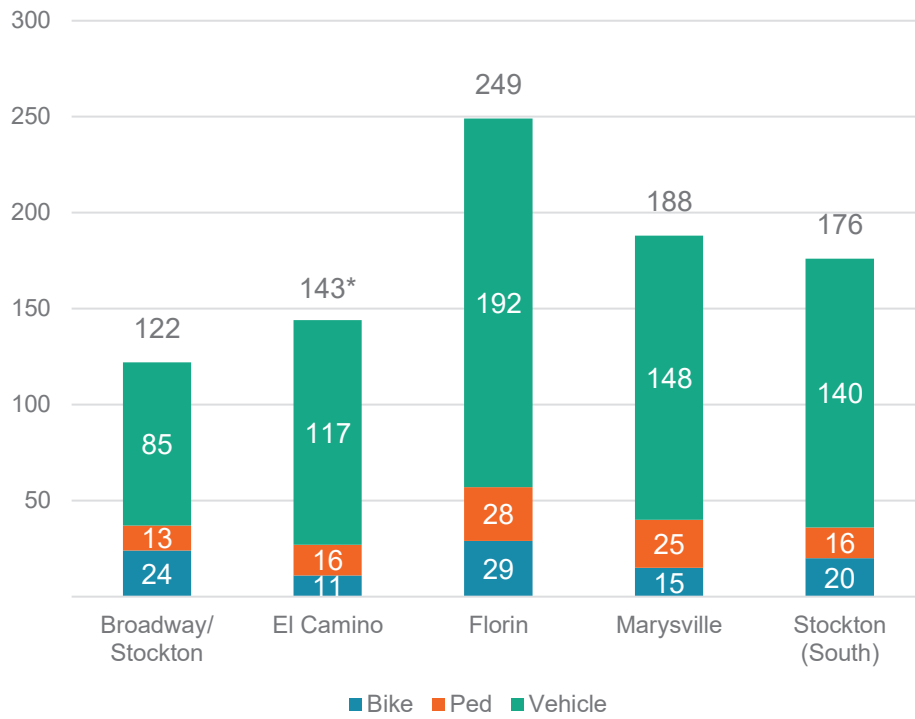

Figure 3 displays the number of annual injury crashes along each corridor between 2009 and 2017. The fewest crashes in a year occurred on the Broadway/Stockton Boulevard (North) corridor in 2015 (four crashes) and the highest number of crashes in a year occurred on Florin Road in 2016 (39 crashes). Broadway/Stockton Boulevard (North) is the corridor with the lowest number of total crashes (122) and Florin Road is the corridor with the highest number of total crashes (249).

Figure 4 displays the number of injury crashes by mode along each corridor as totals and percentages. Despite having the lowest number of crashes overall, the Broadway/Stockton Boulevard (North) corridor has the largest share of crashes involving a bicyclist (24 crashes, or 20 percent). The Marysville Boulevard corridor has the largest share of crashes involving a pedestrian (25 crashes, or 13 percent). However, in absolute numbers, the Florin Road corridor accounts for the highest numbers of crashes involving pedestrians (28 crashes), bicyclists (29 crashes), and vehicle-vehicle crashes (192 crashes).



Figure 4: Total Crashes by Mode



*One collision on El Camino involved both a pedestrian and a bicyclist.

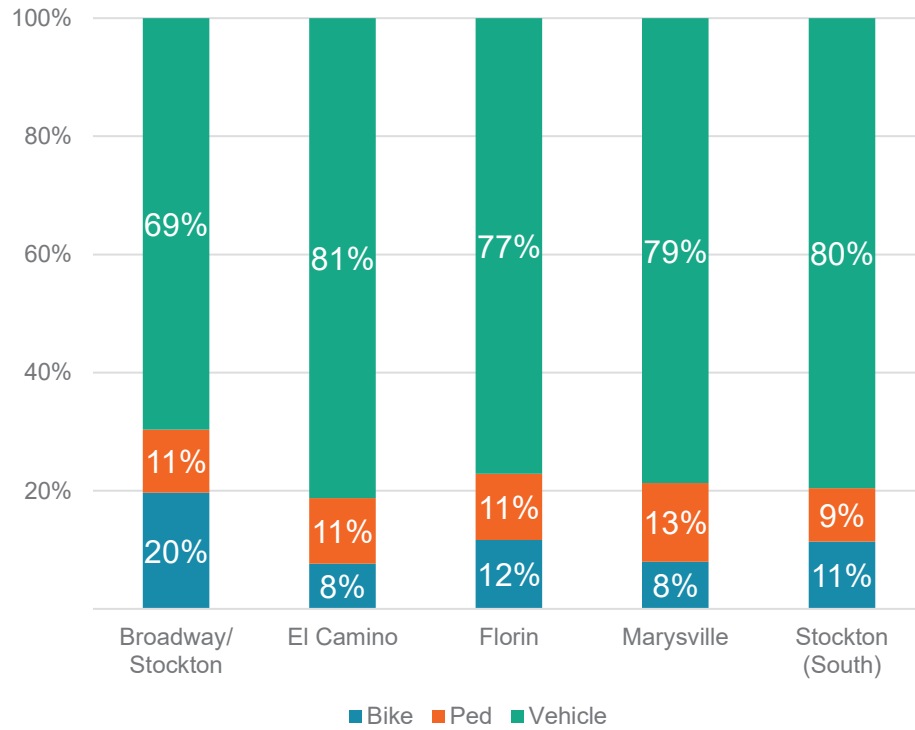

Figure 5 displays the number of crashes that resulted in a fatality or serious injury (also called KSI) along each corridor. Despite having the lowest number of total crashes overall, the Broadway/Stockton Boulevard (North) corridor has the largest share of crashes that result in a fatality or serious injury (15 crashes, or 12 percent of all injury crashes). The Marysville Boulevard corridor has the highest absolute number of crashes resulting in a fatality or serious injury (19 crashes).

Figure 6 displays the number of crashes by mode that resulted in a fatality or serious injury. The Marysville Boulevard corridor has the highest number and largest share of KSI crashes that involved a pedestrian (11 crashes, or 58 percent of KSI crashes). The Stockton Boulevard (South) corridor has the highest number and largest share of KSI crashes that involved a bicyclist (four crashes, or 25 percent of KSI crashes). The El Camino Avenue corridor does not have any bicycle crashes that resulted in a fatality or serious injury.

Throughout this report, the acronym KSI is used to denote crashes where someone was killed or seriously injured.



Figure 5: Total Crashes by Severity

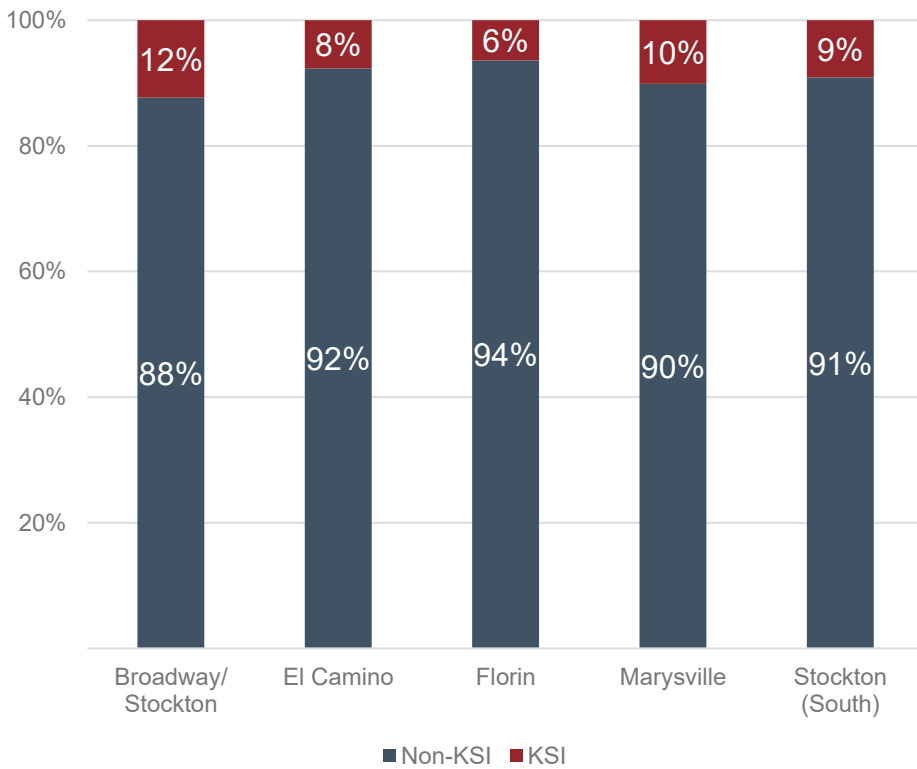
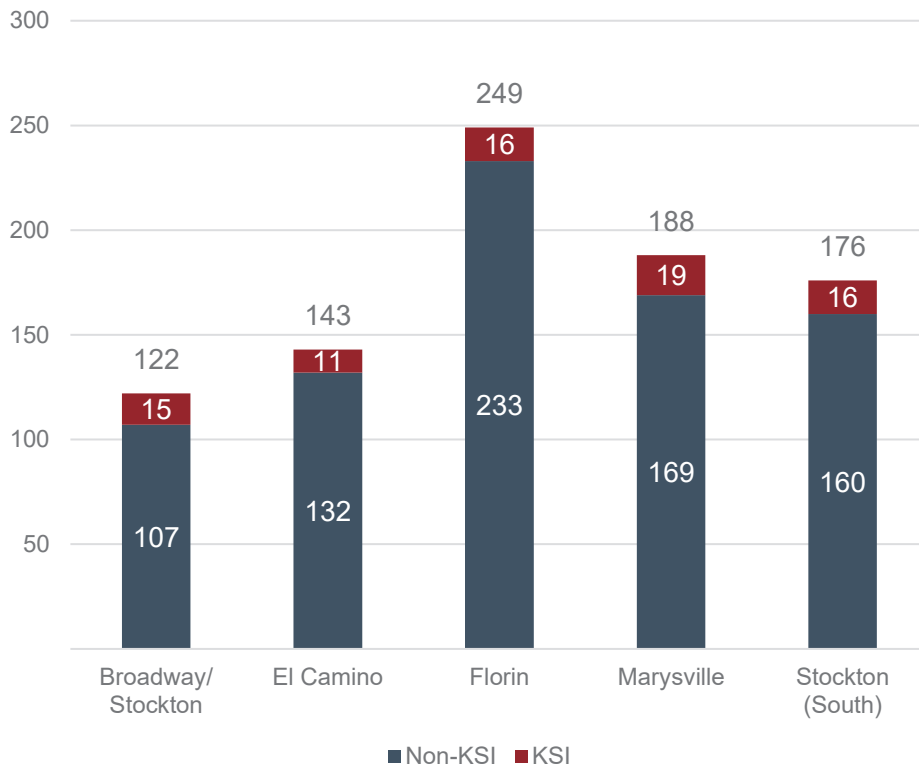
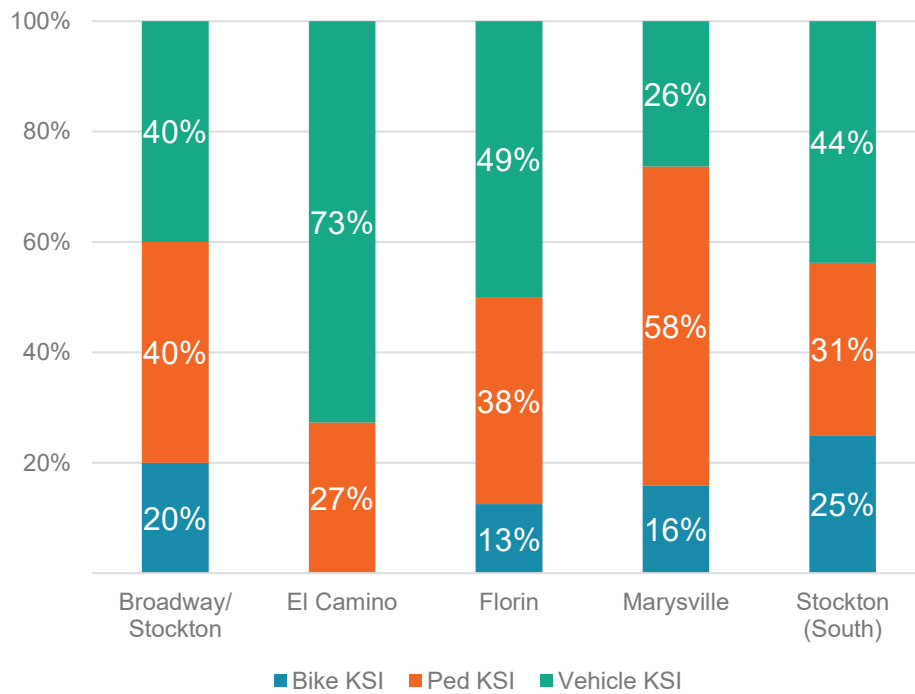
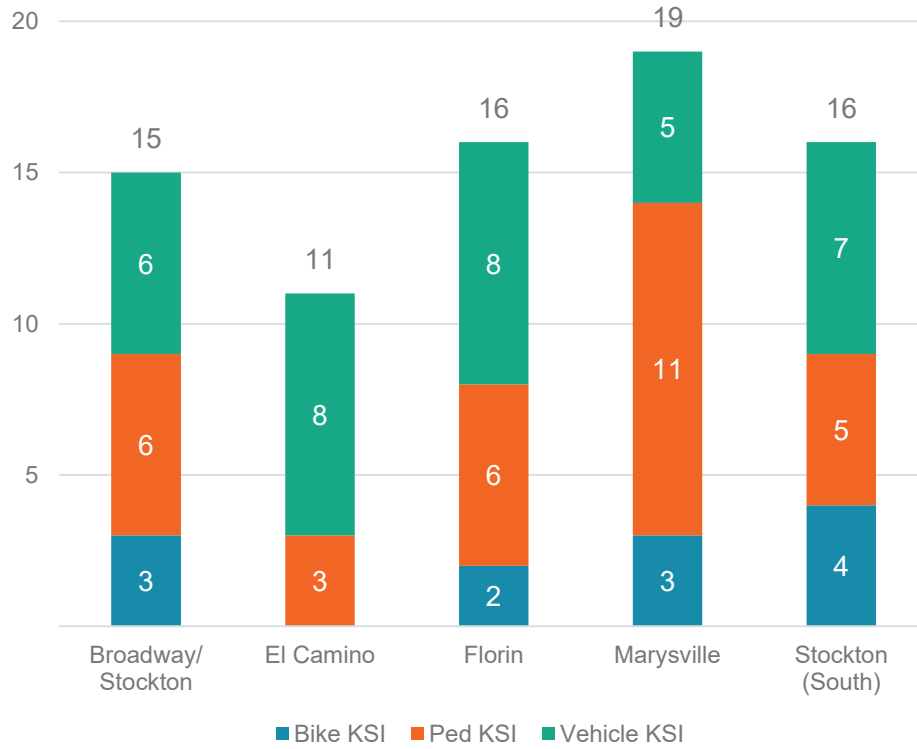

Figure 6: KSI Crashes by Mode





Methodology

This section outlines the methodology developed to quantify the existing conditions of each corridor.

Traffic Operations Analysis

Peak hour vehicular traffic conditions were modeled in SimTraffic 10, micro-simulation software that provides outputs consistent with the *Highway Capacity Manual* by replicating queues and delays at intersections while accounting for signal coordination, queue spillback, and pedestrian crossings, among other factors. Intersection turning movement counts were collected along the Top Five corridors during midweek peak periods when schools were in session and the weather was fair. The counts included vehicular turning movements, heavy vehicles, cyclists, and pedestrian crossings. The results reported for the SimTraffic analysis represent averages of ten runs with outliers omitted, per standard practice. To accurately model the queues along each corridor, the peak hour factor (PHF) was measured and applied to the analysis. The PHF is a measure of intensity of the peak 15 minutes in the peak hour; it is the peak hour volume divided by the peak 15-minute flow rate. Traffic operating conditions are presented as delay and level of service (LOS) at study intersections. Descriptions of level of service are shown in the table below.

Table 1: Intersection Level of Service (LOS) Criteria

Level of Service	Description	Signalized Intersection Delay (s)	Unsignalized Intersection Delay (s)
A	Progression is extremely favorable, and most vehicles arrive during the green phase. Most vehicles do not stop at all. Short cycle lengths may also contribute to low delay.	< 10.0	< 10.0
B	Progression is good, cycle lengths are short, or both. More vehicles stop than with LOS A, causing higher levels of average delay.	> 10.0 to 20.0	> 10.0 to 15.0
C	Higher congestion may result from fair progression, longer cycle lengths, or both. Individual cycle failures may begin to appear at this level, though many still pass through the intersection without stopping.	> 20.0 to 35.0	> 15.0 to 25
D	The influence of congestion becomes more noticeable. Longer delays may result from some combination of unfavorable progression, long cycle lengths, or high V/C ratios. Many vehicles stop, and the proportion of vehicles not stopping declines. Individual cycle failures are noticeable.	> 35.0 to 55.0	> 25.0 to 35.0
E	This level is considered by many agencies to be the limit of acceptable delay. These high delay values generally indicate poor progression, long cycle lengths, and high V/C ratios. Individual cycle failures are frequent occurrences.	> 55.0 to 80.0	> 35.0 to 50.0

Table 1: Intersection Level of Service (LOS) Criteria

Level of Service	Description	Signalized Intersection Delay (s)	Unsignalized Intersection Delay (s)
F	This level is considered unacceptable with oversaturation, which is when arrival flow rates exceed the capacity of the intersection. This level may also occur at high V/C ratios below 1.0 with many individual cycle failures. Poor progression and long cycle lengths may also be contributing factors to such delay levels.	> 80.0	> 50.0

Source: *Highway Capacity Manual, 6th Edition*. Transportation Research Board, 2016.

StreetScore+ Analysis

The pedestrian and cyclist experiences were quantified using StreetScore+, a tool developed by Fehr & Peers that reports a comfort index for biking and walking. StreetScore+ accounts for existing or proposed bicycle and pedestrian facilities of roadway segments. For cycling, StreetScore+ builds off the “Level of Traffic Stress” (LTS) methodology that describes the user tolerance along a given bikeway and includes the National Association of City Transportation Officials’ (NACTO) *Urban Bikeway Guide, 2nd Edition* methodology to document the comfort of separated bikeways. This approach is also applied for pedestrian StreetScore+ analyses, which is based on the NACTO *Urban Streets Design Guide*. The LTS methodology provides a “weakest link” approach to bicycle and pedestrian planning. A description of each StreetScore+ rating is shown in Table 2.

Table 2: StreetScore+ Criteria

StreetScore+	Description
1	Most children can tolerate StreetScore+ 1 and feel safe while bicycling. For pedestrians, Streetscore+ 1 indicates a highly pedestrian-friendly and easily navigable environment for people of all ages and abilities.
2	This is the highest level of stress that the adult bicyclists will tolerate while still feeling safe. For pedestrians, walking is generally comfortable, but parents may not feel comfortable letting their children walk alone.
3	Bicyclists who are considered “enthused and confident” but still prefer having their own dedicated space for riding will tolerate this level of stress and feel safe while cycling. For pedestrians, walking is uncomfortable but possible, with some barriers that make walking uninviting or uncomfortable.
4	For bicyclists, this is tolerated only by those characterized as “strong and fearless,” which comprises a small percentage of the population. These roadways have high speed limits, multiple travel lanes, limited or non-existent bike lanes and signage, and large distances to cross at intersections. For pedestrians, walking is very uncomfortable or even impossible. Streets have limited or no accommodation and may be unsafe for people walking.

Source: *StreetScore+: Comfort and Level of Traffic Stress Scoring Methodology for Bicyclist and Pedestrians*. Fehr & Peers, 2016.

Factors influencing StreetScore+ results include:



- Number of travel lanes
- Speed of traffic
- Number of vehicles
- Presence, width, and separation of bike lanes
- Presence, width, and separation of sidewalks

Collision Analysis

Crash Database

In the summer of 2018, Fehr & Peers built a database for each of the five corridors using geocoded crash data for the years 2009 through 2017 from the Transportation Injury Mapping System (TIMS), managed by the Safe Transportation Research and Education Center (SafeTREC) at the University of California, Berkeley. Crash data include only those crashes that resulted in an injury and do not include crashes that resulted in property damage only. The crash data was retrieved from the TIMS system in June of 2018. At the time of retrieval, crash data for the years 2015, 2016 and 2017 were provisionally available and had not yet been finalized by SafeTREC.

Crashes were identified for each corridor if the TIMS geocoded location fell within 250 feet of the corridor centerline and if the study corridor was reported as either the primary street or cross street within the crash record. For each corridor, the number of crashes by mode (pedestrian, bicyclist, or vehicle-vehicle) is reported along with whether crashes resulted in a fatality or serious injury. This data is also reported for each intersection and midblock location. For each intersection location, a collision analysis sphere of influence was determined based on the size of the intersection and the length of turn lanes associated with the intersection. This identification process was performed for each intersection. The spheres of influence range from 150 feet to 250 feet on each approach. Collisions falling within the sphere of influence of two intersections were assigned based on the reported streets in the crash record. Any collisions located beyond the sphere of influence were either associated with the adjacent intersection or determined to be a midblock collision. A maximum of 250 feet was used for this project to limit the collision dataset for each location to that which would be acceptable under an HSIP funding application. These spheres of influence may be different than those ordinarily used for analysis in some locations.

Serious Injury Crashes

Serious injuries (also called severe injuries by the California Highway Patrol) obtained in a traffic crash can result in a number of catastrophic impacts to those involved, including permanent disability, lost productivity and wages, and ongoing healthcare costs. Serious injuries include:

- Broken or fractured bones
- Dislocated or distorted limbs
- Severe lacerations
- Severe burns

- Skull, spinal, chest or abdominal injuries
- Unconsciousness at or when taken from the collision scene

Roadway and Contextual Data

Fehr & Peers collected additional data related to roadway and other contextual characteristics along each corridor. In most cases, original GIS data was provided by the City as part of the Vision Zero Action Plan analysis. In some cases, new data was collected through a survey of third-party maps. This data was then verified through field visits as part of the traffic operations analysis process. The roadway and contextual data displayed as part of the crash analysis includes:

- Number of lanes
- Posted speed
- Presence and type of bicycle facilities
- Presence and type of marked crosswalks
- Intersection configuration
- Intersection control type (including Pedestrian Hybrid Beacons)
- Bus stops
- Rail crossings
- Key institutional locations

Crash Types

As part of the crash analysis along each corridor, Fehr & Peers identified key crash types. Crash types were determined based on data within the crash records themselves, and include the following categories:

- Primary violation category (e.g. unsafe speed, improper turning, wrong side of road, under the influence, signal or sign violation)
- Vehicle movement preceding collision (e.g. proceeding straight, left turns, right turns)
- Crash category (e.g. broadside, side swipe, rear end, head on)
- Day of week (e.g. weekend, weekday)
- Time of day (e.g. morning, daytime, nighttime)
- Time of year (e.g. winter)
- Location of pedestrian at time of collision (e.g. crossing in crosswalk, crossing not in crosswalk, in road)
- Age of victim (e.g. senior victims)
- Whether alcohol was involved

The reported crash types represent a sample of trends for each corridor, with each crash type occurring at least three times on the corridor but usually occurring much more often. These crash types represent only a sample and do not encompass all crash types occurring along a given corridor. If a crash type is unique to a corridor (i.e. the trend was not prevalent along the other corridors), it is included in corridor crash types list. Vehicle crash types highlight trends among all crashes along that corridor (predominantly vehicle-vehicle crashes, with no pedestrians or bicycles involved). Pedestrian crash types highlight trends among the crashes involving pedestrians. Bicycle crash types highlight trends among the crashes involving bicyclists. Crash types represent trends within the full set of crashes for each corridor but are also displayed for the intersections where a crash type occurs at least three times. Across all corridors, there is a



predominant trend of crash types involving vehicles that are proceeding straight or stopped, unsafe speed violations, and rear end crashes.

Public Outreach

In late 2018, community outreach events were held for each corridor to build community awareness about the Vision Zero Top Five Corridors study, present an overview of existing conditions and crash analytics along each corridor, and obtain input on people’s experiences traveling along each corridor. These events comprised Phase 1 of the outreach program for this project.

Six pop-up events and two community workshops were held at locations near each corridor to engage community members who regularly travel along the corridor. Each event included display boards with technical information about the relevant corridor, which included key characteristics (e.g. roadway cross-sections, distance between crosswalks, etc.), crash analytics between 2009 and 2017, and corridor-wide crash types for each mode of transportation. During each outreach event, attendees were asked to review the project boards and share their experiences traveling along the corridor. A detailed summary of the Phase 1 outreach efforts is provided in Appendix A (*Community Outreach Summary Report – Phase 1*).

Table 3 lists each of the Phase 1 outreach events.

Table 3: Phase 1 Outreach Events

Corridor	Event	Location	Date
Broadway/Stockton Boulevard (North)	Pop-up event at Fall Family Festival	Oak Park Community Center	October 25, 2018
	Pop-up event	Broadway/Stockton Boulevard WB transit stop	November 7, 2018
El Camino Avenue	Old North Sacramento/Dixieanne Community Association Meeting	701 Dixieanne Avenue	November 10, 2018
	Pop-up event	Grocery Outlet	December 4, 2018
Florin Road	Community Workshop	Luther Burbank High School	November 15, 2018
Marysville Boulevard	Mutual Assistance Harvest Festival	Robertson Community Center	October 27, 2018
	Hagginwood Community Association Meeting	William J. Kinney Police Facility	December 4, 2018
Stockton Boulevard (South)	Community Workshop	Peter Burnett Elementary School	November 5, 2018

Source: *Community Outreach Summary Report – Phase 1*. City of Sacramento, 2018.

Broadway/Stockton Boulevard (North)

This segment is comprised of two roadways: Broadway between Martin Luther King Jr. Boulevard and Stockton Boulevard; and Stockton Boulevard between Broadway and 14th Avenue.

Existing Conditions

Traffic counts were collected on this corridor on May 31, 2018. The observed AM peak hour occurred between 7:15 and 8:15 AM with a PHF of 0.87 and two percent heavy vehicle count. The observed PM peak hour occurred between 4:30 and 5:30 PM, with a 0.94 PHF and one percent heavy vehicle count. During both peak hours, at least five bicyclists traveled through and at least 16 pedestrians crossed at each study intersection on Broadway, and on Stockton Boulevard, at least 15 bicyclists traveled through and at least ten pedestrians crossed at each study intersection. The measured ADT of Broadway was 15,800 vehicles, and the measured ADT of Stockton Boulevard was 19,600.

Figure 7 and Figure 8 show the travel patterns on Broadway and Stockton Boulevard. Figure 9 and Figure 10 summarize existing travel characteristics for these corridors.

FIGURE 7 BROADWAY TRAVEL PATTERNS

Thursday, May 31st, 2018. 7:15-8:15 AM & 4:30-5:30 PM

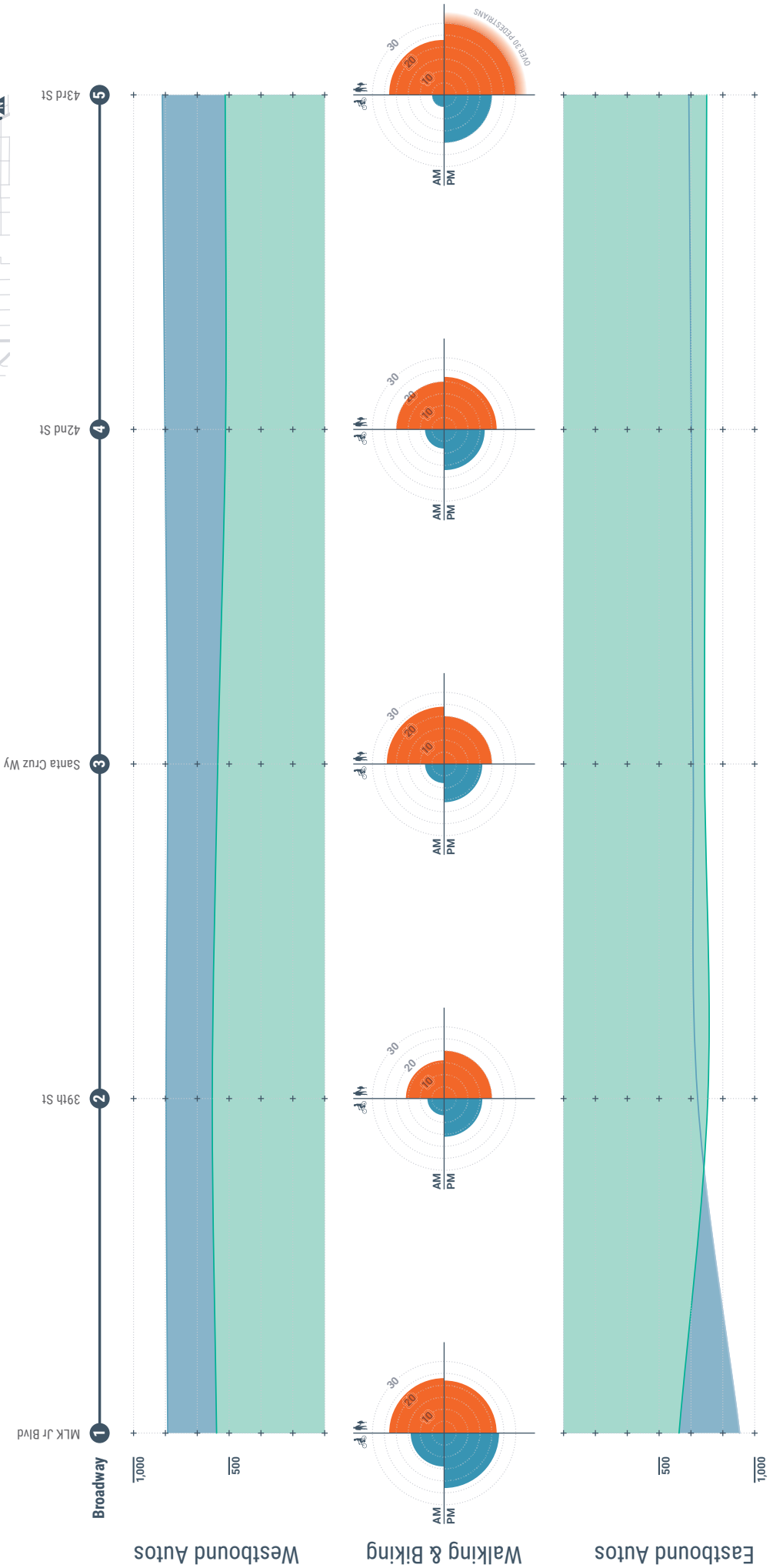
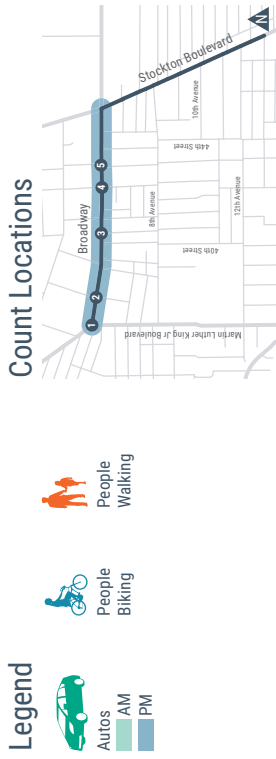

FIGURE 8

STOCKTON BOULEVARD TRAVEL PATTERNS

Thursday, May 31st, 2018. 7:15-8:15 AM & 4:30-5:30 PM

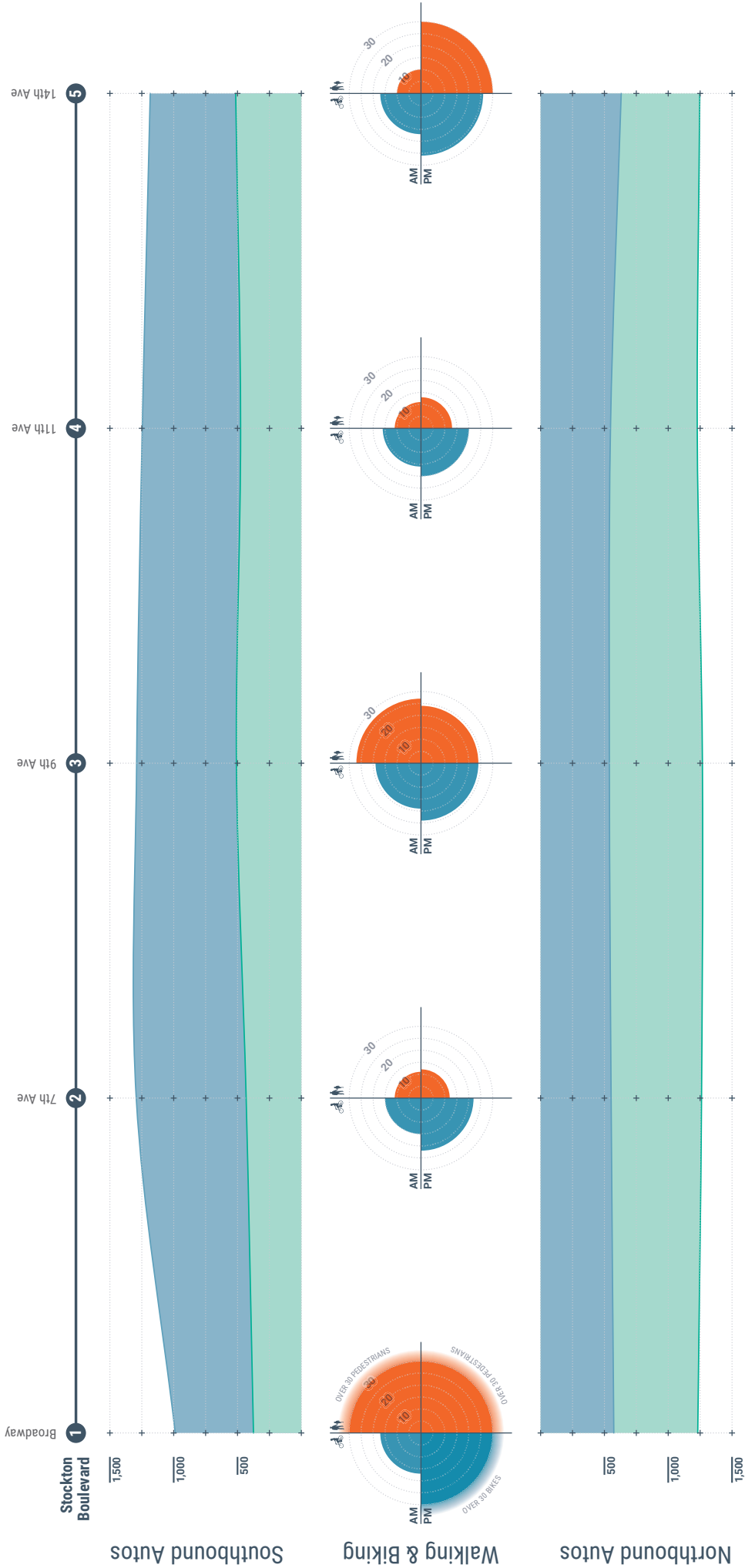

FIGURE 9 BROADWAY - EXISTING CONDITIONS

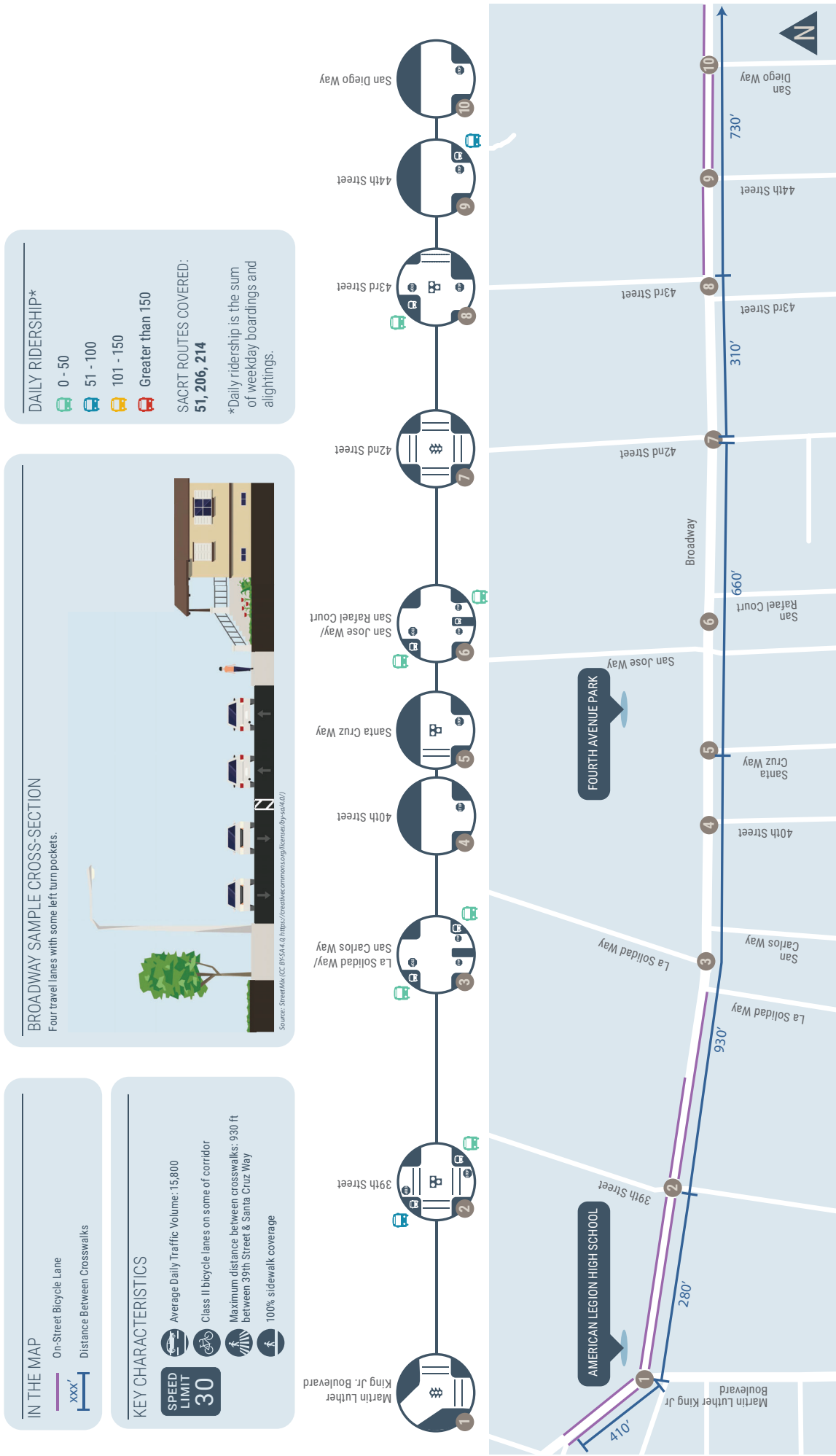
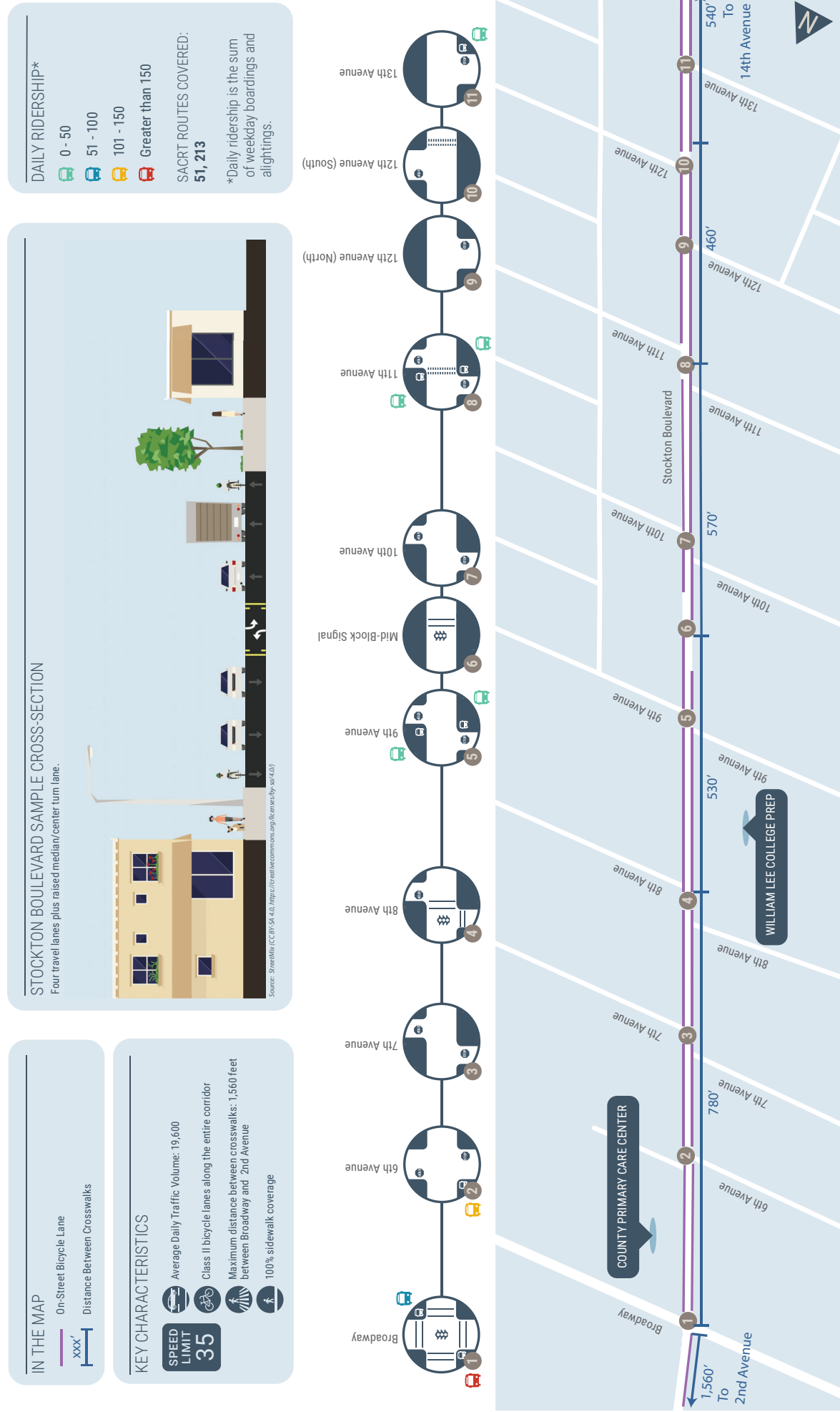

FIGURE 10

STOCKTON BOULEVARD - EXISTING CONDITIONS





Vehicular Facilities

Broadway

The segment of Broadway is comprised of four travel lanes with some left-turn pockets at key intersections. The posted speed limit is 30 miles per hour. For this segment of Broadway, the intersections are closely-spaced, and the legs of the Martin Luther King Jr. Boulevard/Broadway intersection are skewed (i.e., not at a right angle, 90 degrees). On-street parking is prohibited along the corridor, except for a loading zone by the Arbors apartments.

The *Sacramento General Plan 2035* classifies Broadway as an arterial. Policy M.1.2.2 dictates that the City will strive to operate this segment at LOS D or better for vehicles during typical weekday conditions, including the AM and PM peak hour.

Table 4 shows the intersection operations along Broadway during peak hours. All intersections operate acceptably according to Policy M.1.2.2 of the *Sacramento General Plan 2035*. The highest delays to vehicles along this segment occur during the AM peak hour at the Stockton Boulevard/Broadway intersection. Appendix B includes detailed calculations of these results.

Table 4: Peak Hour Intersection Operations – Broadway

Intersection	Traffic Control ¹	AM Peak Hour		PM Peak Hour	
		Delay ² (s)	LOS ³	Delay ² (s)	LOS ³
Martin Luther King Jr. Boulevard/Broadway	Signal	13.7	B	14.5	B
39 th Street/Broadway	SSSC	2.1 (20.2) (NB TH)	A (C)	2.8 (6.1) (EB LT)	A (A)
Santa Cruz Way/Broadway	SSSC	2.5 (18.1) (SB LT)	A (C)	0.8 (7.1) (EB LT)	A (A)
42 nd Street/Broadway	Signal	5.2	A	4.3	A
43 rd Street/Broadway	SSSC	1.4 (14.8) (SB TH)	A (B)	1.7 (9.1) (EB LT)	A (A)
Stockton Boulevard/Broadway	Signal	41.1	D	33.6	C

Notes:

1. Signal = traffic signal-controlled intersection; SSSC = side-street stop-controlled intersection
2. Average control delay for signalized intersections is the weighted average for all movements. For SSSC intersections, the delay and LOS for the highest delay movement is shown in parentheses.
3. LOS = level of service; calculated based on methodologies contained in the *Highway Capacity Manual, 6th Edition* (Transportation Research Board, 2016).

Source: Fehr & Peers, 2018.

Stockton Boulevard

The segment of Stockton Boulevard is comprised of four travel lanes plus a median/center left-turn lane. The posted speed limit is 35 miles per hour. Many intersections are offset (i.e. the east and west legs are not aligned) and many intersections operate as side-street stop-controlled, except for the segment's

terminal intersections at the Broadway/14th Avenue and the Stockton Boulevard/8th Avenue (East) intersections, which are signalized. On-street parallel parking is prohibited along this segment.

This segment is characterized as an arterial by the *Sacramento General Plan 2035*. The LOS D standard of Policy M.1.2.2 applies to this segment. Table 5 shows that all intersections on this segment operate acceptably during both the AM and PM peak hours except for Stockton Boulevard/14th Avenue which operates at LOS E during both peak hours. Appendix B includes detailed calculations of these results.

Table 5: Peak Hour Intersection Operations – Stockton Boulevard (North)

Intersection	Traffic Control ¹	AM Peak Hour		PM Peak Hour	
		Delay ² (s)	LOS ³	Delay ² (s)	LOS ³
Stockton Boulevard/Broadway	Signal	41.1	D	33.6	C
Stockton Boulevard/7 th Avenue	SSSC	6.7 (39.5) (WB RT)	A (E)	0.8 (13.6) (EB LT)	A (B)
Stockton Boulevard/9 th Avenue	SSSC	2.3 (26.4) (WB TH)	A (C)	1.1 (21.9) (EB LT)	A (C)
Stockton Boulevard/11 th Avenue (West)	SSSC	1.1 (22.8) (WB LT)	A (C)	1.7 (25.4) (EB LT)	A (D)
Stockton Boulevard/14 th Avenue	Signal	62.3	E	60.1	E

Notes:

1. Signal = traffic signal-controlled intersection; SSSC = side-street stop-controlled intersection
2. Average control delay for signalized intersections is the weighted average for all movements. For SSSC intersections, the delay and LOS for the highest delay movement is shown in parentheses.
3. LOS = level of service; calculated based on methodologies contained in the *Highway Capacity Manual, 6th Edition* (Transportation Research Board, 2016).

Bold text indicates unacceptable operations.

Source: Fehr & Peers, 2018.

Transit Facilities

Line 51 of Sacramento Regional Transit (RT) operates on Broadway and Stockton Boulevard with 15-minute headways for its weekday operations. This line connects Florin Towne Centre with the Sacramento Valley Station. On weekdays, it operates between 5:30 AM to 10:30 PM. On weekends and holidays, the line operates with 30-minute headways between 6:00 AM and 11:00 PM on Saturdays and between 6:00 AM and 9:30 PM on Sundays and holidays. Line 51 has the highest ridership of any bus route in the RT system.

Sacramento Regional Transit also operates two school bus lines on Broadway and one school bus line on Stockton Boulevard, each of which make one trip to school in the morning and one trip from school in the afternoon. Line 206 provides service from the Stockton Boulevard/Broadway intersection to California Middle School, and Line 214 provides service from the T Street/34th Street intersection to Kit Carson Middle School. Both routes serve stops on Broadway. Line 213 serves stops on Stockton Boulevard between West Campus High School and Kit Carson Middle School. The school bus lines do not provide weekend or holiday service.



Most bus stops along Broadway lack passenger amenities and are marked by signage only. There is a bench for the eastbound stop at the Broadway/44th Street intersection, and a transit shelter for the westbound stop at Stockton Boulevard/Broadway.

Many bus stops on this segment of Stockton Boulevard have transit shelters including the southbound stop at Stockton Boulevard/6th Avenue, the southbound stop at Stockton Boulevard/9th Avenue, the southbound stop at Stockton Boulevard/11th Avenue, the southbound stop at Stockton Boulevard/14th Avenue, and the northbound stop at Stockton Boulevard/14th Avenue.

Pedestrian Facilities

Broadway

The Broadway segment of this corridor has sidewalks that are approximately 6.5 feet wide on both sides of the street. The sidewalk is mostly adjacent to the road, except for a landscape buffer on the south side between Martin Luther King Jr. Boulevard and east of 39th Street. Lighting is provided by roadway overhead light poles.

There are marked crosswalks across Broadway at all signalized intersections along this segment. The northwest leg of Martin Luther King Jr. Boulevard/Broadway intersection does not have a striped crosswalk or pedestrian phase. Additionally, there are crosswalks on the west leg of the 39th Street/Broadway intersection, on the west leg of the Santa Cruz Way/Broadway intersection, and on the east leg of the 44th Street/Broadway intersection, all of which operate with side-street stop control. There are also pedestrian-hybrid beacons at these crosswalks, which stop vehicular traffic when activated by a pedestrian push-button. All crosswalks on this section of the corridor have basic markings striped with solid lines. The maximum distance between crosswalks is 930 feet between 39th Street and Santa Cruz Way. During field observations, it was noted that frequent jaywalking occurs on Broadway, particularly mid-block between San Diego Way and Stockton Boulevard.

Stockton Boulevard

There are sidewalks on both sides of the street of this segment that are typically 5 feet in width. Some segments have landscaped buffers, while in others the sidewalk is adjacent to the roadway. Lighting is provided by overhead traffic lighting.

There are marked crosswalks across Stockton Boulevard at the signalized intersections of this segment. The north legs of the Stockton Boulevard/8th Avenue (East) and Stockton Boulevard/14th Avenue intersections do not have crosswalks or pedestrian phases. Additionally, there is a marked crosswalk at the Stockton Boulevard/11th Avenue intersection, which is an offset (i.e. east and west legs are not aligned) side-street stop-controlled intersection. The crosswalk is on Stockton Boulevard between the east and west legs of 11th Avenue.

The maximum distance between marked crosswalks along the segment is 780 feet between the south leg of Broadway and 8th Avenue. Though outside the limits of the study corridor, the distance between the

north leg of the Stockton Boulevard/Broadway intersection (the northern terminus of this corridor) and the nearest crosswalk to the north at 2nd Avenue is 1,260 feet.

A marked mid-block pedestrian crossing is located between 9th Avenue and 10th Avenue, where a full signal controls northbound and southbound traffic when the pedestrian button is pushed to activate a pedestrian crossing phase.

All crosswalks along this section of the corridor feature basic striping treatments with solid lines, except for the crosswalk at Stockton Boulevard/11th Avenue, which has a “triple-four” configuration.

Figure 11: Stockton Boulevard

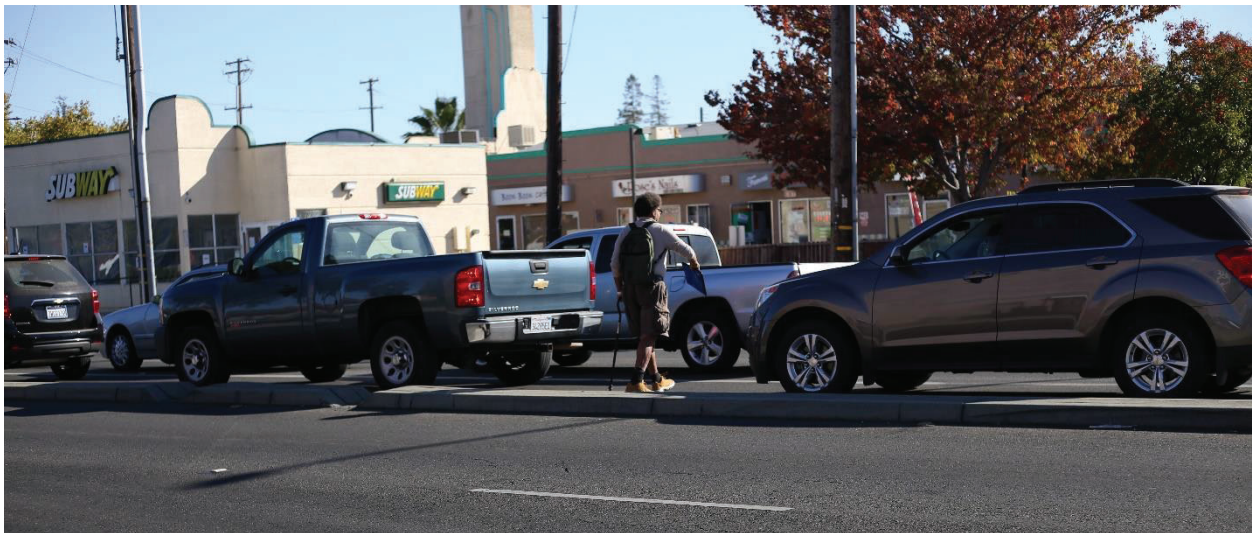

Bicycle Facilities

Figure 12: Stockton Boulevard/Broadway Intersection



Broadway

Class II bike lanes, 5 feet wide, are located along portions of the Broadway corridor, with gaps on the north side between west of La Solidar Way and 43rd Street and on the south side between La Solidar Way and 44th Street. Based on field observations, the bike lanes are typically not blocked by obstructions such as parked vehicles, trash cans, leaf piles, etc.

Stockton Boulevard

There are Class II bike lanes on this segment of Stockton Boulevard, typically between 5 and 6 feet in width, along most of the corridor which experience minimal blockage. There are gaps in the bike lanes on the east side of Stockton Boulevard north of Broadway, and on both sides of Stockton Boulevard around the midblock signal between 9th Avenue and 10th Avenue.

StreetScore+

Broadway

The StreetScore+ results for the Broadway segment are shown in Table 6. Appendix B of this report includes detailed calculations of these results. Many segments with Class II bike lanes have a bicycle score of 3 because there are five travel lanes, meaning that “enthusied and confident” bicyclist will tolerate the level of stress of this segment. Segments without the Class II bike lanes typically have a rating of 4 because of high speeds, meaning that only “strong and fearless” cyclists will tolerate traveling on the segment.

Frequent driveway curb cuts and no landscaping buffer results in score of 3 for pedestrians, which means that walking is uncomfortable but possible.

Table 6: StreetScore+ Results – Broadway

Segment	Direction	Bicycle StreetScore+	Pedestrian StreetScore+
Broadway between 38th Street and Martin Luther King Jr. Boulevard	EB	2	3
	WB	2	3
Broadway between Martin Luther King Jr. Boulevard and 39th Street	EB	3	2
	WB	3	3
Broadway between 39th Street and Santa Cruz Way	EB	4	3
	WB	4	3
Broadway between Santa Cruz Way and 42nd Street	EB	4	3
	WB	4	3
Broadway between 42nd Street and 43rd Street	EB	4	3
	WB	4	3
Broadway between 43rd Street and Stockton Boulevard	EB	4	3
	WB	3	3
Broadway between Stockton Boulevard and 49th Street	EB	4	3
	WB	3	3

StreetScore+ ratings range from 1 through 4 with 1 representing low stress bicycle and pedestrian travel conditions and 4 representing high stress bicycle and pedestrian travel conditions.
Source: Fehr & Peers, 2018.

Stockton Boulevard

Table 9 shows the StreetScore+ results for this segment of Stockton Boulevard. Appendix B of this report includes detailed calculations of these results.

Because of the 40-mile-per-hour posted speed limit, most segments of this corridor have a bicycle score of 3, meaning enthusiastic cyclists will tolerate this level of stress. For the segments of Stockton Boulevard adjacent to Broadway, there is either no bike lane or a five-foot bike lane, resulting in a rating of 4, which indicates that likely only “strong and fearless” bicyclists will feel comfortable traveling on the segment.

The segments also have a pedestrian score of 3 because the sidewalk is less than six feet wide and crosswalk spacing (greater than 400 feet). Additionally, many segments also do not have a landscape buffer and driveway curb cuts in the sidewalk. A rating of 3 indicates that walking is uncomfortable but possible.



Table 7: StreetScore+ Results – Stockton Boulevard (North)

Segment	Direction	Bicycle StreetScore+	Pedestrian StreetScore+
Stockton Boulevard between 4 th Avenue and Broadway	NB	4	3
	SB	4	3
Stockton Boulevard between Broadway and 7 th Avenue	NB	4	3
	SB	4	3
Stockton Boulevard between 7 th Avenue and 9 th Avenue	NB	3	3
	SB	3	3
Stockton Boulevard between 9 th Avenue and 11 th Avenue	NB	3	3
	SB	3	3
Stockton Boulevard between 11 th Avenue and 14 th Avenue	NB	3	3
	SB	3	3
Stockton Boulevard between 14 th Avenue and 15 th Avenue	NB	3	3
	SB	3	3

StreetScore+ ratings range from 1 through 4 with 1 representing low stress bicycle and pedestrian travel conditions and 4 representing high stress bicycle and pedestrian travel conditions.
Source: Fehr & Peers, 2018.

Collision Analysis

Figure 14 and Figure 15 show the crashes on Broadway and summarize the crash types. Figure 16 and Figure 17 show the crashes on Stockton Boulevard and summarize the crash types. These figures also served as display boards at the outreach meetings for this corridor.

Broadway

Along the Broadway section, the most crashes occurred at the Martin Luther King Jr. Boulevard and San Jose Way/San Rafael Court intersections (ten crashes at each location). The most KSI crashes occurred at the 39th Street intersection (two vehicle and one pedestrian). Pedestrian KSI crashes also occurred at 40th Street and Santa Cruz Way. One bicycle KSI crash occurred at San Diego Way.

Crashes involving a vehicle proceeding straight or stopped, unsafe speed violations, and rear end crashes were common along all five corridors, and Broadway is no exception. Other common crash types include:

- Vehicle left-turns (Martin Luther King Jr. Boulevard, San Jose Way/San Rafael Court, and 42nd Street)
- Sideswipe crashes, including those involving a bicyclist (42nd Street)
- Broadside crashes (San Jose Way/San Rafael Court)

Stockton Boulevard

Along the Stockton section, the most crashes occurred at the Stockton Boulevard/Broadway intersection (34 crashes). There were four KSI crashes at this location, including two pedestrian and one bicyclist crash. Another pedestrian KSI crash occurred at 6th Avenue and a second bicycle KSI crash occurred at 11th Avenue.

Crashes involving a vehicle proceeding straight or stopped, unsafe speed violations, and rear end crashes were again common along this segment of Stockton Boulevard. Because most crashes along this corridor occur at the Broadway intersection, that location largely determines the other common crash types, including:

- Vehicle left turns
- Broadside crashes, including those involving bicyclists
- Pedestrian hit while crossing in a crosswalk
- Bicycle crashes involving right-turning vehicles
- Bicycle crashes occurring before noon

Figure 13: Stockton Boulevard





Feedback

Many of the comments received at outreach meetings for the Broadway/Stockton Boulevard corridor mentioned speeding, pedestrian crossings, enforcement, and bicycle safety. These comments are detailed in the *Community Outreach Report – Phase 1*, which is included in Appendix A.



FIGURE 14

BROADWAY CRASHES

CORRIDOR CRASH SUMMARY (2009-2017)

	38		8		11
FATAL AND SEVERE CRASHES	4	3	1		

KEY CHARACTERISTICS

-  **SPEED LIMIT 30**
-  Four travel lanes with some left turn pockets.
-  Class II bicycle lanes along short portions of the corridor.

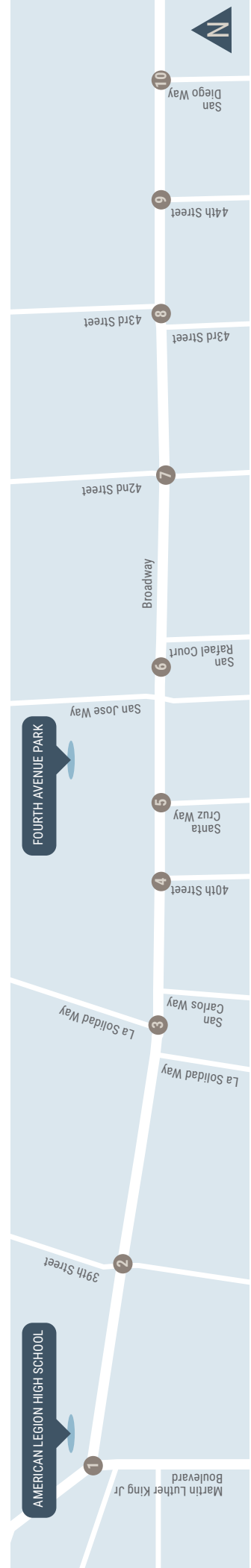
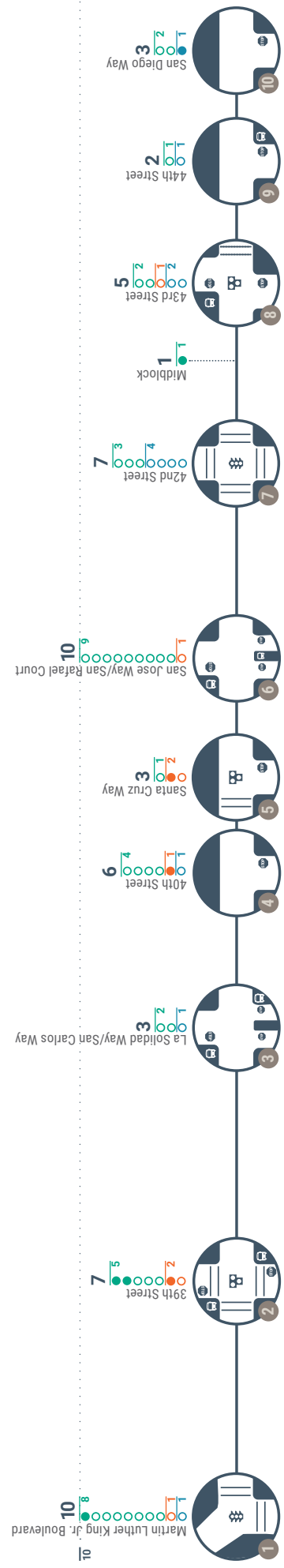

FIGURE 15

CORRIDOR-WIDE CRASH TYPES

VEHICLE

Unsafe Speed

"Unsafe Speed" was the most common violation, cited in 28% of all crashes.

1 2 3 4 5 6
7 8 9 10

Proceeding Straight

More than 2/3 of drivers were proceeding straight or stopped at the time of the crash.

1 2 3 4 5 6
7 8 9 10

Sideswipe

Sideswipe was the second most common crash type - 23% of all crashes.

1 2 3 4 5 6
7 8 9 10

Not in Crosswalk

Half of pedestrians hit were crossing outside of a crosswalk at the time of the crash.

1 2 3 4 5 6
7 8 9 10

Weekend

Nearly 2/3 of pedestrian crashes occurred on Friday or Saturday.

1 2 3 4 5 6
7 8 9 10

Rear End

Rear End was the most common crash type - 25% of all crashes.

1 2 3 4 5 6
7 8 9 10

Left Turns

Nearly 2/3 of drivers who were turning at the time of the crash were making a left turn.

1 2 3 4 5 6
7 8 9 10

Broadside

Nearly 20% of all crashes were broadside, also called T-Bone.

1 2 3 4 5 6
7 8 9 10

Daytime

Nearly 2/3 of pedestrian crashes occurred between 6 AM and 6 PM.

1 2 3 4 5 6
7 8 9 10

Improper Turning

"Improper Turning" was cited as the primary violation in nearly half of bike crashes.

1 2 3 4 5 6
7 8 9 10

BICYCLE

Sideswipe

45% of bicycle crashes were sideswipe.

1 2 3 4 5 6
7 8 9 10

Improper Turning

"Improper Turning" was cited as the primary violation in nearly half of bike crashes.

1 2 3 4 5 6
7 8 9 10

1 Numbers that are turned on represent a location where crash type has occurred at least three times.

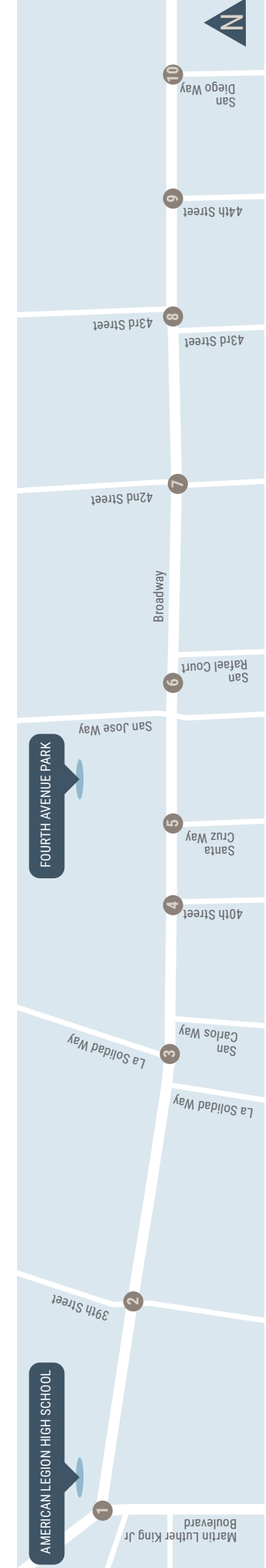
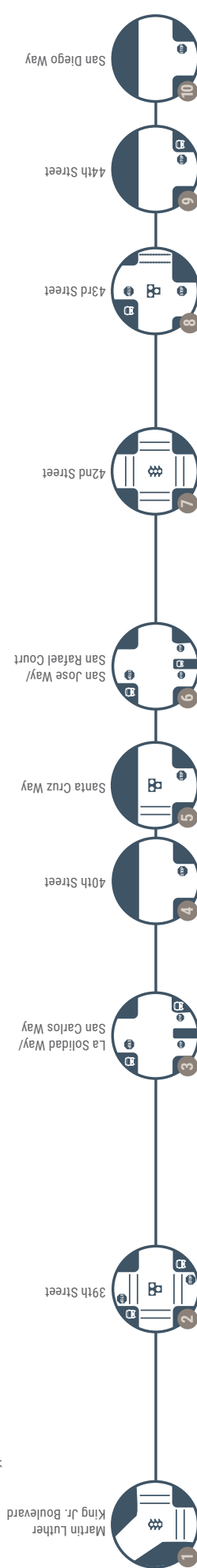

FIGURE 16

STOCKTON BOULEVARD CRASHES



CORRIDOR CRASH SUMMARY (2009-2017)

	47		5		13
FATAL AND SEVERE CRASHES	2	3	2		

KEY CHARACTERISTICS

- Four travel lanes plus raised median/center turn lane.
- Class II bicycle lanes along entire corridor.

SPEED LIMIT
35

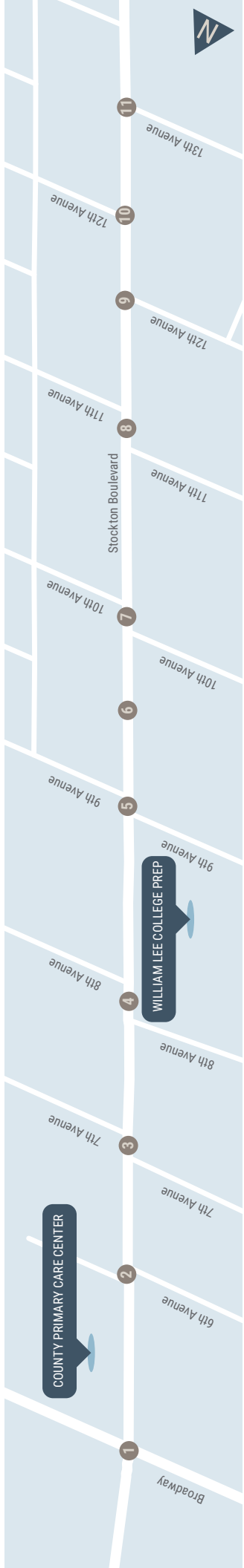
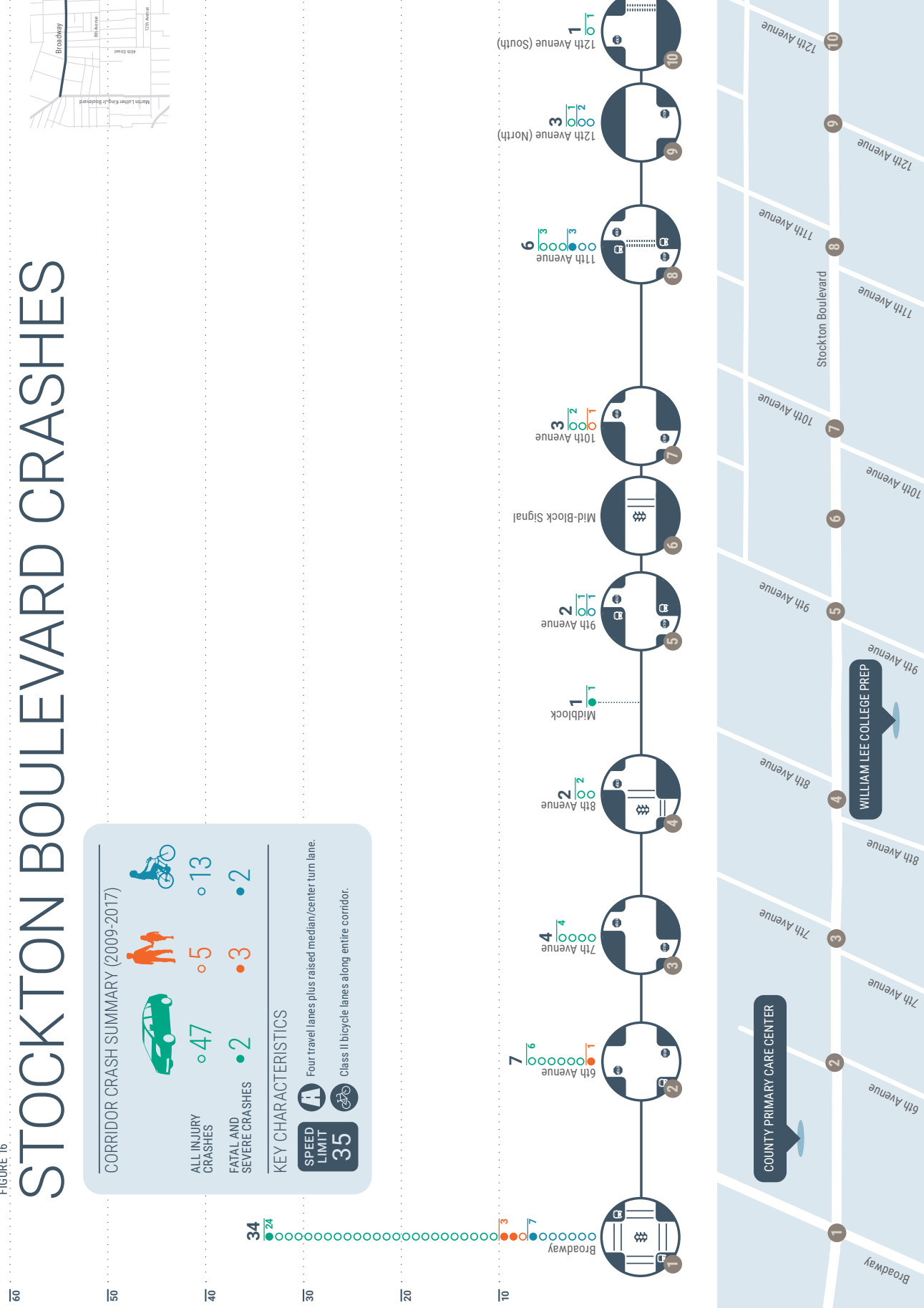



FIGURE 17

CORRIDOR-WIDE CRASH TYPES

VEHICLE

Unsafe Speed



"Unsafe Speed" was the primary violation cited in 23% of all crashes.

1 2 3 4 5 6
7 8 9 10 11

Proceeding Straight



More than 60% of drivers were proceeding straight or stopped at the time of the crash.

1 2 3 4 5 6
7 8 9 10 11

Broadside



40% of all crashes were broadside, also called T-Bone.

1 2 3 4 5 6
7 8 9 10 11

Crossing in Crosswalk



60% of pedestrians hit by drivers were crossing in a crosswalk at the time of the crash.

1 2 3 4 5 6
7 8 9 10 11

Rear End



Rear End was the second most common crash type - 20% of all crashes.

1 2 3 4 5 6
7 8 9 10 11

Left Turns



More than 70% of drivers who were turning at the time of the crash were making a left turn.

1 2 3 4 5 6
7 8 9 10 11

Senior Victims



60% of pedestrian victims were age 60 or older.

1 2 3 4 5 6
7 8 9 10 11

BICYCLE

Broadside



More than 60% of bicycle crashes were broadside, also called T-Bone.

1 2 3 4 5 6
7 8 9 10 11

Morning



More than 60% of bicycle crashes occurred before noon.

1 2 3 4 5 6
7 8 9 10 11

Right Turns



In nearly half of bike crashes, the driver was making a right turn.

1 2 3 4 5 6
7 8 9 10 11

1 Numbers that are turned on represent a location where crash type has occurred at least three times.

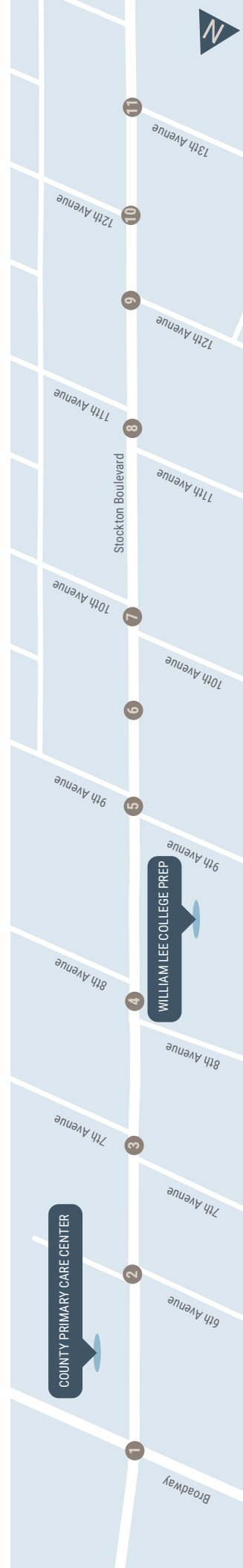
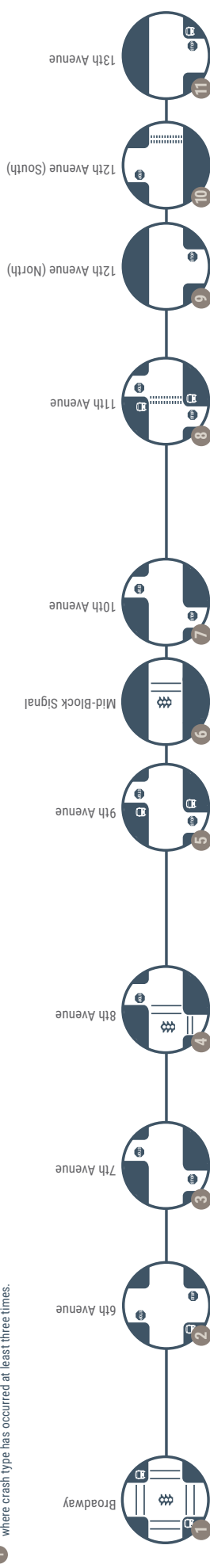



El Camino Avenue

Existing Conditions

The Top Five segment of El Camino Avenue is located between the paved crossing for Steelhead Creek trail and Del Paso Boulevard. The intersection and roadway counts for this segment were collected May 24, 2018. The observed AM peak hour occurred between 7:30 and 8:30 am with PHF of 0.91 and heavy vehicle percentage of two. The PM peak hour occurred from 5:00 to 6:00 PM with a PHF of 0.97 and heavy vehicle percentage of one. During the peak hours, there was a minimum of two bicyclists traveling through each study intersection and three pedestrians crossing at each study intersection on the corridor. The observed ADT on El Camino Avenue is 13,500 vehicles.

The travel patterns are shown in Figure 18. Figure 19 summarizes the existing conditions for this corridor.

Vehicular Facilities

This segment has two travel lanes with a posted speed limit of 30 miles per hour. The City of Sacramento's General Plan 2035 classifies this segment as an arterial, and Policy M1.2.2 exempts this road from the LOS D standard that is applied to most roadways in the City. Instead, LOS E is allowed because expansion of the roadway would cause undesirable impacts or conflict with other community values.

There are two five-legged intersections on this segment, an unsignalized side-street stop-controlled intersection at El Camino Avenue/Altos Avenue/Hawthorne Avenue, and a signalized intersection at El Camino Avenue/Del Paso Boulevard/Beaumont Street. The south leg of the El Camino Avenue/Altos Avenue/Hawthorne Avenue is not paved and carries minimal volume. Beaumont Street provides one-way travel in the southbound direction from El Camino Avenue/Del Paso Boulevard, and therefore is an approach with receiving lanes only.

Parking is prohibited for the entire segment of El Camino Avenue. The land use on this street is primarily residential (single-family dwelling units), and vehicles must park in garages or on driveways.

FIGURE 19

EL CAMINO AVENUE - EXISTING CONDITIONS

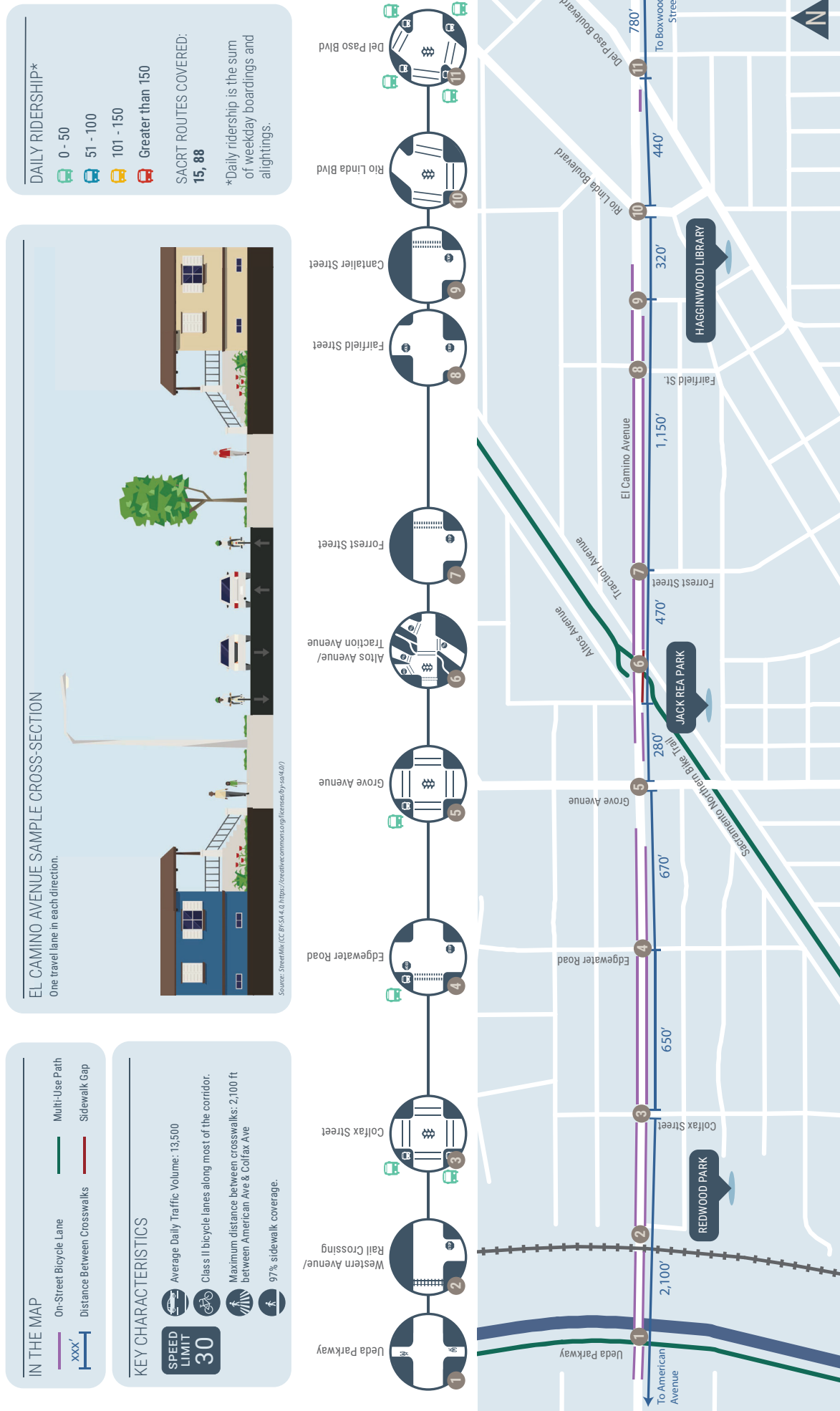

Table 8 summarizes the SimTraffic operations analysis results. Appendix B contains detailed calculations of these results.

Table 8: Peak Hour Intersection Operations – El Camino Avenue

Intersection	Traffic Control ¹	AM Peak Hour		PM Peak Hour	
		Delay ² (s)	LOS ³	Delay ² (s)	LOS ³
Colfax Street/El Camino Avenue	Signal	3.7	A	6.7	A
Grove Avenue/El Camino Avenue	Signal	24.2	C	56.5	E
Altos Avenue/El Camino Avenue/Hawthorne Avenue	SSSC	6.8 (39.9) (SW LT)	A (E)	28.2 (77.1) (SW RT)	D (F)
Forrest Street/El Camino Avenue	SSSC	1.4 (4.9) (WB LT)	A (A)	6.3 (45.7) (NB LT)	A (E)
Cantalier Street/El Camino Avenue	SSSC	1.0 (4.1) (NB RT)	A (A)	1.8 (9.5) (NB LT)	A (A)
Rio Linda Boulevard/El Camino Avenue	Signal	6.8	A	10.8	B
Del Paso Boulevard/Beaumont Street/El Camino Avenue	Signal	25.5	C	36.7	D

Notes:

1. Signal = traffic signal-controlled intersection; SSSC = side-street stop-controlled intersection
2. Average control delay for signalized intersections is the weighted average for all movements. For SSSC intersections, the delay and LOS for the highest delay movement is shown in parentheses.
3. LOS = level of service; calculated based on methodologies contained in the *Highway Capacity Manual, 6th Edition* (Transportation Research Board, 2016).

Bold text indicates unacceptable operations.

Source: Fehr & Peers, 2018.

As shown in Table 8, the overall delays and LOS for all intersections are acceptable during peak hour conditions. However, the El Camino Avenue/Grove Avenue intersection operations have substantial queue spillback in both the eastbound and westbound direction during the peak hour. The westbound queue extends to between Forrest Street and Cantalier Street and results in long delays at the side street movements of Altos Avenue/Hawthorne Avenue and Forrest Street.

Figure 20: Del Paso Boulevard/Beaumont Street/El Camino Avenue Intersection



Transit Facilities

Sacramento Regional Transit's Line 88 operates on the west side of this segment of El Camino Avenue between the Steelhead Creek trail crossing and Grove Avenue. This line serves the Arden/Del Paso area and downtown Sacramento and operates from 5:30 AM to 9:00 PM on weekdays with hour-long headways. On Saturdays, the line operates from 6:00 AM to 9:30 PM and on Sundays and holidays it operates from 8:00 AM to 9:00 PM. The stops for this line on this segment are marked with signage only and do not have transit shelters.

Additionally, Line 15 operates on Del Paso Boulevard with stops at the Del Paso Boulevard/El Camino Avenue intersection in both directions.

Pedestrian Facilities

For most of the segment, there are five-foot sidewalks on both sides of the street with a landscape buffer. There is a gap in the sidewalk on the south side of the road between Altos Avenue and Traction Avenue, and there is no landscape buffer between Rio Linda Boulevard and Del Paso Boulevard. Lighting is provided by overhead roadway lighting for the entire segment and pedestrian-scale lighting exists on portions of the segment.

Crosswalks across El Camino Avenue are striped at all signalized intersections along the corridor. There is no crosswalk on the east leg of the El Camino Avenue/Del Paso Boulevard/Beaumont Street intersection. It should be noted that frequent jaywalking occurred at this location during field observations. Striped

crosswalks also exist at a few side-street stop-controlled intersections: Edgewater Road, Altos Avenue/Hawthorne Avenue, Forrest Street, and Cantalier Street. The maximum crossing distance within the segment is 1,150 feet between Forrest Street and Cantalier Street. Beyond the extents of this segment, the distance west of Colfax Street (the westernmost marked crosswalk on the study corridor) to the next nearest crossing is 2,100 feet at American Avenue.

El Camino Avenue intersects with two separated, multi-use paths. The westernmost intersection of the segment is the El Camino Avenue/Steelhead Creek trail intersection. Additionally, El Camino Avenue intersects with the Sacramento Northern Bike Trail between the intersections at Altos Avenue/Hawthorne Avenue and Traction Avenue. This intersection has a paved crossing with a traffic signal that stops eastbound and westbound traffic when a cyclist or pedestrian activates the crossing phase.

Most crosswalks on this corridor feature basic markings with solid lines. The crosswalks at the Sacramento Northern Bike Trail crossing and on the east leg of the Cantalier Street intersection feature a triple-four configuration.

Bicycle Facilities

There are Class II bike lanes on the majority of the segment, with gaps near Grove Avenue and between Cantalier Street and Del Paso Boulevard. The marked bike lanes are in an oversized gutter pan of the road, directly adjacent to the rolled curb, and are often blocked by trash cans, leaf piles, etc. Additionally, the bike lanes are around four feet in width, and the concrete quality is poor. The flow line of the gutter pan is around one foot from the edge of the curb. During field observations, many cyclists traveled on the sidewalk instead of using the bike lanes. Figure 21 shows the bike lanes on El Camino Avenue.

Figure 21: Bike Lanes on El Camino Avenue



Figure 22: El Camino Avenue/Altos Avenue Intersection



StreetScore+

Because there is no raised median on El Camino Avenue, the majority of segments have a rating of 3 for their bicycle facilities. This means that bicyclists considered “enthused and confident” will tolerate the stress of the segment. Additionally, the sidewalk width is less than six feet, and the distance between crosswalks is greater than 400 feet, so many segments have a pedestrian score of 3 and 4, which indicates that either walking is uninviting and uncomfortable or walking is very uncomfortable and even impossible. Table 9 shows the StreetScore+ of El Camino Avenue segments. Appendix B of this report includes detailed calculations of these results.

Table 9: StreetScore+ Results – El Camino Avenue

Segment	Direction	Bicycle StreetScore+	Pedestrian StreetScore+
El Camino Avenue between Rail Crossing and Western Avenue	EB	3	4
	WB	3	3
El Camino Avenue between Western Avenue and Colfax Street	EB	3	3
	WB	3	3
El Camino Avenue between Colfax Street and Edgewater Road	EB	3	3
	WB	3	3
El Camino Avenue between Edgewater Road to Grove Avenue	EB	3	3
	WB	3	3
El Camino Avenue between Grove Avenue and Altos Avenue/Hawthorne Street	EB	3	3
	WB	3	3
	EB	3	3



Table 9: StreetScore+ Results – El Camino Avenue

Segment	Direction	Bicycle StreetScore+	Pedestrian StreetScore+
El Camino Avenue between Altos Avenue/Hawthorne Street and Forrest Street	WB	3	4
El Camino Avenue between Forrest Street and Fairfield Street	EB	3	3
	WB	3	3
El Camino Avenue between Fairfield Street and Cantalier Street	EB	3	3
	WB	3	3
El Camino Avenue between Cantalier Street and Rio Linda Boulevard	EB	2	4
	WB	3	3
El Camino Avenue between Rio Linda Boulevard and Del Paso Boulevard	EB	2	3
	WB	4	3
El Camino Avenue between Del Paso Boulevard and Empress Street	EB	4	3
	WB	3	3

StreetScore+ ratings range from 1 through 4 with 1 representing low stress bicycle and pedestrian travel conditions and 4 representing high stress bicycle and pedestrian travel conditions.
Source: Fehr & Peers, 2018.

Collision Analysis

The crash locations along El Camino Avenue are shown in Figure 23. Figure 24 summarizes the crash types along the corridor. These figures also served as display boards at outreach events.

Along the El Camino Avenue corridor, the most crashes occurred at the Del Paso Boulevard (20 crashes), and Altos Avenue/Traction Avenue (19 crashes) intersections. There was one KSI crash at each location, including a pedestrian KSI crash at Altos Avenue/Traction Avenue. Other pedestrian KSI crashes occurred at the Fairfield Street intersection, and at the midblock location between Western Avenue and Colfax Street.

FIGURE 23

EL CAMINO AVENUE CRASHES

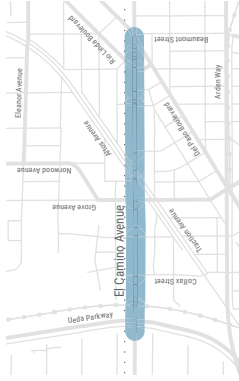

CORRIDOR CRASH SUMMARY (2009-2017)

	117		16		11
FATAL AND SEVERE CRASHES	8	3	0		

*One crash involved both a pedestrian and bicyclist, and is identified under both mode categories.

KEY CHARACTERISTICS

- 30** Speed Limit
- One travel lane in each direction.
- Class II bicycle lanes along most of the corridor.

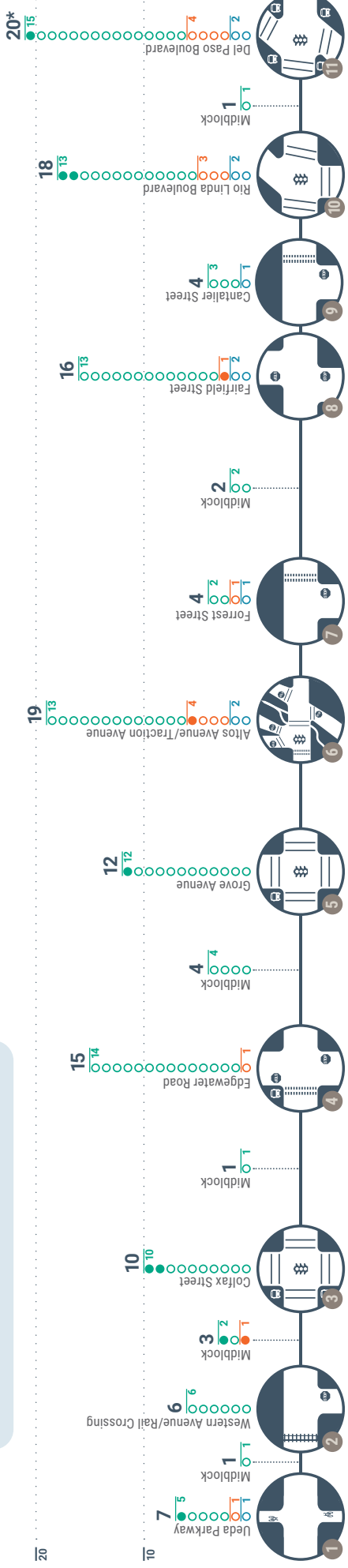

FIGURE 24

CORRIDOR-WIDE CRASH TYPES

VEHICLE

Unsafe Speed

"Unsafe Speed" was the most common violation, cited in 40% of all crashes.

1 2 3 4 5 6
7 8 9 10 11

Proceeding Straight

80% of drivers were proceeding straight or stopped at the time of the crash.

1 2 3 4 5 6
7 8 9 10 11

Signal or Sign Violation

"Traffic Signals and Signs" was the second most common violation category.

1 2 3 4 5 6
7 8 9 10 11

Pedestrian Crossing

The majority of people hit while walking were crossing. 2/3 of people were in the crosswalk.

1 2 3 4 5 6
7 8 9 10 11

Rear End

Over 40% of all crashes were rear end.

1 2 3 4 5 6
7 8 9 10 11

Left Turns

70% of drivers who were turning at the time of the crash were making a left turn.

1 2 3 4 5 6
7 8 9 10 11

Broadside

30% of all crashes were broadside, also called T-Bone.

1 2 3 4 5 6
7 8 9 10 11

Weekend

Nearly 2/3 of pedestrian crashes occurred on Friday, Saturday or Sunday.

1 2 3 4 5 6
7 8 9 10 11

Daytime

10 of 11 total bicycle crashes occurred between 9 AM and 6 PM.

1 2 3 4 5 6
7 8 9 10 11

BICYCLE

1 Numbers that are turned on represent a location where crash type has occurred at least three times.

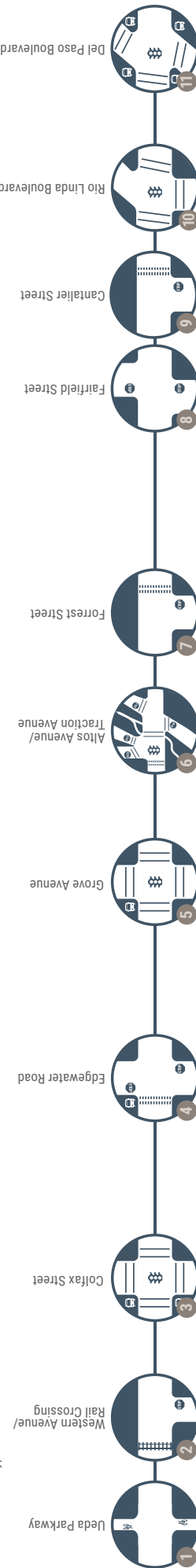

Crashes involving a vehicle proceeding straight or stopped, unsafe speed violations, and rear end crashes were common along El Camino, with at least three crashes of each crash type occurring at almost all intersections. Other common crash types along the corridor include:

- Vehicle left-turns (Colfax Street, Altos Avenue/Traction Avenue, Fairfield Street, Del Paso Boulevard)
- Broadside crashes (Colfax Street, Edgewater Road, Grove Avenue, Altos Avenue/Traction Avenue, Fairfield Street, Rio Linda Boulevard, Del Paso Boulevard)
- Signal or sign violations (Grove Avenue, Fairfield Street, Rio Linda Boulevard, Del Paso Boulevard)
- Pedestrian hit while crossing the street, with most people crossing in a crosswalk (Altos Avenue/Traction Avenue, Rio Linda Boulevard, Del Paso Boulevard)
- Pedestrian crashes on the weekend (Altos Avenue/Traction Avenue, Del Paso Boulevard)

Feedback

Many of the comments received during El Camino Avenue outreach events were regarding visibility and signals/signage. These comments are detailed in the *Community Outreach Report – Phase 1*, which is included in Appendix A.



Florin Road

Existing Conditions

The study segment of Florin Road is between 24th Street and Munson Way. Traffic counts were conducted on May 31, 2018. The observed AM peak hour occurred between 7:30 and 8:30 am with a 0.91-PHF and three percent heavy vehicle count. The observed PM peak hour occurred between 4:30 and 5:30 PM with a 0.95-PHF and two percent heavy vehicle count. During the peak hours, at least four bicyclists traveled through each study intersection and at least six pedestrians crossed the street at each study intersection along the corridor. The ADT observed on Florin Road is 36,000 vehicles.

Figure 25 shows the travel patterns along Florin Road. Figure 26 summarizes existing conditions for this corridor.

Vehicular Facilities

This segment is comprised of four travel lanes plus a raised median and center turn-lane. The Florin Road/Luther Drive intersection is offset, (i.e. the north and south legs are not aligned). The posted speed limit is 40-miles per hour.

The *Sacramento General Plan 2035* designates this segment as an arterial. Policy M.1.2.2 indicates that the City shall strive for LOS D operations on this corridor during typical weekdays including peak hours. Table 10 shows the peak hour intersection delay and level of service. All intersections operate acceptably at LOS D or better. Appendix B includes detailed calculations of these results.

Table 10: Peak Hour Intersection Operations – Florin Road

Intersection	Traffic Control ¹	AM Peak Hour		PM Peak Hour	
		Delay ² (s)	LOS ³	Delay ² (s)	LOS ³
24 th Street/Florin Road	Signal	9.7	A	11.0	B
Woodbine Avenue/Florin Road	Signal	22.6	C	20.2	C
29 th Street/Indian Lane/Florin Road	Signal	13.2	B	4.0	A
Luther Burbank HS/Florin Road	Signal	48.8	D	42.9	D
Luther Drive/Florin Road	Signal	9.7	A	11.0	B
Munson Way/Florin Road	SSSC	2.6 (13.5) (WB LT)	A (B)	2.8 (13.9) (WB LT)	A (B)

Notes:

1. Signal = traffic signal-controlled intersection; SSSC = side-street stop-controlled intersection
2. Average control delay for signalized intersections is the weighted average for all movements. For SSSC intersections, the delay and LOS for the highest delay movement is shown in parentheses.
3. LOS = level of service; calculated based on methodologies contained in the *Highway Capacity Manual, 6th Edition* (Transportation Research Board, 2016).

Source: Fehr & Peers, 2018.

FIGURE 25

FLORIN ROAD TRAVEL PATTERNS

Thursday, May 31st, 2018. 7:30-8:30 AM & 4:30-5:30 PM

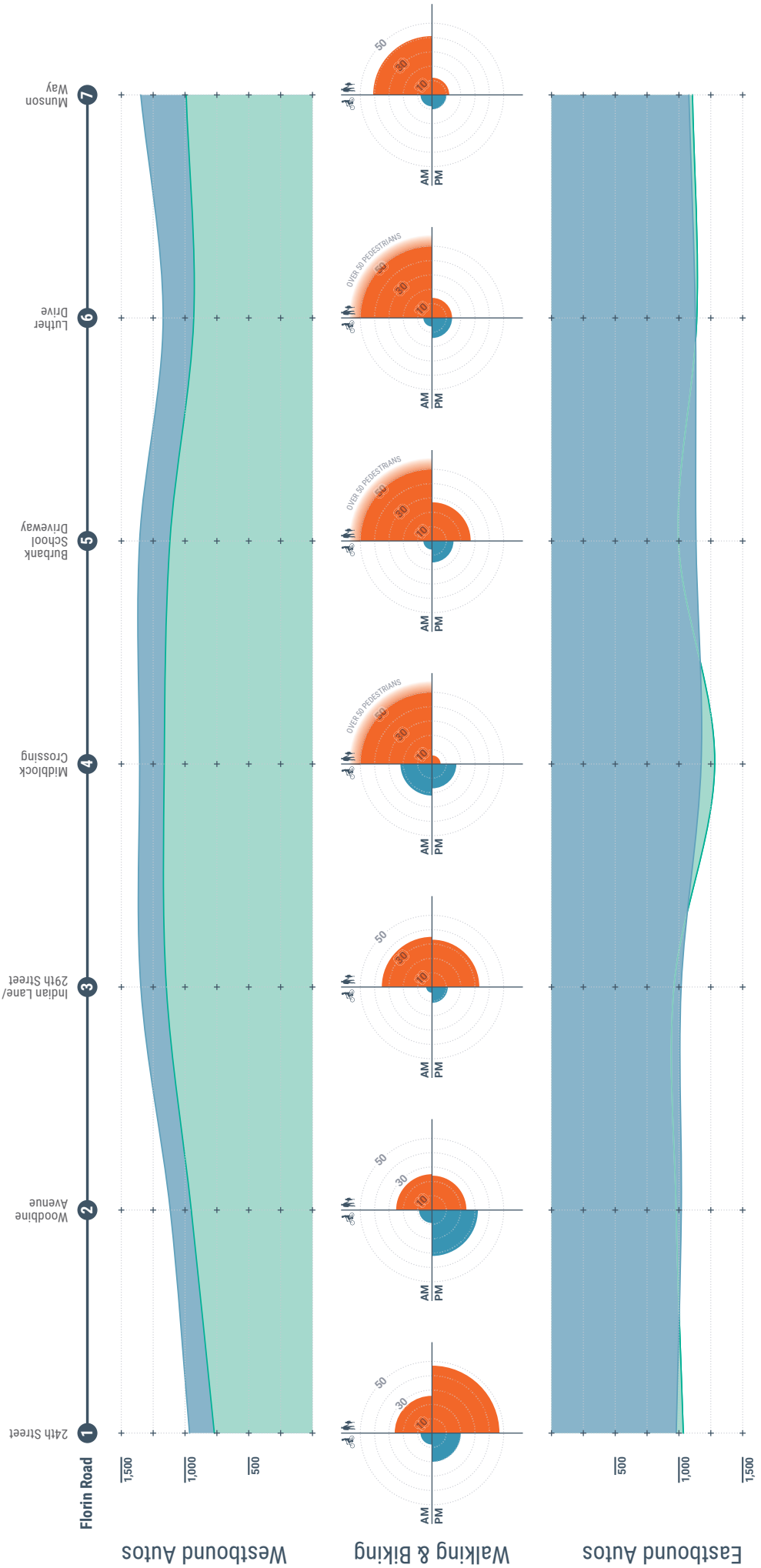
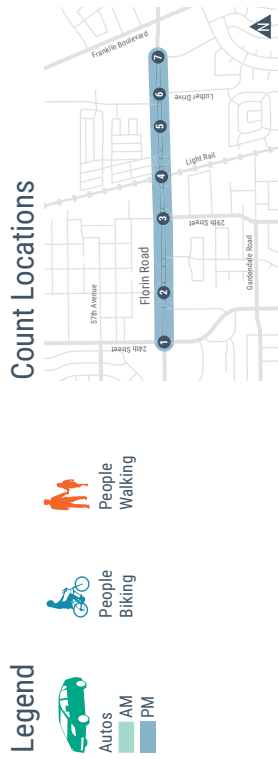
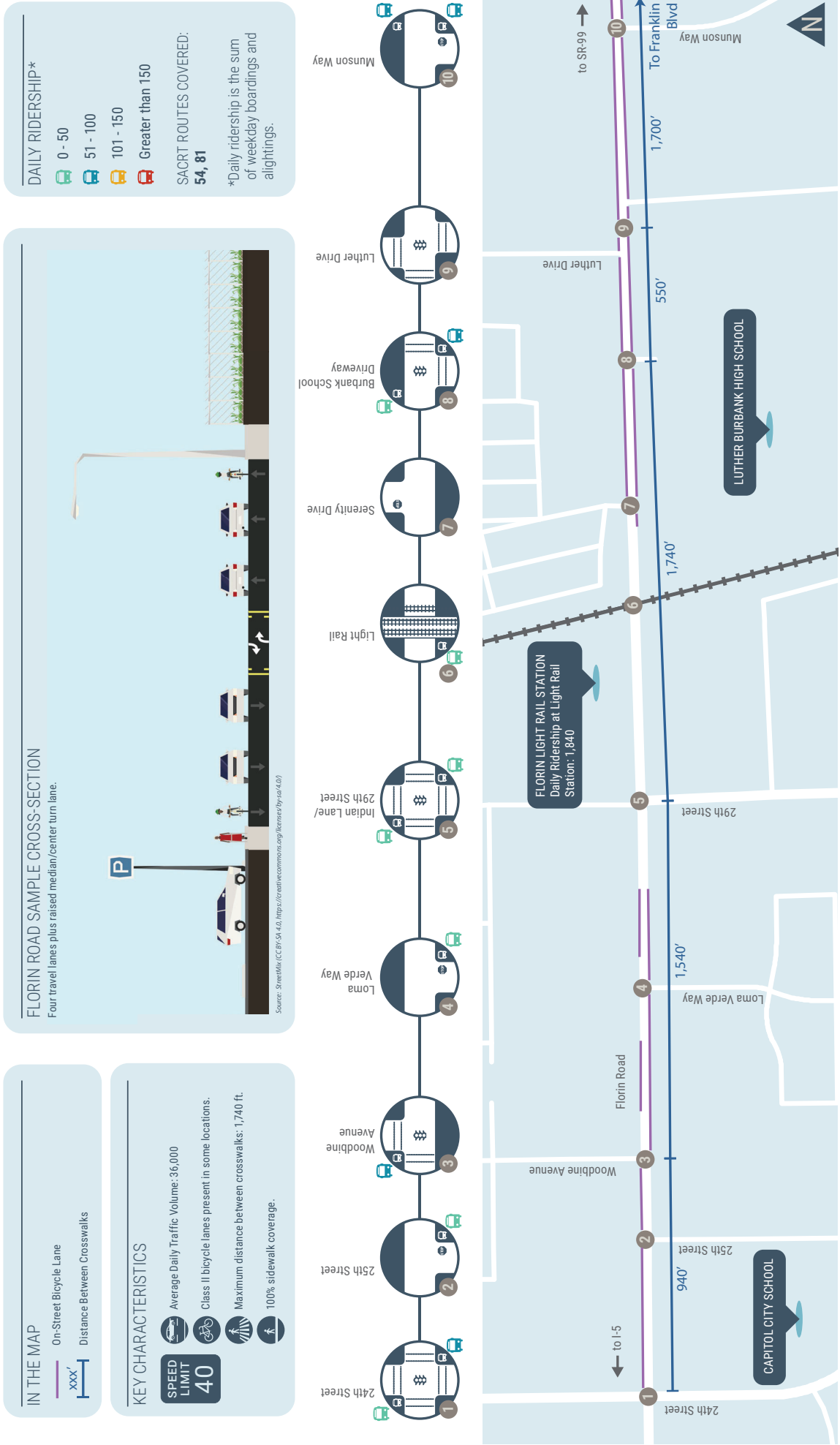

FIGURE 26

FLORIN ROAD - EXISTING CONDITIONS



Transit Facilities

Sacramento Regional Transit operates two bus lines on Florin Road. Line 54 provides service between Gerber Road/Power Inn Road and the Florin Light Rail station. It has hour-long headways and operates between 5:30 AM and 8:00 PM on weekdays. On Saturdays, the line only operates between Cosumnes River College and Florin Light Rail Station between 8:30 AM and 8:00 PM. There is no service on Sundays and holidays.

Line 81 also operates on Florin Road with 15-minute headways between Florin Road/Riverside Boulevard and University Avenue/65th Street Light Rail Station. Weekday service starts at 5:00 AM and ends at 10:30 PM, Saturday service starts at 6:00 AM and ends at 10:30 PM, and Sunday/holiday service starts at 6:00 AM and ends at 9:00 PM.

There are transit shelters for the eastbound stop Luther Drive/Florin Road (in front of Luther Burbank High School), the westbound stop at 29th Street/Indian Lane/Florin Road, the westbound stop at Florin Road/Woodbine Avenue, and the westbound stop at Florin Road/24th Street. Additionally, there are benches for the westbound bus stop at Serenity Drive/Florin Road and the eastbound stop at 25th Street/Florin Road.

The Florin Road Light Rail Station is located between the 29th Street/Indian Lane/Florin Road and Serenity Drive/Florin Road intersections and is part of the Blue Line of Sacramento Regional Transit's light rail network. This line has 15-minute headways during peak periods and 30-minute headways during non-peak periods. The Blue Line connects Cosumnes River College to the Watt Avenue/I-80 transit station. On weekdays it operates from 4:00 AM to midnight, on Saturdays it operates from 4:30 AM to midnight, and on Sundays and holidays it operates from 5:00 AM to 10:00 PM.

Figure 27: Florin Road and Light Rail Overcrossing



Pedestrian Facilities

There are sidewalks on both sides of the street with widths varying between five and six feet. The sidewalk is adjacent to the bike lane or road shoulder. Lighting is provided by overhead roadway lighting.

There are marked crosswalks across Florin Road at every signalized intersection, though the east leg of the Woodbine Avenue intersection, west leg of Luther Burbank High School Driveway intersection, and east leg of the Luther Drive intersection do not have striped crosswalks and associated pedestrian phases. None of the side-street stop-controlled intersections on this corridor have striped crosswalks. All crosswalks on this corridor are striped with the basic treatment of solid lines.

Field observations, community feedback and measured data indicate substantial numbers of pedestrians jaywalking midblock under the light rail overpass. Most crossings occur between 7:30 and 8:15 AM, coinciding with the start of classes at Luther Burbank High School at 8:10 AM. It should be noted that measured pedestrian activity at this location drops off sharply during the PM peak hour since the end of the school day occurs prior to the evening commute.

Figure 28: Florin Road



Bicycle Facilities

There are Class II bike lanes present on the north side of Florin Road between 24th Street and Woodbine Avenue, on both sides of the street between Woodbine Avenue and east of Loma Verde Way (though the north side has gaps), and on the both sides of the street on Serenity Drive to east of Munson Way. The bike lane widths vary between 4.5 and six feet.

Some intersections have right-turn lanes, which can present conflicts between right-turning vehicles and cyclists using the bike lanes. However, bike lanes typically remain unblocked by parked vehicles, trash cans, leaf piles, etc.

StreetScore+

The bicycle and pedestrian StreetScore+ of the Florin Road segments are shown in Table 11. Because of the relatively high posted speed, the segments all have a bicycle and pedestrian score 4, meaning that only “strong and fearless” bicyclist will tolerate the stress on the segment and walking is very uncomfortable or even impossible.

Table 11: StreetScore+ Results – Florin Road

Segment	Direction	Bicycle StreetScore+	Pedestrian StreetScore+
Florin Road between Tamoshanter Way and 24 th Street	EB	4	4
	WB	4	4
Florin Road between 24 th Street and 25 th Street	EB	4	4
	WB	4	4
Florin Road between 25 th Street and Woodbine Avenue	EB	4	4
	WB	4	4
Florin Road between Woodbine Avenue and Loma Verde Way	EB	4	4
	WB	4	4
Florin Road between Loma Verde Way and Indian Lane/29 th Street	EB	4	4
	WB	4	4
Florin Road between Indian Lane/29 th Street and LRT	EB	4	4
	WB	4	4
Florin Road between LRT and Serenity Drive	EB	4	4
	WB	4	4
Florin Road between Serenity Drive and Luther Burbank High School Driveway	EB	4	4
	WB	4	4
Florin Road between Luther Burbank High School and Luther Drive	EB	4	4
	WB	4	4
Florin Road between Luther Drive and Munson Way	EB	4	4
	WB	4	4

StreetScore+ ratings range from 1 through 4 with 1 representing low stress bicycle and pedestrian travel conditions and 4 representing high stress bicycle and pedestrian travel conditions.
Source: Fehr & Peers, 2018.



Collision Analysis

Florin Road crashes are shown in Figure 29. Figure 30 summarizes the different crash types along the corridor. These figures also served as display boards at the Florin Road community workshop.

Along the Florin corridor, the most crashes occurred at the 24th Street (58 crashes), Indian Lane/29th Street (37 crashes), Luther Drive (37 crashes), and Munson Way (25 crashes) intersections. One vehicle KSI crash occurred at both the 24th Street and Luther Drive intersections. Three KSI crashes occurred at Munson Way, including one bicycle KSI crash. At Indian Lane/29th Street, there were five KSI crashes, including three pedestrian KSI crashes (accounting for half of the pedestrian KSI crashes along the whole corridor), and one bicycle KSI crash. One pedestrian KSI crash occurred at 25th Street, the light rail crossing, and at the midblock location between Woodbine Avenue and Loma Verde Way.

Crashes involving a vehicle proceeding straight or stopped, unsafe speed violations, and rear end crashes were very common along Florin Road, with at least three crashes of each crash type occurring at almost all intersections. Other common crash types along the corridor include:

- Pedestrians crossing the street (24th Street, 25th Street, 29th Street, Luther Drive)
- Pedestrian victims age 60 or older (24th Street)
- Pedestrian crashes during the winter months (25th Street)
- Bicycle crashes involving a “Wrong Side of the Road” violation (25th Street)
- Broadside bicycle crashes (25th Street, Munson Way)
- Bicycle crashes involving a right-turning vehicle (25th Street, Loma Verde Way)

Feedback

Most of the comments received during outreach for this corridor mentioned enforcement and crossings. These comments are detailed in the *Community Outreach Report – Phase 1*, which is included in Appendix A.

FIGURE 29

FLORIN ROAD CRASHES

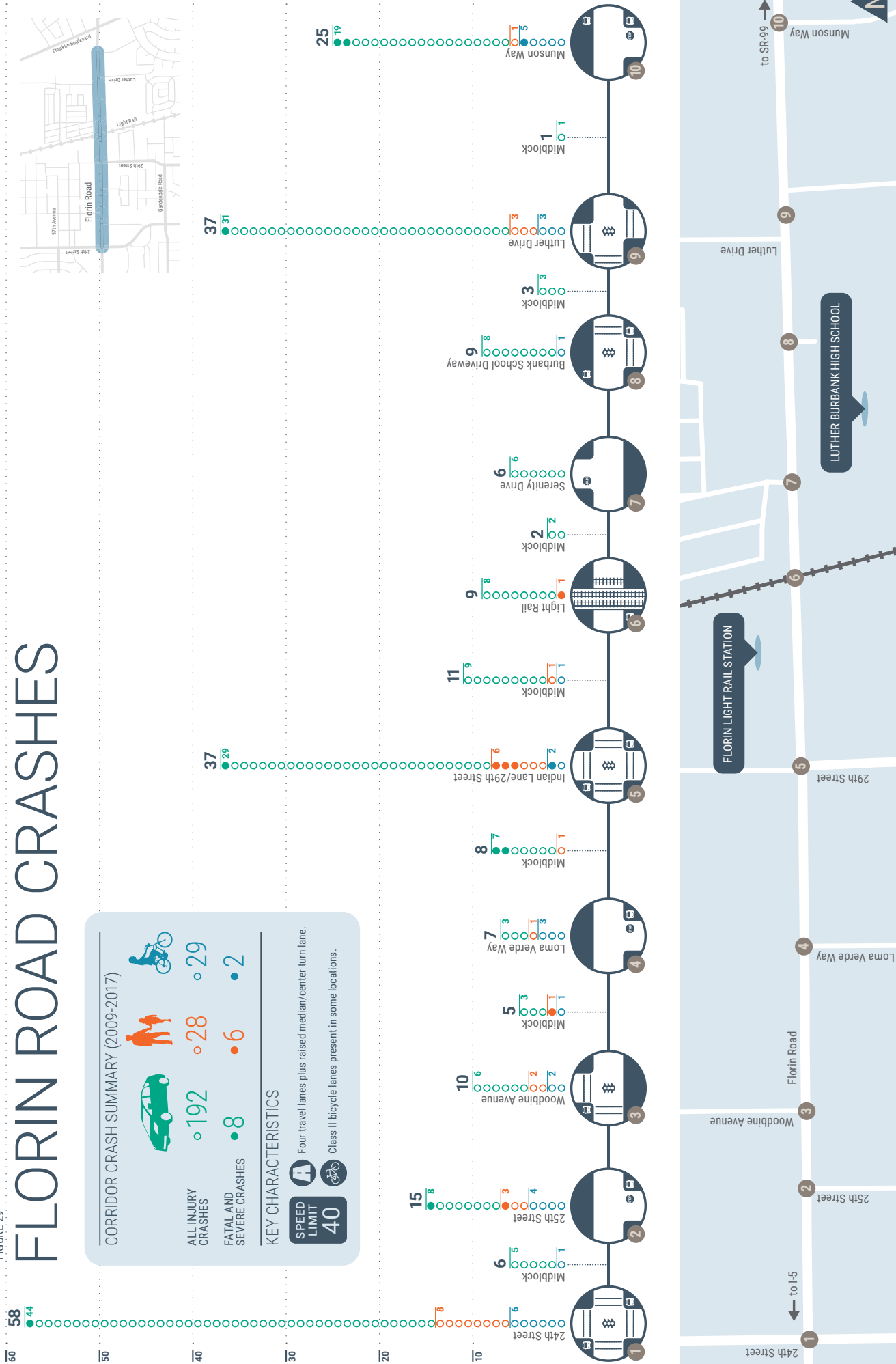

FIGURE 30

CORRIDOR-WIDE CRASH TYPES

VEHICLE

Unsafe Speed

"Unsafe Speed" was cited as the primary violation in nearly half of all crashes.

1 2 3 4 5 6
7 8 9 10

Proceeding Straight

75% of drivers were proceeding straight or stopped at the time of the crash.

1 2 3 4 5 6
7 8 9 10

Pedestrian Crossing

The majority of people hit while walking were crossing. Half of people were in the crosswalk.

1 2 3 4 5 6
7 8 9 10

Winter Crashes

Over 40% of pedestrian crashes occurred in November, December or January.

1 2 3 4 5 6
7 8 9 10

BICYCLE

Wrong Way Riding

The primary violation cited in over 40% of bicycle crashes was "Wrong Side of Road."

1 2 3 4 5 6
7 8 9 10

Broadside

More than half of bicycle crashes were broadside, also called T-Bone.

1 2 3 4 5 6
7 8 9 10

Rear End

Nearly half of all crashes were rear end.

1 2 3 4 5 6
7 8 9 10

Senior Victims

10 of the 28 people hit while walking were age 60 or older.

1 2 3 4 5 6
7 8 9 10

Right Turns

In nearly 40% of bike crashes, the driver was making a right turn.

1 2 3 4 5 6
7 8 9 10

1 Numbers that are turned on represent a location where crash type has occurred at least three times.

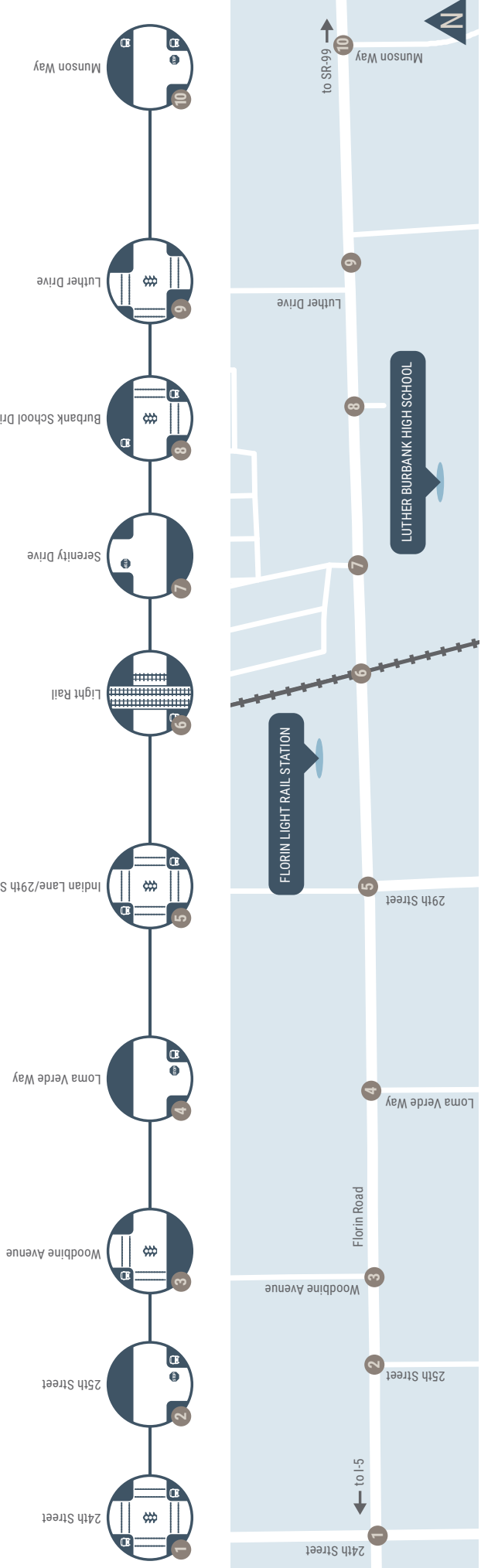

Marysville Boulevard

Existing Conditions

The Top Five segment on Marysville Boulevard is located between North Avenue and Arcade Boulevard. Counts for this segment were collected May 30, 2018. The peak hours of travel along this corridor are 7:15 to 8:15 AM and 5:00 to 6:00 PM. The percentage of heavy vehicles is 4 percent and 2 percent for the AM and PM peak hours, respectively. The measured PHF is 0.93 for the AM peak hour and 0.96 for the PM peak hour. During the peak hours, at least two bicycles traveled through each study intersection, and at least six pedestrians crossed the street at each study intersection. Marysville Boulevard has a daily traffic volume of 26,300 vehicles.

Figure 31 shows the travel patterns of this corridor during peak hours. Figure 32 summarizes the existing conditions of this corridor.

Vehicular Facilities

The Marysville Boulevard segment is four travel lanes. The City of Sacramento's *General Plan 2035* classifies this segment as an arterial. Policy M1.2.1 indicates that the City should strive to operate this road at LOS D or better during typical weekday conditions, including the AM and PM peak hours.

This segment has a raised median/center turn lane and a speed limit of 35 miles per hour. There are sidewalks on both sides of the road for the entire segment, and there are Class II bike lanes on both sides of the road for most of the segment, from I-80 to just north of Ermina Drive. On-street parking is prohibited.

FIGURE 31

MARYSVILLE BOULEVARD TRAVEL PATTERNS

Wednesday, May 30th, 2018. 7:15-8:15 AM & 5:00-6:00 PM

Count Locations



Legend

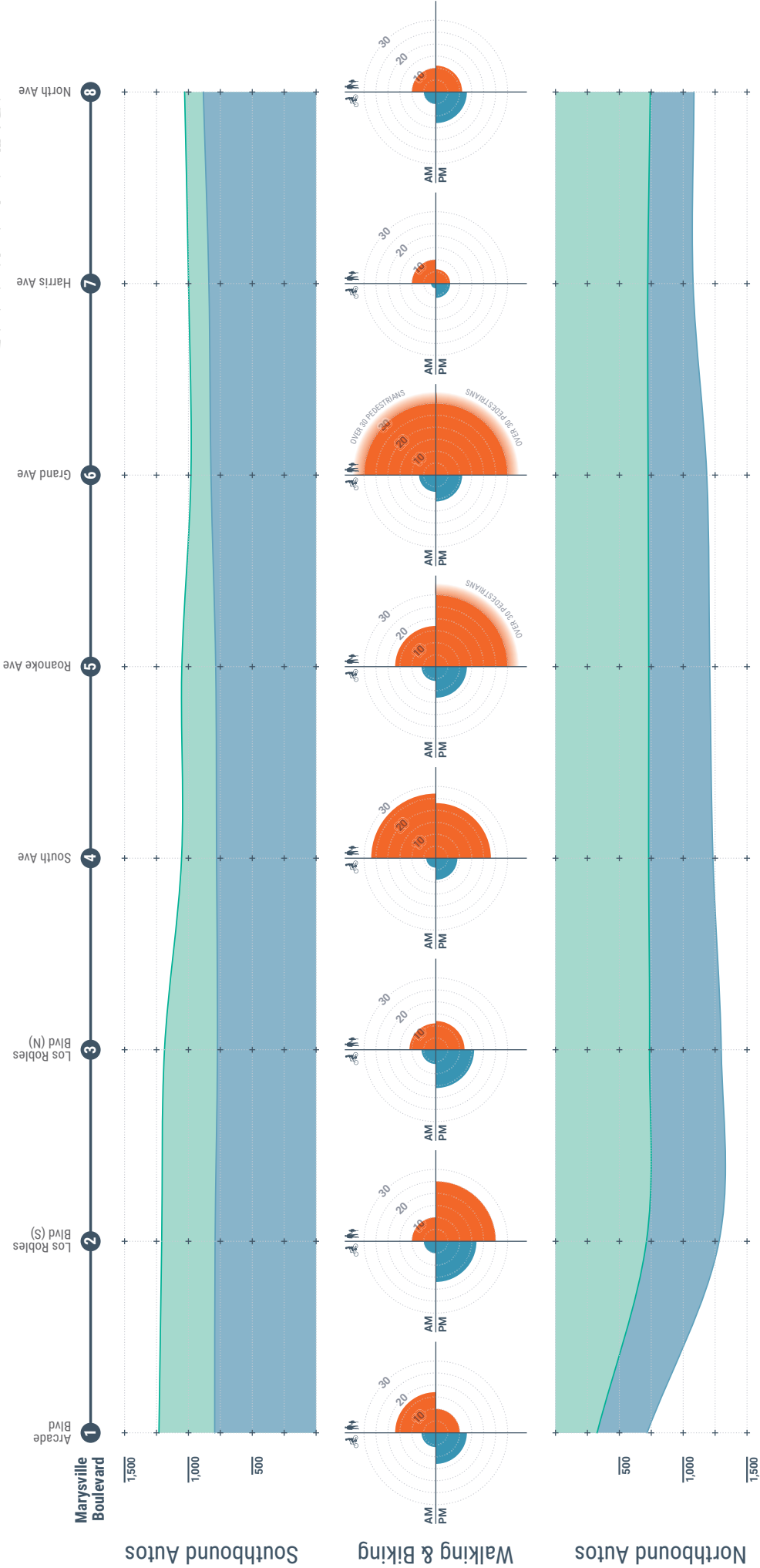

FIGURE 32

MARYSVILLE BOULEVARD EXISTING CONDITIONS

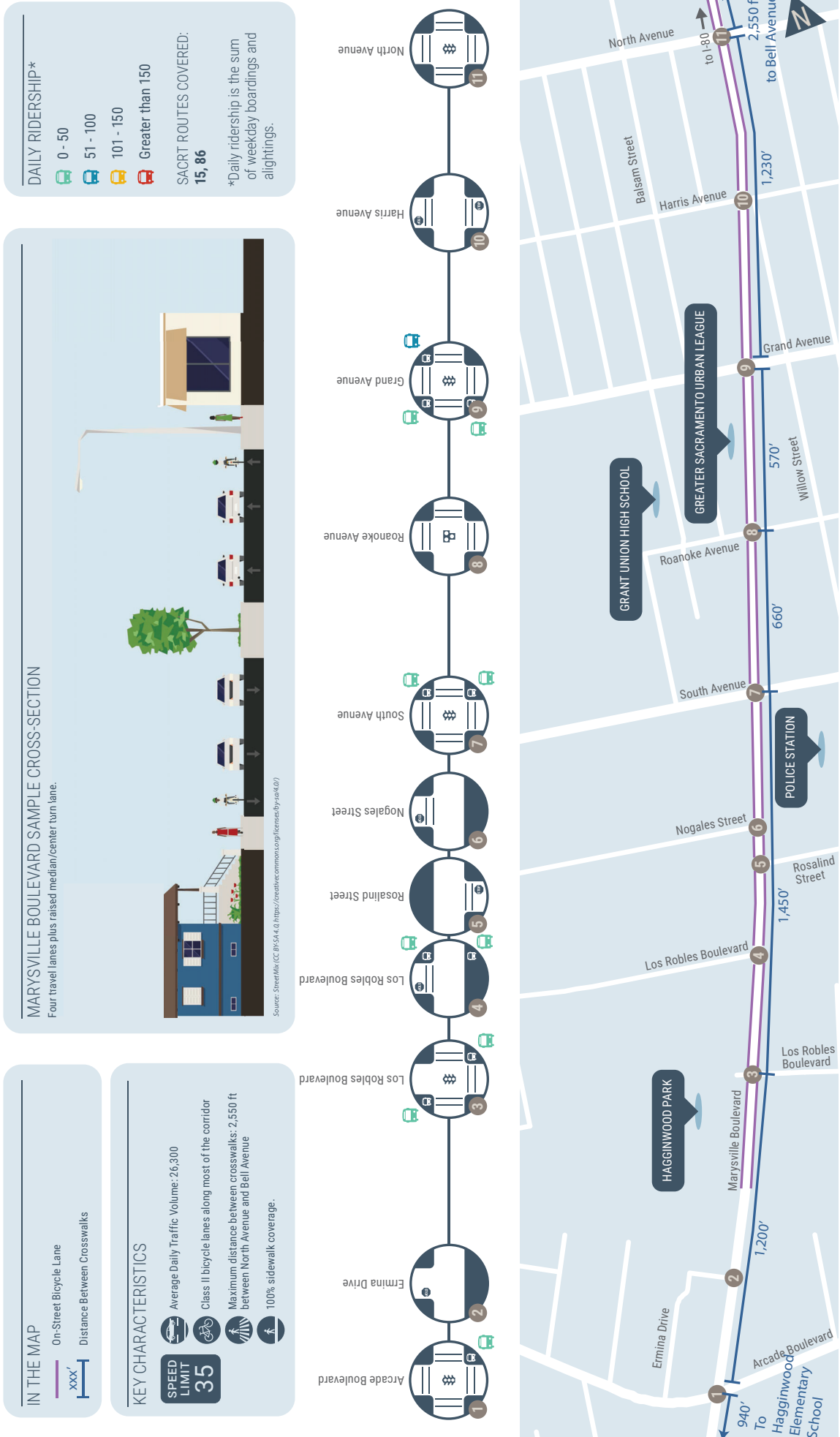

Figure 33: Marysville Boulevard



The results of the SimTraffic analysis are shown in Table 12. All intersections operate acceptably and have an overall LOS of D or better during the AM and PM peak hours. The side-street movements of Marysville Boulevard/Roanoke Avenue (a side-street stop-controlled intersection) experience high delay during the PM peak hour.

Table 12: Peak Hour Intersection Operations – Marysville Boulevard

Intersection	Traffic Control ¹	AM Peak Hour		PM Peak Hour	
		Delay ² (s)	LOS ³	Delay ² (s)	LOS ³
Marysville Boulevard/North Avenue	Signal	9.7	A	10.6	B
Marysville Boulevard/Harris Avenue	SSSC	3.4 (23.4) (EB TH)	A (C)	3.9 (25.3) (EB LT)	A (D)
Marysville Boulevard/Grand Avenue	Signal	20.5	C	19.6	B
Marysville Boulevard/Roanoke Avenue	SSSC	6.1 (15.8) (WB LT)	A (C)	22.3 (68.9) (WB LT)	C (F)
Marysville Boulevard/South Avenue	Signal	14.4	B	10.3	B
Marysville Boulevard/Los Robles Boulevard (North)	SSSC	1.7 (21.6) (EB LT)	A (C)	1.8 (13.0) (EB LT)	A (B)
Marysville Boulevard/Los Robles Boulevard (South)	Signal	4.8	A	6.0	A
Marysville Boulevard/Arcade Boulevard	Signal	30.9	C	42.4	D

Notes:

1. Signal = traffic signal-controlled intersection; SSSC = side-street stop-controlled intersection
2. Average control delay for signalized intersections is the weighted average for all movements. For SSSC intersections, the delay and LOS for the highest delay movement is shown in parentheses.
3. LOS = level of service; calculated based on methodologies contained in the *Highway Capacity Manual, 6th Edition* (Transportation Research Board, 2016).

Bold text indicates unacceptable operations.

Source: Fehr & Peers, 2018.

Transit Facilities

There is one transit line operating on Marysville Boulevard, Line 86 operated by Sacramento Regional Transit. This line serves stops between Marconi Arcade Light Rail station and downtown Sacramento. On weekdays, it has half hour headways between 5:30 AM and 9:15 PM. On Saturdays, the line has hour-long headways between 6:30 AM and 9:00 PM. On Sundays and holidays, Line 86 operates with hour-long headways between 8:00 AM and 6:30 PM.

Line 15 operates on Grand Avenue and has a stop at the Marysville Boulevard/Grand Avenue intersection.

There is a transit shelter at the southbound bus stop at Marysville Boulevard/Los Robles Boulevard (by Hagginwood Park) and a bench for the southbound bus stop at Marysville Boulevard/Los Robles Boulevard (across from Sunshine Academy).

Pedestrian Facilities

Sidewalks line both sides of Marysville Boulevard for the entirety of the segment. The sidewalk widths vary between five and six feet. The sidewalk is in good repair, except for the westside sidewalk north of North Avenue. Lighting is provided by overhead roadway lights. Typically, the sidewalk is adjacent to the bike lane, except for the east side of the road adjacent to the Dollar General store where there is a landscape buffer.

The signalized intersections along the corridor have crosswalks on the north and south legs. The only unsignalized intersection that has a crosswalk across Marysville Boulevard is the Roanoke Avenue intersection. This intersection is side-street stop-controlled and includes a pedestrian hybrid beacon that stops traffic when activated.

Figure 34: Marysville Boulevard/Roanoke Avenue HAWK

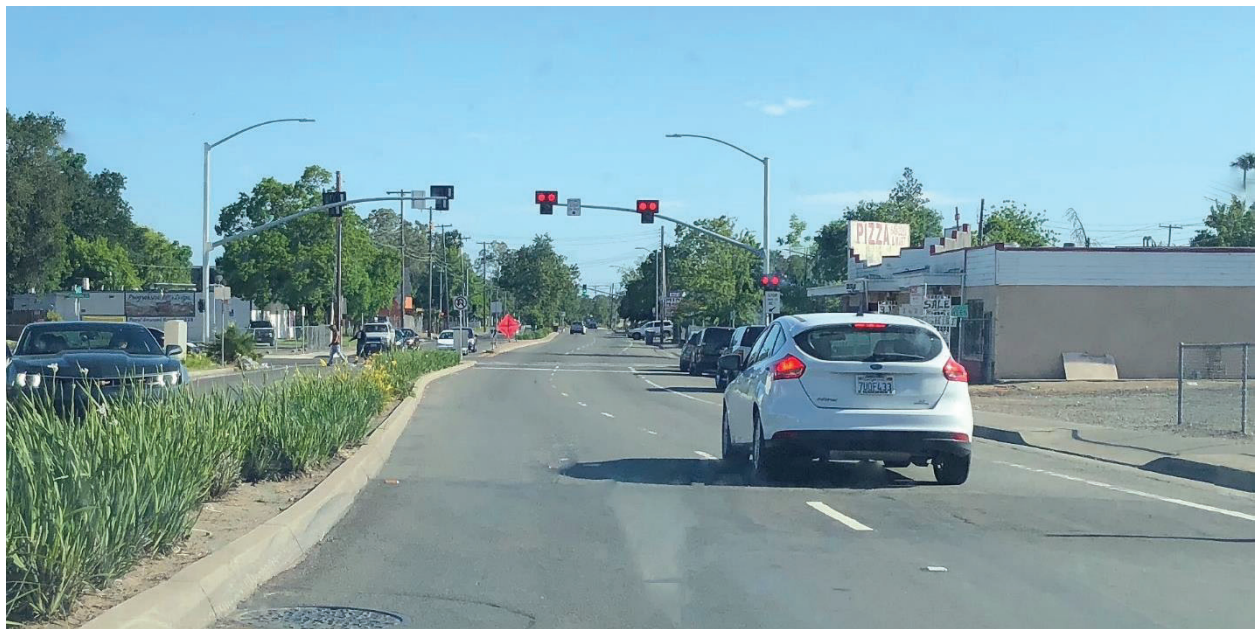

The maximum distance between crosswalks on the segment is 1,230 feet between the north leg of Grand Avenue and the south leg of North Avenue. The crosswalk on the north leg of North Avenue (the northern terminus of the study corridor) is 2,550 feet south of the crosswalk at Bell Avenue, which is outside the segment, north of I-80. All crosswalks on this corridor feature basic markings with solid lines.

Bicycle Facilities

There are Class II bike lanes on both sides of this segment. The width of these bike lanes varies from 3.5 to seven feet. The bike lanes on this segment are between I-80 and the Arcade Creek crossing; there are no bike lanes south of Los Robles Boulevard (South). Bike lanes are typically not blocked by obstructions.

StreetScore+

The StreetScore+ results for study segments along Marysville Boulevard are shown in Table 13. Because Marysville Boulevard has a 35 mile-per-hour posted speed limit and a centerline, many bicycle scores for these roadway segments are 3 and 4, meaning that only “enthused and confident” and “strong and fearless” cyclists will tolerate the stress, respectively. Furthermore, many crosswalks that cross Marysville Boulevard, and the driveways along the roadway have curb cuts, so pedestrian StreetScore+’s are also 3 and 4, which indicates that walking is either uncomfortable or very uncomfortable.

Table 13: StreetScore+ Results – Marysville Boulevard

Segment	Direction	Bicycle StreetScore+	Pedestrian StreetScore+
Marysville Boulevard between Doolittle Street and North Avenue	NB	4	4
	SB	4	4
Marysville Boulevard between North Avenue and Harris Avenue	NB	3	3
	SB	3	3
Marysville Boulevard between Harris Avenue and Grand Avenue	NB	3	3
	SB	3	3
Marysville Boulevard between Grand Avenue and Roanoke Avenue	NB	3	3
	SB	3	3
Marysville Boulevard between Roanoke Avenue and South Avenue	NB	3	3
	SB	3	3
Marysville Boulevard between South Avenue and Nogales Street	NB	3	3
	SB	3	3
Marysville Boulevard between Nogales Street and Rosalind Street	NB	3	4
	SB	3	4
Marysville Boulevard between Rosalind Street and Los Robles Boulevard (N)	NB	3	4
	SB	3	3
Marysville Boulevard between Los Robles Boulevard (N) and Los Robles Boulevard (S)	NB	3	3
	SB	3	3
Marysville Boulevard between Los Robles Boulevard (S) and Ermina Drive	NB	4	3
	SB	4	3
Marysville Boulevard between Ermina Drive and Arcade Boulevard	NB	4	4
	SB	4	3
Marysville Boulevard between Arcade Boulevard and Sonoma Avenue	NB	4	3
	SB	4	4

StreetScore+ ratings range from 1 through 4 with 1 representing low stress bicycle and pedestrian travel conditions and 4 representing high stress bicycle and pedestrian travel conditions.

Source: Fehr & Peers, 2018.



Collision Analysis

Figure 35 shows the crash locations on Marysville Boulevard, and Figure 36 summarizes the crash types. These figures were used as display boards for the Marysville Boulevard outreach events.

Along Marysville Boulevard, the most crashes occurred at the intersections of Los Robles Boulevard (42 crashes), Grand Avenue (37 crashes), Arcade Boulevard (25 crashes), and Roanoke Avenue (23 crashes). Five KSI crashes occurred at Los Robles Boulevard, including four pedestrian KSI crashes. Three pedestrian KSI crashes occurred at Grand Avenue, and two occurred at Roanoke Avenue. An additional pedestrian KSI crash occurred at both Harris Avenue and the midblock location between Grand Avenue and Harris Avenue. Two bicycle KSI crashes occurred at Arcade Boulevard. An additional bicycle KSI crash occurred at the midblock location between Ermina Drive and Los Robles Boulevard.

Crashes involving a vehicle proceeding straight or stopped, unsafe speed violations, and rear end crashes were again common along Marysville Boulevard. Other common crash types along the corridor include:

- Vehicle left turns (Arcade Boulevard, Los Robles Boulevard, South Avenue, Roanoke Avenue, Grand Avenue, Harris Avenue, North Avenue)
- Head on crashes (Arcade Boulevard, Los Robles Boulevard, Grand Avenue, North Avenue)
- Broadside crashes (Arcade Boulevard, Los Robles Boulevard, South Avenue, Roanoke Avenue, Grand Avenue, Harris Avenue, North Avenue)
- Severe or fatal crashes with alcohol involved (Los Robles Boulevard)
- Pedestrian crossing the street, with majority of people in a crosswalk (Los Robles Boulevard, Roanoke Avenue, Grand Avenue)
- Pedestrian crashes at night (Los Robles Boulevard, Roanoke Avenue, Grand Avenue)
- Bicycle broadside crashes (Grand Avenue)

FIGURE 35

MARYSVILLE BOULEVARD CRASHES

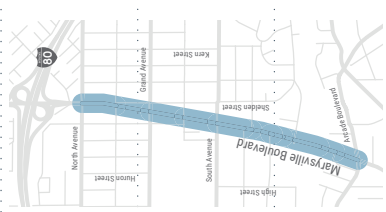

CORRIDOR CRASH SUMMARY (2009-2017)

	148		25		15
FATAL AND SEVERE CRASHES	5	11	3		

KEY CHARACTERISTICS

- SPEED LIMIT 35**
- Four travel lanes plus raised median/center turn lane.
- Class II bicycle lanes along most of the corridor.

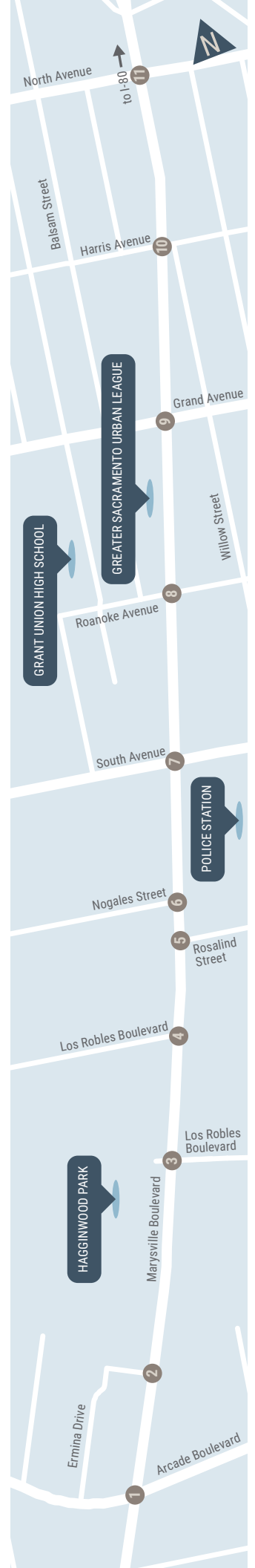
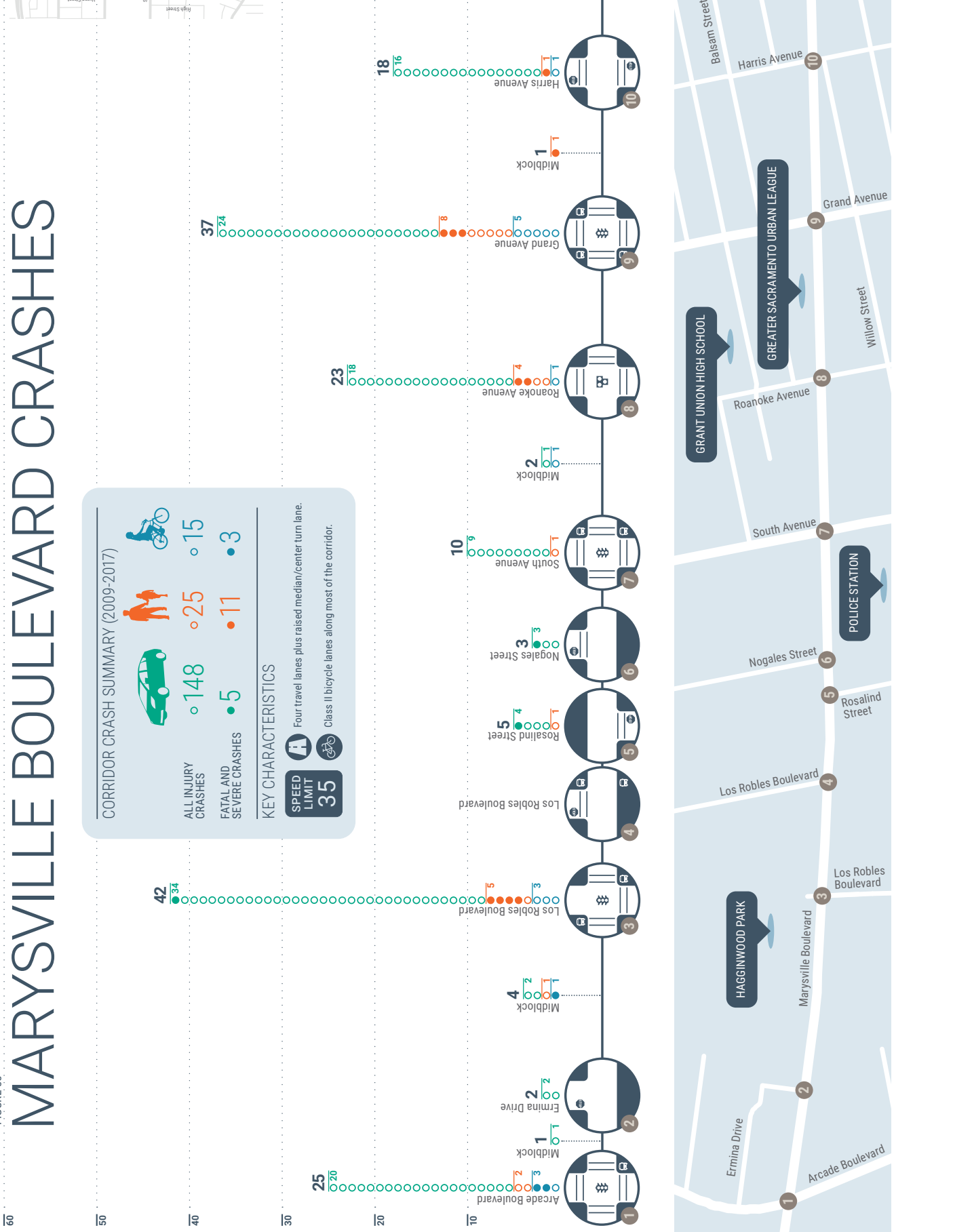

FIGURE 36

CORRIDOR-WIDE CRASH TYPES

VEHICLE

Unsafe Speed
 "Unsafe Speed" was cited as the primary violation in 20% of crashes.

1 2 3 4 5 6
 7 8 9 10 11

Proceeding Straight
 2/3 of drivers were proceeding straight or stopped at the time of the crash.

1 2 3 4 5 6
 7 8 9 10 11

Head On
 Nearly 20% of all crashes were head on.

1 2 3 4 5 6
 7 8 9 10 11

KSI & Alcohol Involved
 Alcohol was involved in over half of crashes resulting in a fatality or severe injury.

1 2 3 4 5 6
 7 8 9 10 11

Rear End
 Nearly 20% of all crashes were rear end.

1 2 3 4 5 6
 7 8 9 10 11

Left Turns
 More than 20% of drivers were making a left turn at the time of the crash.

1 2 3 4 5 6
 7 8 9 10 11

Broadside
 40% of all crashes were broadside, also called T-Bone.

1 2 3 4 5 6
 7 8 9 10 11

PEDESTRIAN

Pedestrian Crossing
 Almost all people hit while walking were crossing. 2/3 of people were in the crosswalk.

1 2 3 4 5 6
 7 8 9 10 11

Nighttime
 Half of pedestrian crashes occurred during nighttime or dark conditions.

1 2 3 4 5 6
 7 8 9 10 11

BICYCLE

Broadside
 3/4 of bicycle crashes were broadside, also called T-Bone.

1 2 3 4 5 6
 7 8 9 10 11

1 Numbers that are turned on represent a location where crash type has occurred at least three times.

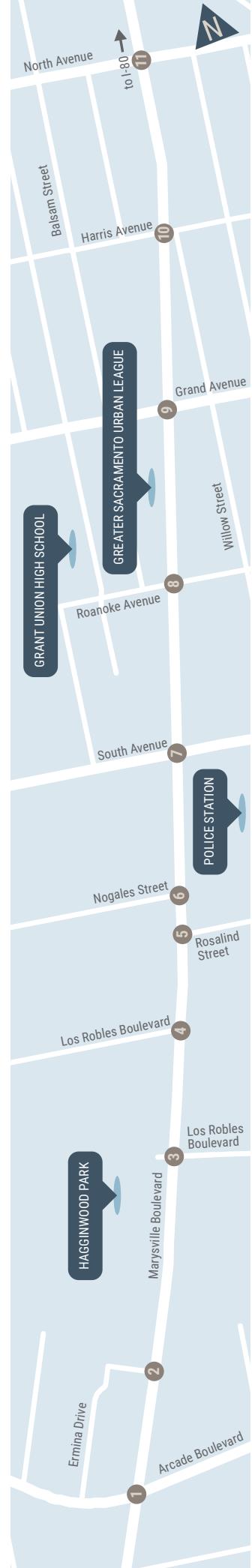
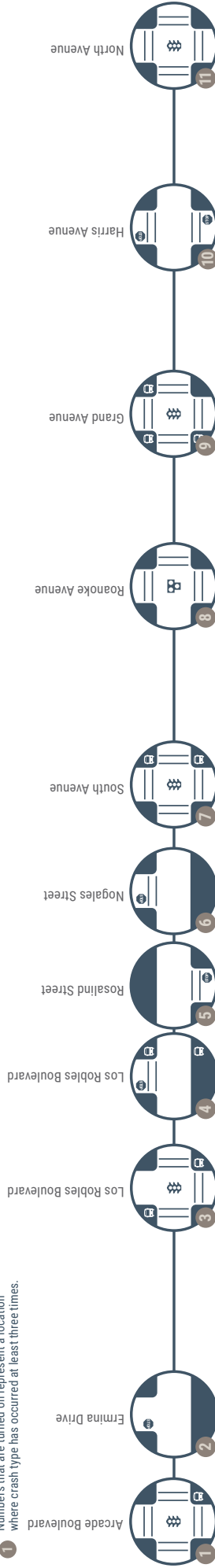

Feedback

Most of the comments received during outreach for Marysville Boulevard mentioned signals/signage and speeding. These comments are detailed in the *Community Outreach Report – Phase 1*, which is included in Appendix A.



Stockton Boulevard (South)

Existing Conditions

Stockton Boulevard between McMahon Drive and Patterson Way is a Top Five segment. This segment has a speed limit of 40 miles per hour, and an ADT of 29,700. Traffic counts were collected on May 31, 2018. The observed AM peak hour occurred between 7:15 and 8:15 AM with a PHF of 0.89 and two percent heavy vehicle count. During the peak hours, there were at least six bicyclists traveling through each study intersection and at least three pedestrians crossing at each study intersection along the corridor. The PM peak hour occurred between 4:15 and 5:15 PM with a PHF of 0.95 and one percent heavy vehicle count.

Figure 38 shows the travel patterns of this segment, and Figure 39 displays its existing conditions.

Vehicular Facilities

Figure 37: Stockton Boulevard (South)



On-street parallel parking is prohibited.

The *Sacramento General Plan 2035* characterizes this segment as an arterial where the LOS D standard of Policy M.1.2.2 applies. Table 14 shows the peak hour intersection operations of the Stockton Boulevard segment. All intersections operate acceptably during peak hours, except for the 37th Avenue approach of the Stockton Boulevard/37th Avenue intersection during the PM peak hour.

Table 14: Peak Hour Intersection Operations – Stockton Boulevard (South)

Intersection	Traffic Control ¹	AM Peak Hour		PM Peak Hour	
		Delay ² (s)	LOS ³	Delay ² (s)	LOS ³
Stockton Boulevard/37 th Avenue	SSSC	2.4 (19.5) (EB LT)	A (C)	4.2 (36.8) (EB LT)	A (E)
Stockton Boulevard/McMahon Drive	Signal	7.0	A	9.1	A
Stockton Boulevard/Lemon Hills Avenue	Signal	27.7	C	22.0	C
Stockton Boulevard/Dias Avenue	Signal	8.5	A	8.6	A
Stockton Boulevard/47 th Avenue/Elder Creek Road	Signal	38.5	D	45.8	D
Stockton Boulevard/Fowler Avenue/Riza Avenue	Signal	12.7	B	16.6	B

Notes:

1. Signal = traffic signal-controlled intersection; SSSC = side-street stop-controlled intersection
2. Average control delay for signalized intersections is the weighted average for all movements. For SSSC intersections, the delay and LOS for the highest delay movement is shown in parentheses.
3. LOS = level of service; calculated based on methodologies contained in the *Highway Capacity Manual, 6th Edition* (Transportation Research Board, 2016).

Bold text indicates unacceptable operations.

Source: Fehr & Peers, 2018.

FIGURE 38

STOCKTON BOULEVARD TRAVEL PATTERNS

Thursday, May 31st, 2018. 7:15-8:15 AM & 4:15-5:15 PM

Count Locations

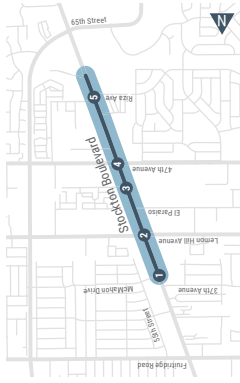

Legend

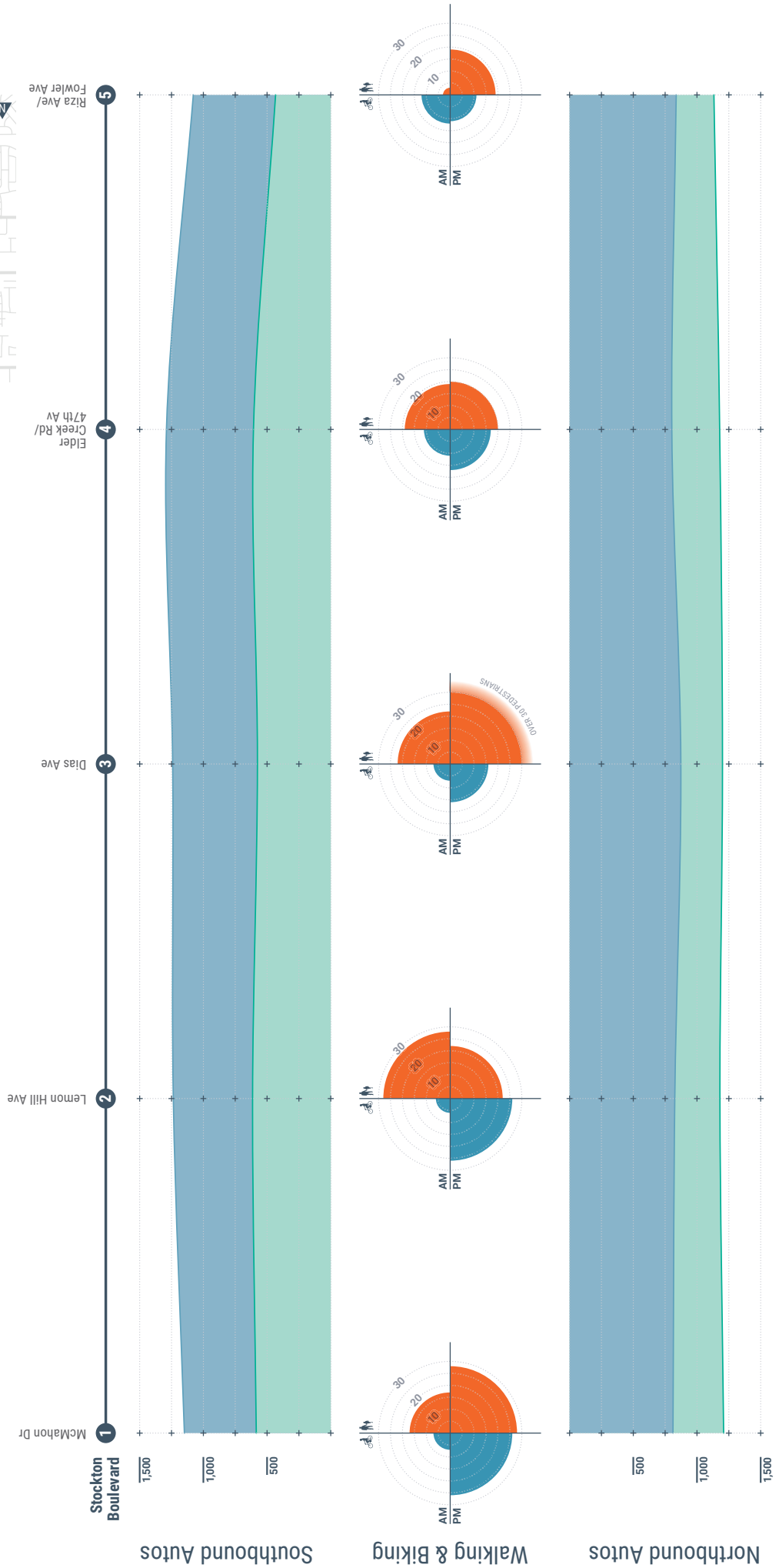
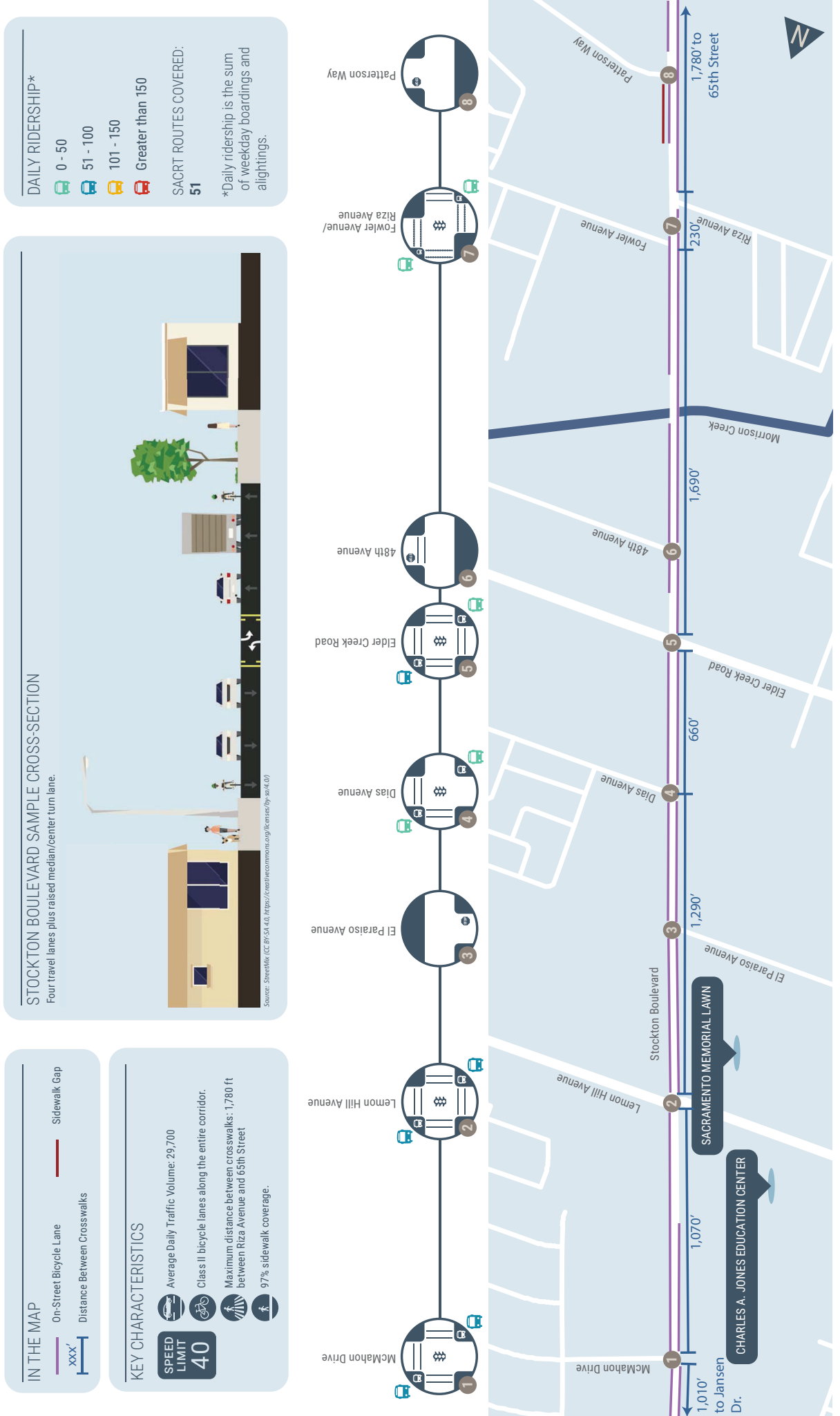

FIGURE 39

STOCKTON BOULEVARD - EXISTING CONDITIONS





Transit Facilities

Line 51 of Sacramento Regional Transit operates on Stockton Boulevard with 15-minute headways for its weekday operations. This line connects Florin Towne Centre to the Sacramento Valley train station and has the highest ridership of all bus routes in the RT system. On weekdays, it operates between 5:30 AM to 10:30 PM. On weekends and holidays, the line operates with half hour headways between 6:00 AM and 11:00 PM on Saturdays and between 6:00 AM and 9:30 PM on Sundays and holidays.

Most transit stops on this corridor are indicated by a Sacramento Regional Transit sign. There is a bench at the northbound stops at Stockton Boulevard/McMahon Drive and Stockton Boulevard/Dias Avenue. There is also a transit shelter at the northbound stop at Stockton Boulevard/Lemon Hill Avenue.

Pedestrian Facilities

There are sidewalks on both sides of the street that are typically 5.5 feet wide. A gap exists north of Patterson Way on the east side of the roadway.

There are crosswalks on all approaches of all signalized intersections on this segment, except for the south leg of Stockton Boulevard/Dias Avenue. None of the side-street stop-controlled intersections have marked crosswalks. The maximum distance between crosswalks within the segment extents are between south leg of Lemon Hill Avenue intersection and the north leg of the Dias Avenue intersection (1,290 feet). Just outside the segment, the crosswalk on the south leg of the Fowler Avenue/Riza Avenue intersection to 65th Street has a distance of 1,780 feet between crosswalks. All crosswalks on this corridor feature basic makings with solid lines.

Lighting is provided by overhead roadway light poles.

Bicycle Facilities

The segment has Class II bike lanes along the entire corridor, except for gaps going over Morrison Creek and by the Stockton Boulevard/Fowler Avenue/Riza Avenue intersection. There is also a gap on the west side of the road north of Lemon Hill Avenue intersection. The bike lanes are five-feet in width and are typically not blocked by obstructions.

StreetScore+

The StreetScore+ results for the bicycle and pedestrian facilities of Stockton Boulevard between 37th Avenue and Patterson Way are shown in Table 15. Because of the high posted speed limit, the bicycle and pedestrian scores are 4 for all segments. This indicates that only “strong and fearless” cyclist will tolerate the level of stress of the segment, and walking is very uncomfortable or impossible.

Table 15: StreetScore+ Results – Stockton Boulevard (South)

Segment	Direction	Bicycle StreetScore+	Pedestrian StreetScore+
Stockton Boulevard between Gordon Drive and 37 th Avenue	NB	4	4
	SB	4	4
Stockton Boulevard between 37 th Avenue and McMahon Drive	NB	4	4
	SB	4	4
Stockton Boulevard between McMahon Drive and Lemon Hill Avenue	NB	4	4
	SB	4	4
Stockton Boulevard between El Paraiso Avenue and Dias Avenue	NB	4	4
	SB	4	4
Stockton Boulevard between Dias Avenue and 47 th Avenue/Elder Creek Road	NB	4	4
	SB	4	4
Stockton Boulevard between 47 th Avenue/Elder Creek Road and 48 th Avenue	NB	4	4
	SB	4	4
Stockton Boulevard between 48 th Avenue and Fowler Avenue/Riza Avenue	NB	4	4
	SB	4	4
Stockton Boulevard between Fowler Avenue/Riza Avenue and Patterson Way	NB	4	4
	SB	4	4
Stockton Boulevard between Patterson Way and 65 th Street	NB	4	4
	SB	4	4

StreetScore+ ratings range from 1 through 4 with 1 representing low stress bicycle and pedestrian travel conditions and 4 representing high stress bicycle and pedestrian travel conditions.
Source: Fehr & Peers, 2018.

Collision Analysis







Figure 40 shows the locations of crashes on Stockton Boulevard. Figure 41 summarizes the crash types along the corridor. These figures were used as display boards during the Stockton Boulevard community workshop.

Along the Stockton Boulevard corridor, the most crashes occurred at the intersections of Lemon Hill Avenue and Elder Creek Road (35 crashes each). There were five KSI crashes at Lemon Hill Avenue, including two pedestrian KSI crashes. There were four KSI crashes at Elder Creek Road, including one pedestrian KSI crash and one bicycle KSI crash. One pedestrian KSI crash occurred at both Dias Avenue and 48th Avenue. One bicycle KSI crash occurred at each of the following locations: McMahon Drive, Fowler Avenue/Riza Avenue, and the midblock location between McMahon Drive and Lemon Hill Avenue.



FIGURE 40

STOCKTON BOULEVARD CRASHES

CORRIDOR CRASH SUMMARY (2009-2017)

	ALL INJURY CRASHES	140
	FATAL AND SEVERE CRASHES	16
	FATAL AND SEVERE CRASHES	7
	FATAL AND SEVERE CRASHES	20
	FATAL AND SEVERE CRASHES	5
	FATAL AND SEVERE CRASHES	4

KEY CHARACTERISTICS

-  **SPEED LIMIT 40**
-  Four travel lanes plus raised median/center turn lane.
-  Class II bicycle lanes along the entire corridor.

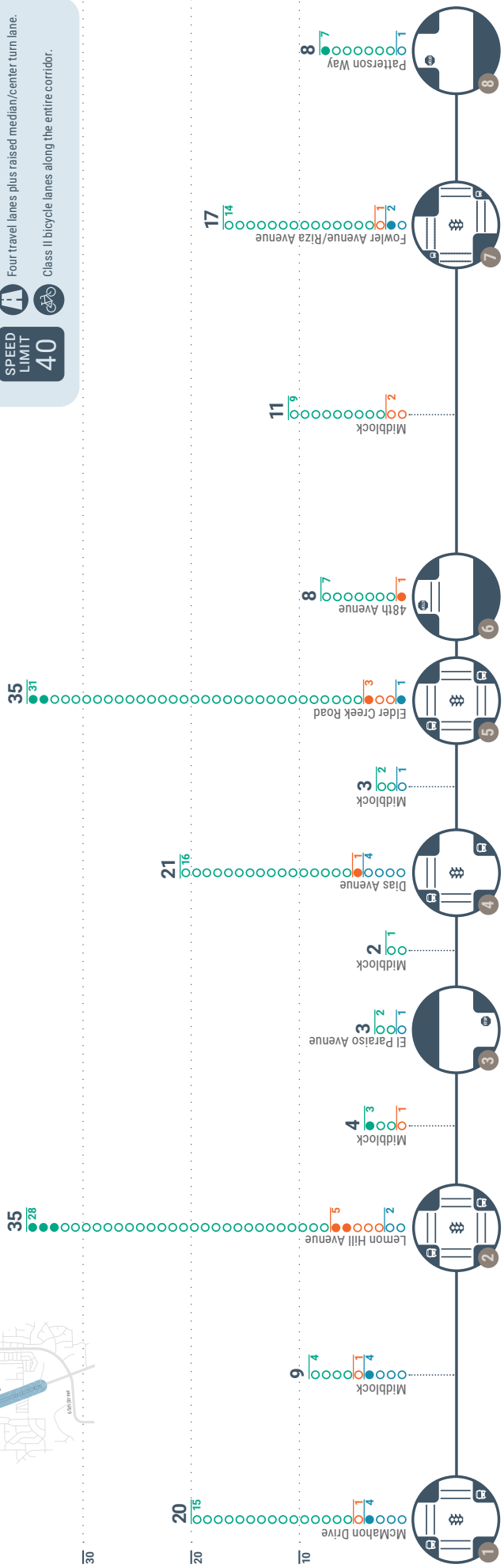
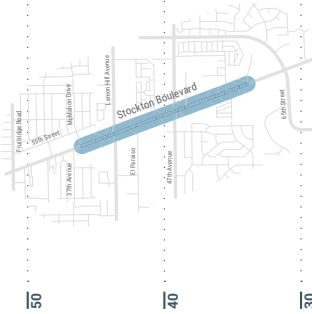

FIGURE 41

CORRIDOR-WIDE CRASH TYPES

VEHICLE

Unsafe Speed
 "Unsafe Speed" was the most common violation, cited in 35% of all crashes.

1 2 3 4 5 6
7 8

Proceeding Straight
 Nearly 3/4 of drivers were proceeding straight or stopped at the time of the crash.

1 2 3 4 5 6
7 8

Signal or Sign Violation
 "Traffic Signals and Signs" was tied for second most common violation category.

1 2 3 4 5 6
7 8

Under the Influence
 "Under the Influence" was tied for second most common violation category.

1 2 3 4 5 6
7 8

Rear End
 Over 35% of all crashes were rear end.

1 2 3 4 5 6
7 8

Left Turns
 65% of drivers who were turning at the time of the crash were making a left turn.

1 2 3 4 5 6
7 8

Broadside
 30% of all crashes were broadside, also called T-Bone.

1 2 3 4 5 6
7 8

Nighttime
 40% of all crashes occurred during nighttime or dark conditions.

1 2 3 4 5 6
7 8

PEDESTRIAN

Crossing in Crosswalk
 Nearly half of all pedestrians hit by a driver were in a crosswalk at the time of the crash.

1 2 3 4 5 6
7 8

Pedestrian in Road
 25% of pedestrians hit by a driver were walking along the road or shoulder.

1 2 3 4 5 6
7 8

BICYCLE

Broadside
 65% of bicycle crashes were broadside, also called T-Bone.

1 2 3 4 5 6
7 8

Right Turns
 1/3 of drivers who hit a bicyclist were making a right turn at the time of the crash.

1 2 3 4 5 6
7 8

1 Numbers that are turned on represent a location where crash type has occurred at least three times.

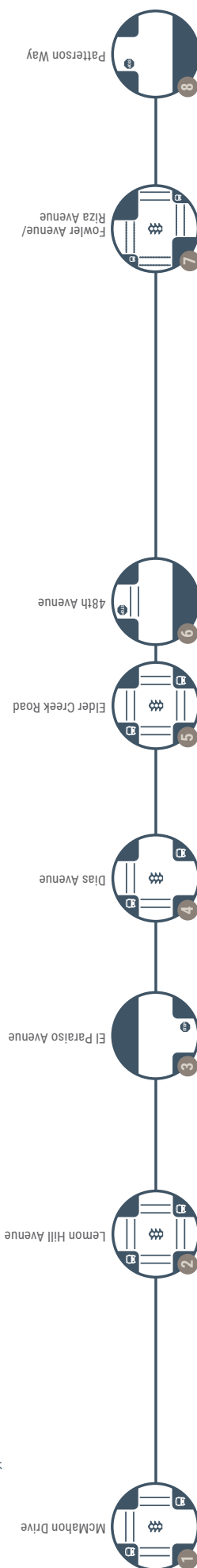



Crashes involving a vehicle proceeding straight or stopped, unsafe speed violations, and rear end crashes were very common along South Stockton, with at least three crashes of each crash type occurring at almost all intersections. Other common crash types along the corridor include:

- Vehicle left turns (McMahon Drive, Lemon Hill Avenue, Dias Avenue, Elder Creek Road)
- Broadside crashes (McMahon Drive, Lemon Hill Avenue, Dias Avenue, Elder Creek Road, Fowler Avenue/Riza Avenue)
- Signal or sign violations (McMahon Drive, Lemon Hill Avenue, Dias Avenue, Elder Creek Road)
- Under the influence violations (Lemon Hill Avenue, Elder Creek Road)
- Nighttime crashes (McMahon Drive, Lemon Hill Avenue, Dias Avenue, Elder Creek Road, Fowler Avenue/Riza Avenue, Patterson Way)
- Pedestrian hit while crossing in crosswalk (Lemon Hill Avenue)
- Bicycle crashes involving right-turning vehicles (Dias Avenue)

Feedback

Most of the comments received during outreach for Marysville Boulevard mentioned enforcement and bike safety. These comments are detailed in the *Community Outreach Report – Phase 1*, which is included in Appendix A.

References

City of Sacramento, March 2015. *Sacramento General Plan*.

City of Sacramento, March 2015. *Sacramento General Plan EIR*.

City of Sacramento, August 2018. *Vision Zero Action Plan*.

City of Sacramento, December 2018. *Vision Zero Top 5 Corridors Study: Community Outreach Summary Report – Phase 1*.

Fehr & Peers, April 2016. *StreetScore+: Comfort and Level of Traffic Stress Scoring Methodology for Bicyclist and Pedestrians*.

Maaza C. Mkuria, Peter G. Furth, and Hilary Nixon, 2012. *Low-Stress Bicycling and Connectivity*.

National Association of City Transportation Officials, October 2013. *Urban Street Design Guide*.

National Association of City Transportation Officials, March 2014. *Urban Bikeway Design Guide, 2nd Edition*.

Safe Transportation Research and Education Center (SafeTREC) at the University of California, Berkeley, June 2018. Transportation Injury Mapping System [database].

Transportation Research Board, 2016. *Highway Capacity Manual, 6th Edition A Guide for Multimodal Mobility Analysis*.

Appendix A – Phase 1 Outreach Summary



Vision Zero Top 5 Corridors Study

Community Outreach Summary Report | Phase I

FALL 2018

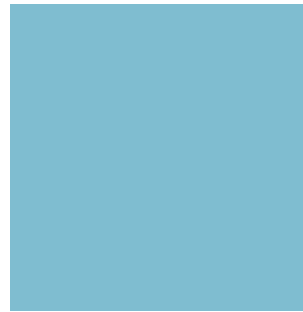

Table of Contents

- About the Study
- Community Outreach Program
- Compilation of Input by Corridor
 - Marysville
 - El Camino
 - Broadway / Stockton
 - South Stockton
 - Florin
- Public Notification
- Appendix



About the Vision Zero Top Five Corridors

In 2017, the City of Sacramento identified five corridors in Sacramento with the highest numbers of fatal and serious crashes involving pedestrians, bicyclists, and motorists.

The purpose of the Vision Zero Top Five Corridor Study is to analyze the factors that contribute to these corridors' high crash rates and propose improvements for each corridor that can be implemented near-term. Improvements are based on technical analysis, community input, and best practices in roadway safety and design.

Each of the five corridors span about one mile and are shown on the map to the right and listed below:

Marysville Boulevard

North Avenue to Arcade Boulevard

El Camino Avenue

Del Paso Boulevard to the paved levee trail adjacent to Steelhead Creek

Broadway / Stockton Boulevard

Martin Luther King Jr. Boulevard to 13th Avenue

South Stockton Boulevard

McMahon Drive to Patterson Way

Florin Road

24th Street to Munson Way

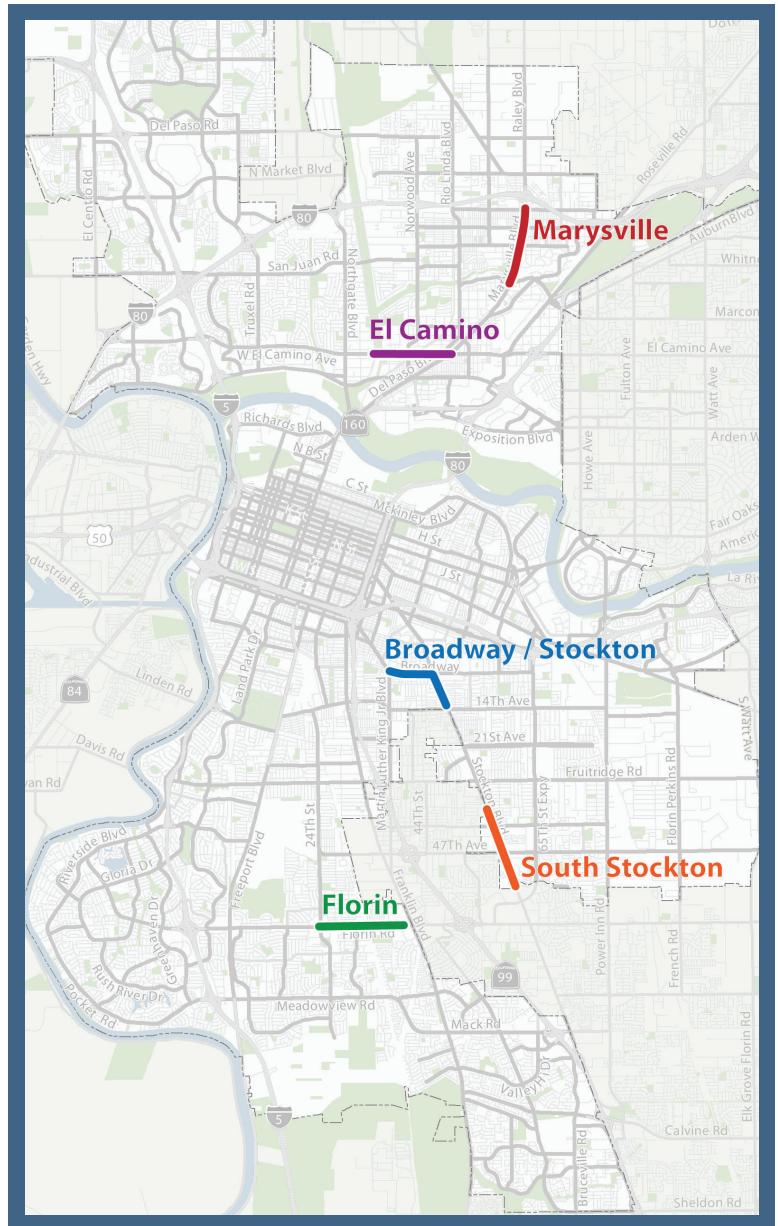

Community Outreach Program

Community outreach is an important component of the Vision Zero Top Five Corridor Study. Technical data and analysis can identify where crashes take place along a corridor, how often they take place, and the types of crashes. However, community input is needed to help tell the whole story – including the experiences of those who travel along the corridors, their observations of how others are traveling within the corridor and what and where they see the challenges. Feedback from the community about these topics can better inform the study's countermeasures, which will address specific traffic and safety challenges along each of the top five corridors.

The community outreach program includes two phases:

Phase 1 (October – December 2018)

Objectives

- Build community awareness about the Vision Zero Top Five Corridors Study
- Present an overview of existing conditions along the top five corridors
- Obtain community input on the community's experiences traveling along the top five corridors
- Educate the community on the importance of traffic safety

Phase 2 (Spring – Summer 2019)

Objectives

- Present draft countermeasures developed based upon technical analysis, best practices in traffic engineering, and community input.
- Obtain community input on the draft countermeasures.
- Educate the community on the importance of traffic safety



Leslie Mancebo, City of Sacramento, discusses the **Broadway / Stockton** Corridor with a community member at the SacRT transit stop by Food Source.

PROJECT SCHEDULE

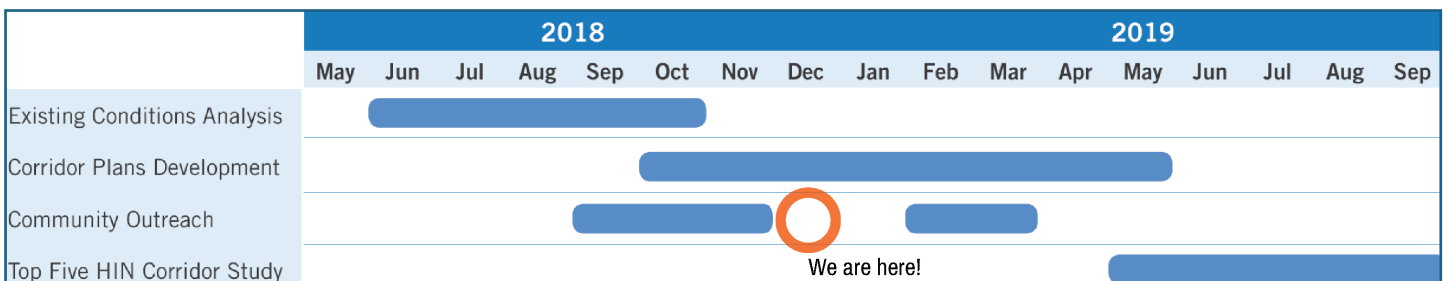

The City of Sacramento Vision Zero team held a total of six pop-up events and two community workshops throughout the top five corridors.

The purpose of the pop-up event series and community open houses were to engage community members who regularly travel along the corridors and find out their experiences walking, biking, and driving along the corridor. The project team held the pop-up events at community hubs and community events near each corridor. Community workshops were held at local schools near each of the corridors. The project team engaged more than 100 community members throughout the Phase 1 of public outreach.

At each of the outreach events community members were provided technical information represented graphically on a series of display boards relevant to one of the top five corridors, depending on the location of the event, as well as an overview of the project background. The boards included the following information:

Project Overview and Background

- o These displays provided an overview about the Vision Zero Top Five Corridors Study and a project schedule along with a map of all corridors within the City.

Existing Conditions of the Corridor

- o This display included key characteristics of the corridor, such as the average daily traffic volume, length of bike lanes, distance in-between crosswalks, and the percentage of sidewalk coverage along the corridor. It also displayed an illustrative drawing of a sample cross-section of the existing conditions, daily transit ridership numbers, and transit stop locations.

Corridor Crash Analytics

- o This display presented a summary of all crashes involving vehicles, pedestrians, and bicyclists along the specific corridor from 2009 to 2017. It showed where these crashes have taken place and specified if the crash resulted in an injury or fatality.

Corridor-Wide Crash Types

- o This display presented the different types of crashes that had taken place along the specific corridor from 2009 to 2017, for each mode of transportation that was involved in a crash.

Community Input Board

- o This board asked community members to respond to the prompt, "Tell us about your experience traveling long [specific corridor]." The intent was to understand the community members experience traveling within the corridor, their observations, concerns and ideas for improvement.



David Carter, Fehr & Peers, and Nicole Porter, AIM Consulting, pose with batman at the **Broadway / Stockton** pop-up event at the Oak Park Community Center Harvest Festival.

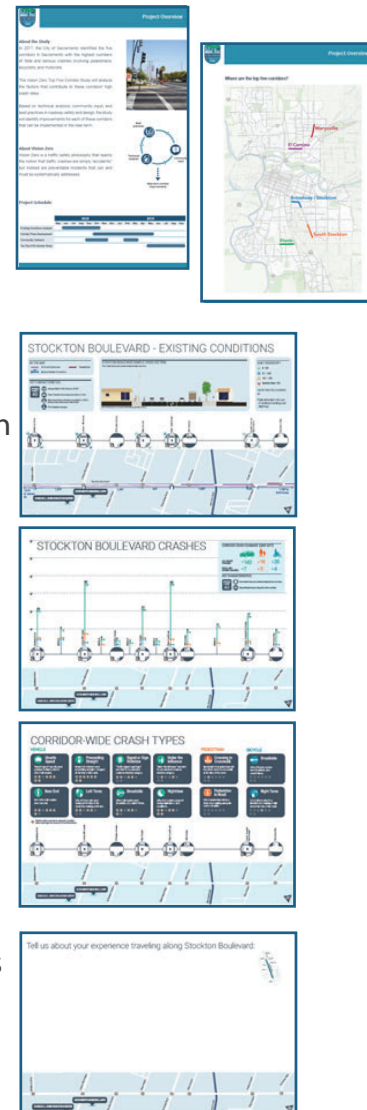

The boards listed above can be found in the appendix of this document.

During each outreach event, community members were asked to review the project boards and share their experiences traveling within the corridor. Participants wrote their comments on post-it notes and placed their comments on board exhibits. Project team members at the pop-up events wrote down additional comments from one-on-one discussions with participants, which included ideas and suggestions for needed improvements along the corridor to enhance safety.

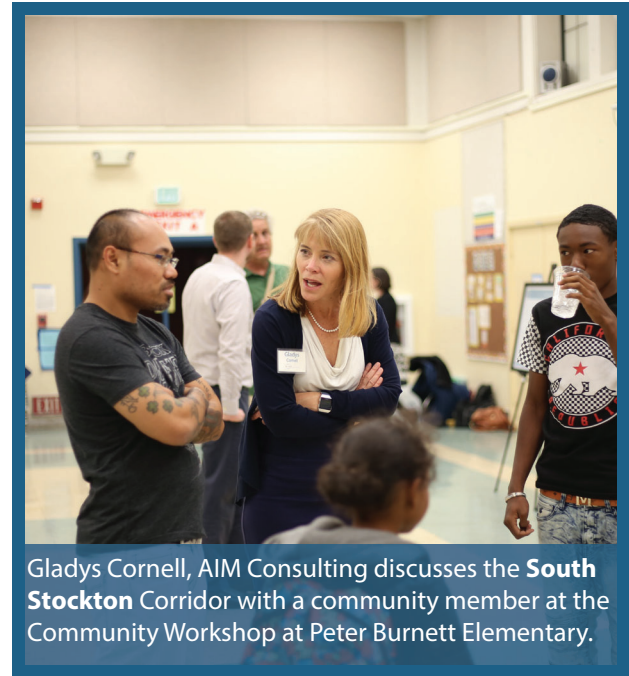
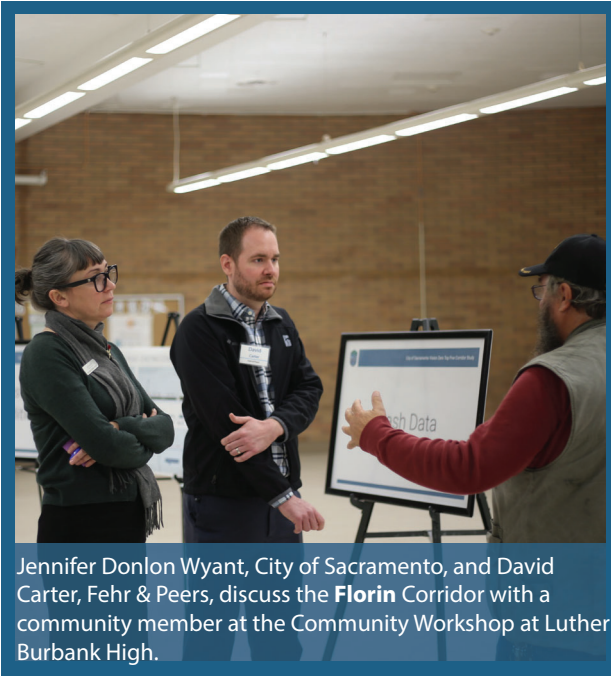

The outreach events were held from October through early December of 2018 and are listed by date and corridor below.

PHASE 1 OUTREACH EVENTS

October 25	Fall Family Festival Broadway / Stockton Corridor <i>Oak Park Community Center</i>	November 10	Old North Sacramento / Dixieanne Community Association Meeting El Camino Corridor <i>701 Dixieanne Avenue</i>
October 27	Mutual Assistance Harvest Festival Marysville Corridor <i>Robertson Community Center</i>	November 15	Community Workshop Florin Road Corridor <i>Luther Burbank High School</i>
November 5	Community Workshop South Stockton Corridor <i>Peter Burnett Elementary School</i>	December 4	Grocery Outlet El Camino Corridor <i>Grocery Outlet on Del Paso Boulevard</i>
November 7	Transit stop at Broadway / Stockton Broadway / Stockton Corridor <i>WB Transit Stop by Food Source</i>	December 5	Hagginwood Community Association Meeting Marysville Corridor <i>William J. Kinney Police Facility</i>

Compilation of Input by Corridor

The following pages reflect the input received at each pop-up event and community workshop facilitated by the project team.



Marysville

North Avenue to Arcade Boulevard



Existing intersection on Marysville Boulevard.

The project team held two pop-up events to obtain community input on the Marysville Corridor:

- Mutual Assistance Network Harvest Festival on Saturday, October 27, at the Robertson Community Center
- Hagginwood Community Association Meeting on Wednesday, December 5th, at the William J. Kinney Police Facility

Below is the feedback received from each event distributed into relevant categories. The graph below depicts the amount of input received in each category.

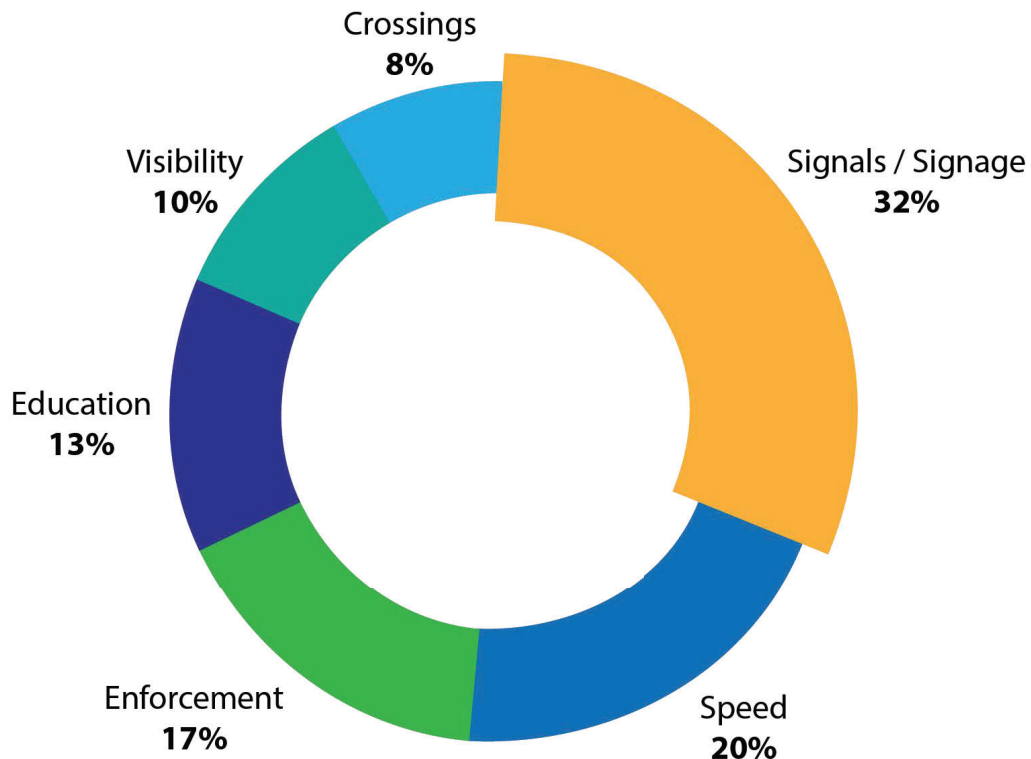

Comments received from post-it notes on project boards:

Crossings

- Very difficult to cross the street as a pedestrian. Flashing beacons or lights flashing on the street would make it safer.
- There are too many kids and people jay-walking across the street. The crosswalks are too far apart so people don't use them.
- Pedestrians don't pay attention when crossing the street - we need more cross walks.
- Crosswalks need flashing beacons - people are unaware they are there without them.
- We need bump outs for pedestrians to better alert drivers, so they can visually see where they would be.



Community members creating reflective stickers at the Harvest Festival.

Enforcement

- Marysville needs law presence for more phone enforcement and reckless driving enforcement.
- More enforcement needed at signals.
- Drivers don't pay attention, they are on their cell phones, and don't seem to care about pedestrians.
- We need more police enforcement, particularly for speeding.
- Drivers don't pay attention to pedestrians.
- Enforce traffic violations.
- More enforcement to keep drivers off of their cell phones.
- I see a lot of jay-walking, especially near liquor stores and the park.
- There are too many jay-walkers and red light-runners
- Viva Supermarket, Rainbow Market, 3621 Mini mart, Quick Stop, and Arcade Market all have vagrants that loiter and constantly jay-walk back and forth across Marysville Boulevard.

Education

- PHB: Education needed for drivers and pedestrians.
- Educate people on what the signals mean.
- Education about signals and road laws in the area is needed.
- Education on the new traffic beacons is needed, then add more of them.
- this area could use traffic safety / signal classes (for free!)
- Education needed about PHB.
- People drive too fast, drivers don't know what to do at PHB. We need more cross walks, better pavement and more lighting for overall visibility.
- A video series for cyclists to learn the rules of the road is needed.



Rebecca Shafer helping community members make reflective stickers at the Harvest Festival.

Speed

- Cars drive too fast.
- People drive too fast.
- Speeding is an issue.
- Speeding is an issue, and sidewalks disappear.
- Speeding is an issue, drivers don't follow the law and drive aggressively.
- Slow down traffic, drivers go over 35 MPH.
- Speeding is a problem!
- People speed too often.
- I take the side streets to avoid Marysville Boulevard because people drive way too fast.
- Speeding is an issue.
- Paint the speed limit on the street.
- Marysville Boulevard is becoming a shortcut to downtown.



Jennifer Donlon Wyant, City of Sacramento, discussing the Marysville corridor with families at the Harvest Festival.

Signals / Signage

- We need more signal lighting.
- The signals are slow, so people run them.
- More cross walks, more PHB / HAWLK signals. But educate people on them.
- Make cars aware of crosswalks, more lighting to see pedestrians at night would also help. Pedestrian flashing beacons are safe and keep the flow of traffic.
- The Los Robles signal is confusing and needs a left turn signal.
- More signals and more cross walks would make Marysville Safer.
- More signals needed for pedestrians to cross.
- People don't yield where they are supposed to.
- Roanoke pedestrian hybrid beacon.
- Audible pedestrians' heads - do they show better crossing compliance?
- Los Robles at Quick Stop, pedestrian button stolen?
- Westbound Arcade Boulevard to north bound Marysville needs a green arrow for making a turn onto northbound Marysville.
- Arcade and Marysville - no ped heads?
- Vehicle turn lanes help on two-way turn lanes.
- Arcade to Marysville needs turn signal heads.
- Marysville and North Avenue: Cars pull out into traffic for right turn when there is inadequate clearance to do so which causes traffic to slow.
- Left hand turns at Arcade feel like I'm taking my life into my hands every time I turn left. Bicyclists and walkers crossing or walking in streets against red lights.
- Lane striping needs refreshing.
- Need better street signs, I can't see them.

Visibility

- More street lights and cross walks needed.
- Bushes on the dividers make it hard to see oncoming traffic, and hard to make left turns.
- Center medians are not reflective and hard to see at night and the markings are hard to see.
- It's hard to see pedestrians southbound on Marysville, onto Rosalind Street.
- Marysville and Los Robles: View of north bound traffic is obstructed by cars at the gas pumps at the market.
- Corridor is too dark.
- I live by Del Paso and Marysville Boulevard, that neighborhood needs lighting.

El Camino

Paved levee trail adjacent to Steelhead Creek to Del Paso Boulevard



The project team held two pop-up events to obtain community input on the El Camino Corridor:

- Old North Sacramento / Dixieanne Community Association Meeting, Saturday, November 10, at Grace City, located at 701 Dixieanne Avenue
- Grocery Outlet Store, Tuesday December 4, located at the Grocery Outlet along the corridor

Below is the feedback received from each event distributed into relevant categories. The graph below depicts the amount of input received in each category.

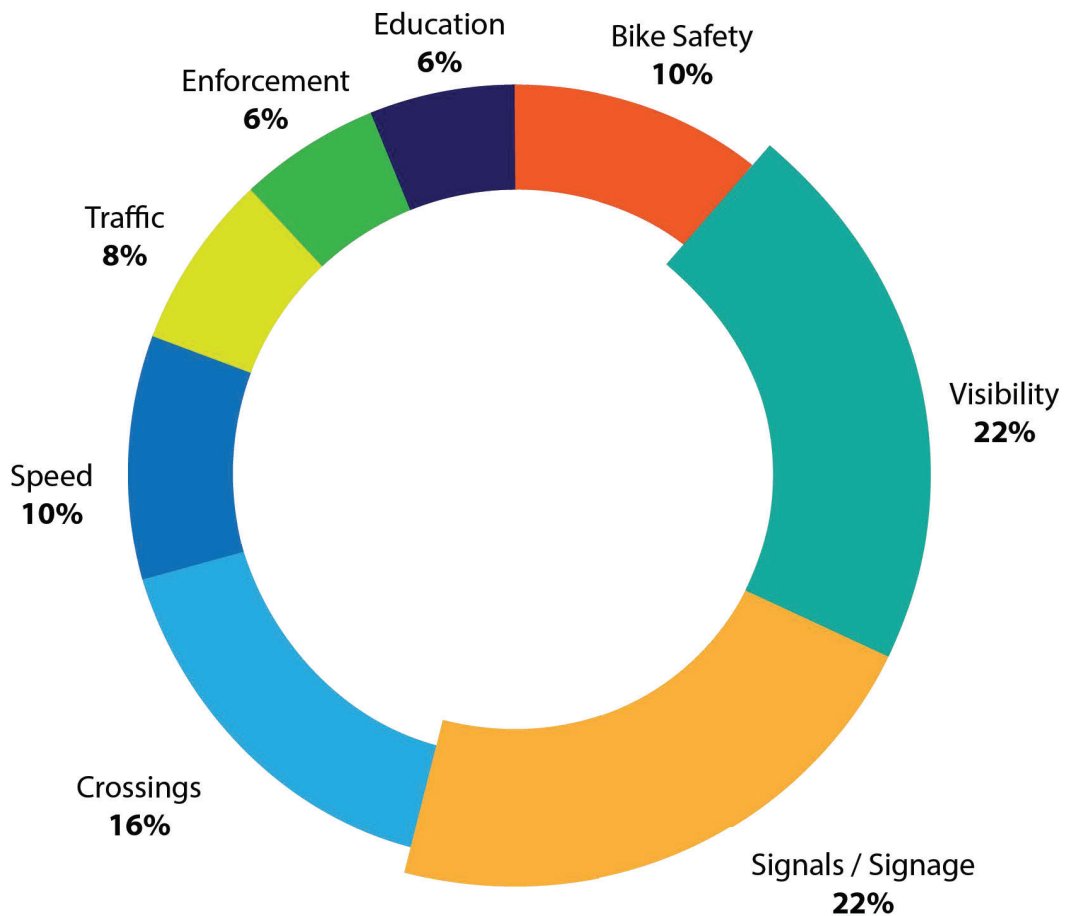

Comments received from post-it notes on project boards:

Bike Safety

- Altos / Traction meets the bikes path, there is a lot of bike activity there and no bike lanes / bike safety.
- Bike lanes along this corridor have obstructions or are non-existent.
- Bike lanes are too skinny.
- "Fake" bike lanes, we need better lighting to see people, and a barricade to separate cars.
- West El Camino towards Northgate: not a lot of room for cyclists.
- It can be frightening to bike on El Camino.
- Bicyclists have to take a lot of precautions because of fast traffic.

Visibility

- Difficult to pull out of my driveway on El Camino, need slower speeds there and better visibility.
- It's hard to pull out to El Camino from side streets because its hard to see.
- Need better lighting at night.
- Mid-block crashes: a lot of homes have their driveways backing into El Camino - there is unsafe backing out due to high speeds and visibility issues.
- The City needs to trim their trees for visibility, particularly in front of stop signs.
- You cannot see getting onto El Camino from the side streets.
- El Camino needs more lighting in general - more street lights improve visibility
- Hard to turn off of El Camino onto other streets
- Visibility for cyclists is bad on El Camino, especially when it gets dark since the lighting is bad. I have to ride in the gutters and sometimes there is debris.
- Del Paso Boulevard and Rio Linda: People cannot see the stop sign and there is about one accident per month. El Camino is not wide enough.
- On El Camino Avenue, everything is too close together, it's constricting and hard to see at night.
- At night people walk directly in front of cars.
- Need more lighting.



Rebecca Shafer, Fehr & Peers, discussing the El Camino corridor with individuals at the Community Association Meeting.

Speed

- The speed on El Camino is too high.
- El Camino and Grove Avenue needs to be widened and slower traffic speeds to make it safer.
- I try to avoid El Camino because there are random pedestrians and people drive too fast.
- Aggressive driving and road rage on El Camino.
- The street is too narrow, and traffic moves too fast.
- There is one light port in my neighborhood and speed bumps that were installed at Del Paso and Arden Arcade.
- Traffic needs to slow down, especially by crosswalks.



Project team members discussing the corridor crash types at Grocery Outlet.

Crossings

- There is systematic Jay-walking on El Camino.
- Fairfield and El Camino: There is no cross walk, all intersections should have cross walks with crossing lights.
- Crossings along here are not pedestrian-priority, people jay-walk because of it.
- Jay-walking becomes a culture because of the long waits - it's a systematic issue.
- Weird striping for the West Bound approach at Grove.
- It's a nightmare to walk on a 3-way split at Del Paso, Arden, and El Camino.
- Homeless people walk across the street and hang out in the medians sometimes by the overpass.
- They added a new light for the crosswalk, but no one uses it.
- Sometimes it's difficult to walk on El Camino because cars travel too fast.
- At the intersection of Del Paso and El Camino, it is hard to cross the street. There aren't crosswalks for every street, but people won't wait forever for the light, so they walk where there is no crosswalk anyway.
- Look into mid-block victims in this study.

Signals / Signage

- People Jay-walk because the Del Paso and El Camino is too long of a wait.
- Too many traffic signals on El Camino create the problem.
- More Vision Zero signs on El Camino are needed.
- With too many signals, people stop using them.
- Stop signs with red flashing lights around it draws more attention.
- Speed sign feedback: drivers don't wait for pedestrians to get to the sidewalk, flashing lights will call attention to stop signs, as will trimming trees so they are easier to see.
- Colfax and El Camino: Signal timing: too many cars end up waiting for the long signal, then people run red lights
- Signalized cross walks needed.
- "Slow Down" banners would be helpful.
- The Speed feedback sign has been helpful in slowing speeds on Del Paso.
- Signage reminding people to slow down and that they are driving in a residential area.
- El Camino needs stop signs and speed bumps.
- Light at the El Camino corner is highly dangerous. The lanes are also small.
- It's hard to cross at Rio Linda.
- People jay-walk when the lights don't turn for a long time. But some people don't want to stop traffic with the cross walk.
- There are no stop signs on El Camino, which is unsafe as a pedestrian. A friend was hit by a car at 5:00 a.m. and the specific travel times are too fast. Everyone talks about the speed issue, there needs to be more signs and speed bumps to slow cars down. Travel time needs to be better [rush hour].

Enforcement

- There is too much neglectful driving, we need more enforcement, and the Police drive too fast to see.
- More traffic enforcement needed.
- I walk across where Wienerschnitzel is, and some driver ran the red light. If I didn't dive out of the way, I would've been hit.
- Distracted driving with cell phones and jay-walking is a problem on El Camino.

Broadway / Stockton

Martin Luther King Jr. Boulevard to
13th Avenue

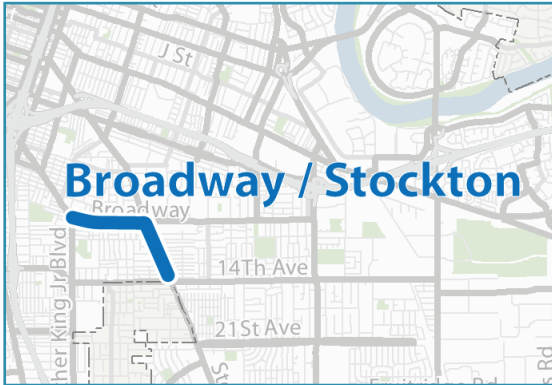

The project team held two pop-up events to obtain community input on the Broadway / Stockton Corridor:

- The Fall Family Festival on Thursday, October 25, at the Oak Park Community Center
- Transit stop at Broad/way Stockton on Wednesday, November 7, in front of the Food Source

Below is the feedback received from each event distributed into relevant categories. The graph below depicts the amount of input received in each category.

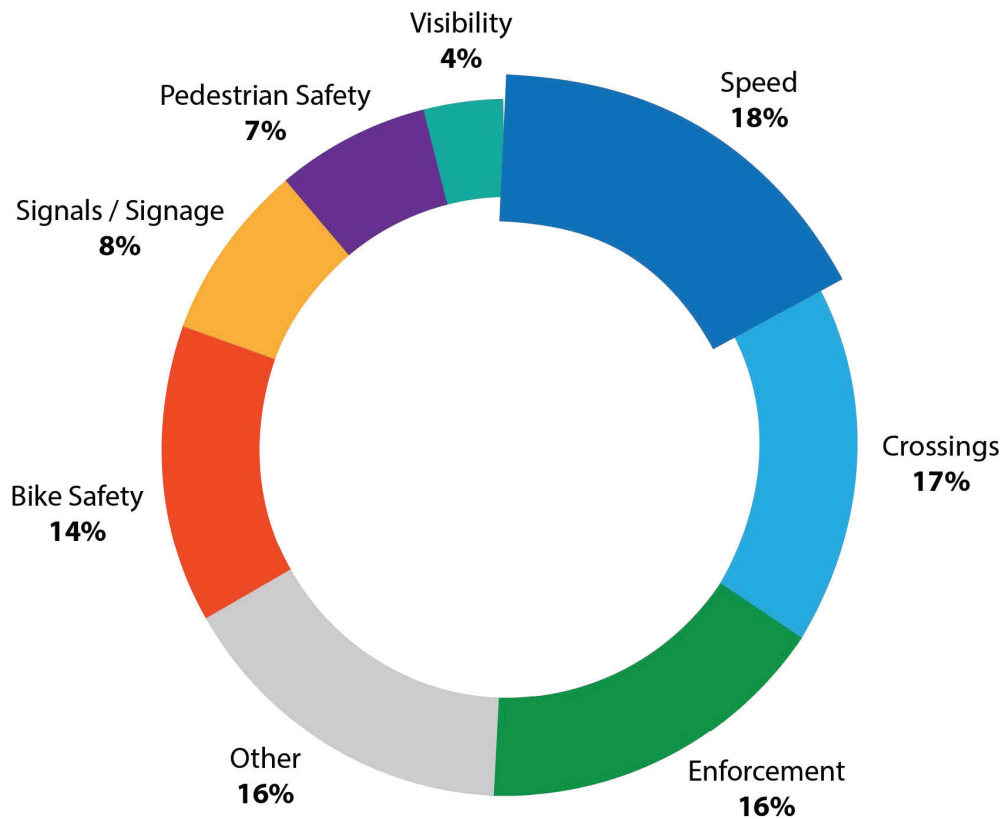

Comments received from post-it notes on project boards:

Signals / Signage

- Cars make left turn from MLK onto Broadway and don't stop or look for people walking.
- Drivers are distracted, and there's a lot of activity happening, especially at the intersection.
- Even when light says you can walk, I stop to make sure they aren't running the red light.
- Need more lights - it isn't convenient for drivers, but it will slow them down and make the area safer.
- Need a double turn lane on Broadway Stockton.
- We need more traffic signals.
- Traffic light timing is a problem, and we need wider lanes on Broadway.

Pedestrian Safety

- Pedestrians usually follow the rules of the road.
- This is a more populated low-income area, so there are more people walking.
- Stockton and 14th - South bound right turn don't look for pedestrians, nor do they stop for pedestrians.
- I drive slower here because I've almost hit other people.
- More people walk around this area than in other places.
- Just saw a family get hit by Mack/Valley Hi, the car drove away.



Nicole Porter, AIM Consulting, discussing the crash data along the Broadway / Stockton Corridor.

Speed

- Speeding - drivers drive too fast and need to slow down.
- My transit stop is at 38th and MLK. My whole family walks from 18th Street and cars drive way too fast.
- Cars speeding! It feels dangerous to bike even in the bike lanes. Cars don't yield to pedestrians. It's difficult as a cyclist to make turns. Work crews always put signs in their bike lanes, and the bike lanes often have a lot of debris/leaves in them which makes it difficult to share the lane.
- On MLK cars drive way too fast and drive too close to the sidewalk.
- Enforce a speed limit and have flashing stop signs.
- I walk to the 51-bus route, usually around Mack and Valley Hi. Cars are going too fast - watch yourself.
- You see a lot of other drivers going fast or angrily.
- Buses speed on Broadway and there is already too much traffic on Broadway. We need more crosswalks.
- Slow the streetcars and create traffic calming mechanisms.
- People drive too fast and run the right turn red lights at the Broadway / Stockton intersection.
- More narrow lanes to slow traffic and make us safer.
- A 2-lane bridge to drive over, like freeways have, so we can keep the freeway speed off this corridor.
- Broadway segment is too many lanes for residential nature - the speed is too high.
- Shrink the lane sizes.
- Better speed enforcement and complete bike lanes.

Bike Safety

- Nurses ride bikes up Stockton early in the morning, on the way to the UCD Med center - from Tahoe park onto Stockton.
- It's difficult to commute to midtown from Stockton Boulevard because all bike lanes end at Broadway / Stockton. It's an uncomfortable corridor to bike on.
- I don't ride my bike on Broadway because it is too fast - we need slower traffic from Central Oak Pak to the UC Davis Medical Center.
- "Disappearing bike lanes" - we need continuing bike lanes.
- No more disappearing bike lanes please.
- Disappearing, reappearing, disappearing bike lanes. Park / bike lanes look similar and usually have cars parked in it. Bike lanes are always the minimum width and the car lanes are huge.
- Direct bike traffic onto 8th Avenue or 1st or 2nd Avenue, they have slower traffic.
- Make bike lanes continuous!
- People always drive in the bike lanes.
- The bike lanes aren't ever cleaned.
- Reflective gear for cyclists is so important.
- Try temporary fixes to make bike lanes continuous and safe.

Crossings

- I take light rail by AutoZone and walk down MLK - we need a crossing between the firehouse and Happy Takeout - a lot of people, students included, jay-walk.
- On the Stanford Market intersection, cars pass through the bike area.
- Crossing guards are needed by the schools.
- Marked crosswalk at 7th was removed, but people still use, and since it's no longer marked, drivers are more aggressive.
- Pedestrian lights, flashing cross walks
- Even when pedestrian crossing lights are on, people are cautious to cross - cars too.
- Enforce pedestrian crossing at crosswalks.
- Lots of jay-walking along here.
- Zebra crossing at Broadway / Stockton (See UC Davis Med Center).
- South Stockton - pedestrian overpass needed to prevent jay-walking.
- Right turn on red and not enough crossings.
- More crosswalks! Cars do not stop, and there are bus stops not too far from crosswalks.
- Pedestrians don't pay attention and people don't use cross walks because they are too far away.



Councilmember Eric Guerra, District 6, and Leslie Mancebo, City of Sacramento, live streaming the transit stop pop-up event.



David Carter, Fehr & Peers, recording input from a community member at the transit stop pop-up event.

Enforcement

- People cut me off while driving, drive too fast, texting while driving
- Distracted driving is an issue.
- More enforcement needed - police need to do their jobs and write tickets.
- Drunk driving is a big problem here.
- Tent pop-ups along Broadway are distracting.
- People don't stop at red lights on a right turn on Broadway / Stockton.
- Red light running is a problem at the Broadway / Stockton Intersection.
- Distracted driving, specifically cell phones, is a huge problem.
- More cops need to be around to enforce the rules of the road: people always speed and jay-walk.
- Cameras to monitor traffic speeds might help with speeding and light running.
- Greater / enhanced traffic enforcement through SacPD and UC Davis.
- Since this area is higher crime, there should be more traffic enforcement officers.
- Red light enforcement cameras or the police.
- Police officers from UC Davis and SacPD need to enforce traffic laws.

Visibility

- Better street lighting is needed on Stockton.
- Light up the intersection so drivers can see pedestrians.
- I walk in the street because the sidewalks are so dark - we need better lighting.
- Blind corner at Martin Luther King Jr. Boulevard / Broadway.

Other

- I usually drive or take SacRT to Cosumnes River College - the bus doesn't stop if homeless people are around, and sometimes when it's busy or late, I must walk to the bus and it's difficult.
- I normally drive around those streets early, at 6:00 a.m., up Stockton to Alhambra.
- Driving on Broadway - the road maintenance is bad and there are too many lanes.
- Stockton to Martin Luther King Jr. Boulevard has cracked pavement that ruins cars.
- Drunk driving along this corridor is an issue.
- Oakridge school parents drive here.
- I go to PS7, no one walks off campus.
- I work at the community center and prefer to go down 8th and Broadway than go on Broadway / Stockton.
- DMV tests - people that drive here don't know how to handle a car and there is too much distracted driving.
- The community should help clean up the street, more receptacles would help.
- Paint green specifically around the corners / problem areas of this corridor.
- The pavement quality is bad and distracting at 39th and Broadway.
- Broadway is too narrow and windy.
- Widen Broadway, two lanes are not large enough.



Nicole Porter, AIM Consulting, discussing biking on the Broadway / Stockton Corridor with a student.



Community member providing input on the Broadway / Stockton Corridor at the transit stop pop-up event.

South Stockton

McMahon Drive to Patterson Way

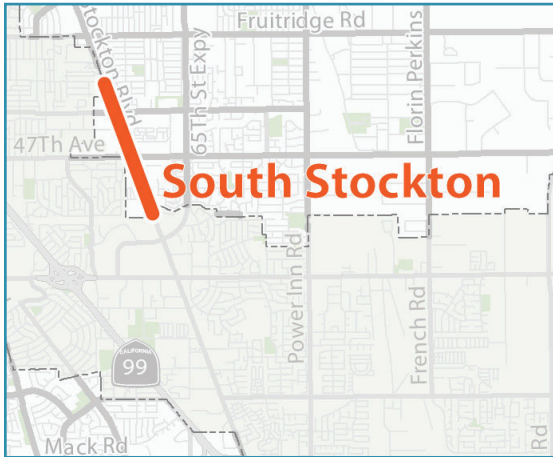

Existing intersection on the South Stockton corridor.

The project team held one community workshop to obtain community input on the South Stockton Corridor at Peter Burnett Elementary School, on Monday, November 5.

Below is the feedback received from the workshop distributed into relevant categories. The graph below depicts the amount of input received in each category.

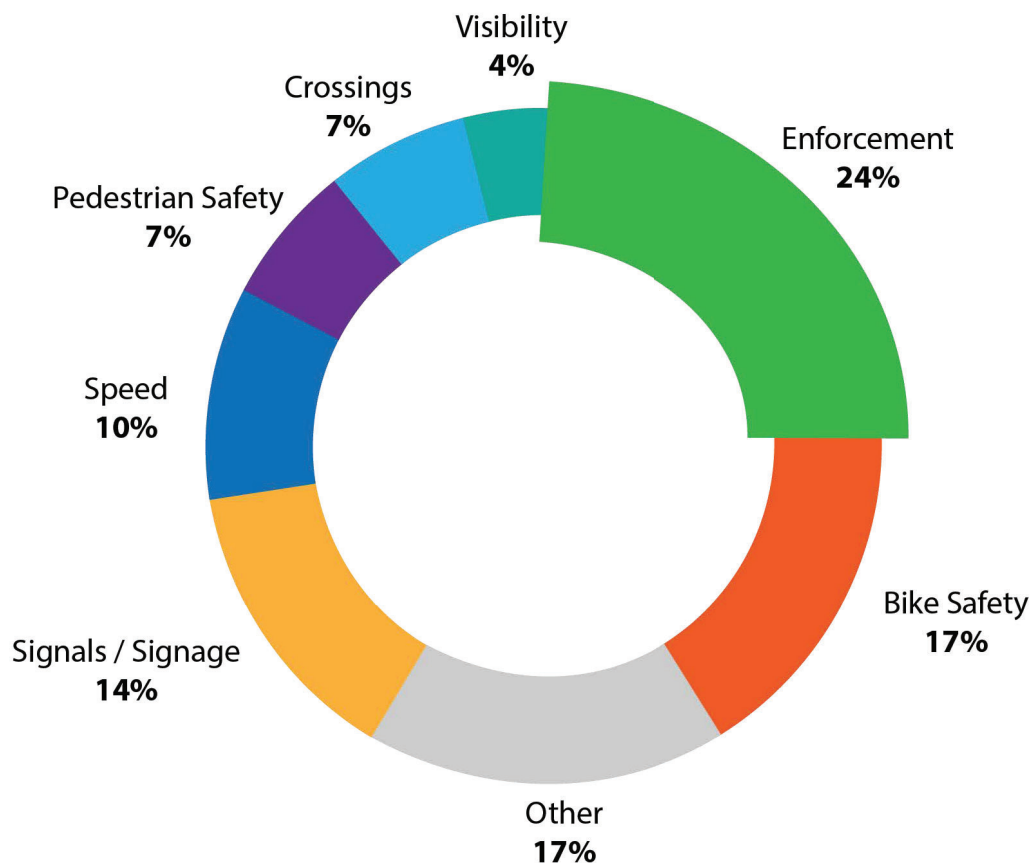

Comments received from post-it notes on project boards:

Signals / Signage

- I drive and walk. We need people to be more careful. They also need more lights along this corridor. South Stockton is very travelled because of all the schools along it.
- Fruitridge and 58th: One year ago, I got hit walking in the crosswalk on my light. Three-way stops and yields are unsafe because cars don't stop. We need more/longer crosswalk lights.
- People run red lights at McMahon.
- All red signal phase for pedestrians to cross.

Speed

- My grandma picks me up from school and there are a lot of fast cars.
- A road diet would help decrease car speeds.
- Drivers' speeds are too high.

Bike / Pedestrian Safety

- I just saw a car accident between a car and a bicycle - it happens all the time.
- I ride my bike all the time but won't shop on Stockton because it's unsafe.
- I won't ride my bike along this corridor because it feels unsafe.
- Connectivity of adjacent roads would make it easier to bike around.
- If there is enough room to put protected bike lanes in, that would be good.
- Pedestrian Safety
- I walk to school.
- My grandpa walks me to school sometimes and it doesn't feel safe, especially when there are a lot of people walking around.



Project team members discuss community experiences along the South Stockton corridor.



Nicole Porter, AIM Consulting, helping students make reflective stickers for their bike helmets.

Enforcement

- People don't respect the laws, especially drivers.
- There is a lot of red light running on Stockton / McMahon Drive - we need cameras!
- Many people don't see walkers.
- I was in an accident on South Stockton recently - I was stuck in traffic and someone merged into my lane without looking.
- Distracted driving from cell phones is an issue.
- Drivers don't pay attention. They are too concerned with going to their destination and not getting stuck in traffic.
- Drivers don't notice pedestrians, they turn without waiting.

Visibility

- Lemon Hill: lights are dim, and the sunset causes issues with visibility.

Crossings

- We need more crosswalks and stop lights on Stockton - I hear about too many crashes on the news.
- People cross in the middle of the street unexpectedly, especially at night.
- Other
- Lord have mercy! I avoid travelling on South Stockton at all costs.
- A lot of people get off the bus stop on McMahon, they walk onto South Stockton and could get hit.
- It's hard to exit stores on the South-west corner of Stockton / 47th. There is a popular food truck there.

Other

- I've never had trouble driving on South Stockton.
- Homeless on south Stockton – please get rid of them, they leave trash in my alley.



Florin

24th Street to Munson Way

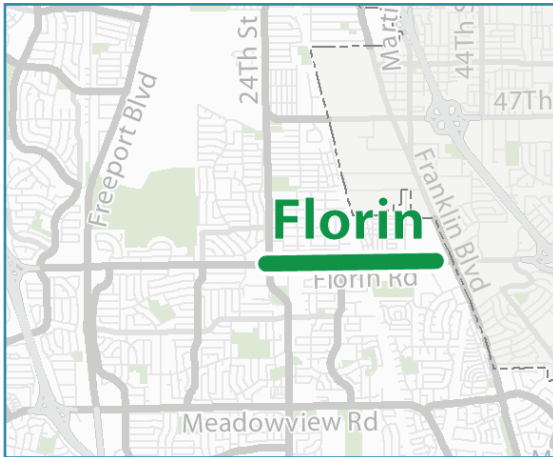

The project team held one community workshop to obtain community input on the Florin Corridor at Luther Burbank High School, on Thursday, November 15.

Below is the feedback received from the workshop distributed into relevant categories. The graph below depicts the amount of input received in each category.

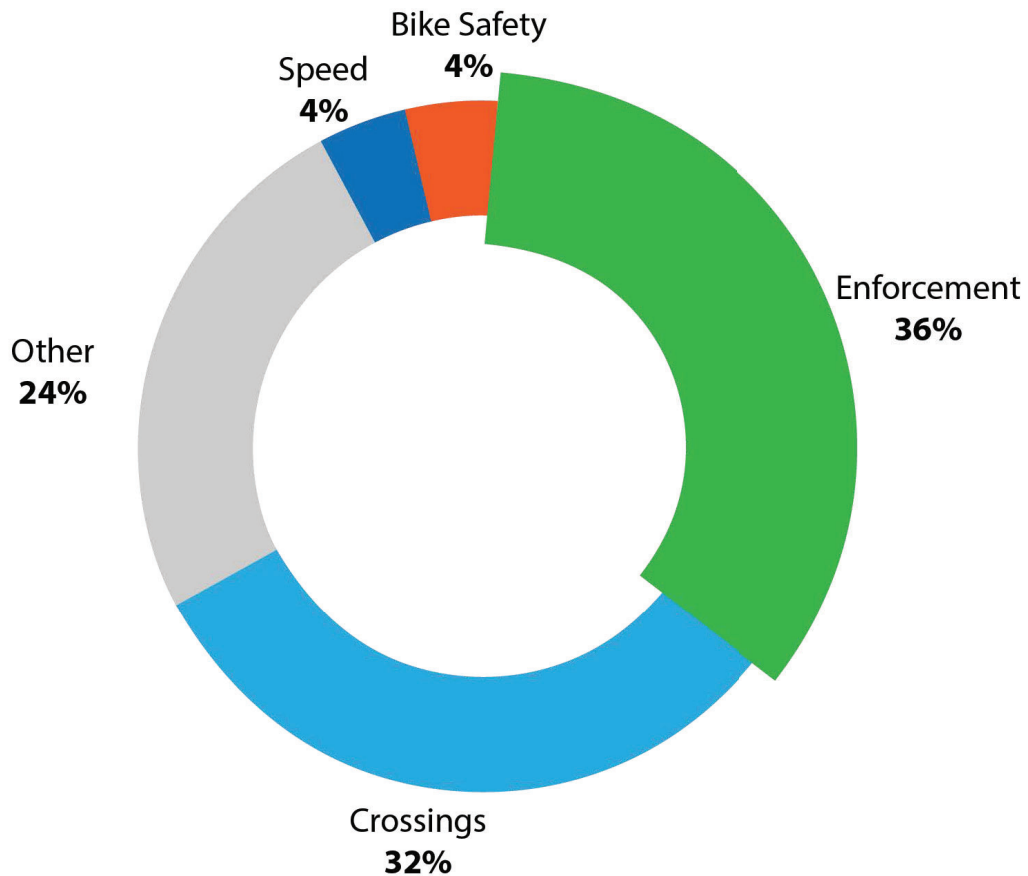

Comments received from post-it notes on project boards:

Speed

- Gates slow people down.

Crossings

- More crosswalks needed at light rail, with audible chirpers.
- Kids always cross mid-block at light rail, it needs a crossing.
- Pedestrian activated crosswalks needed.
- Loma Verde needs a cross walk and traffic signal.
- Students cross without a cross walk directly across from Luther Burbank entrance.
- The signals need more time for crossing (when seniors cross it is too short.)
- Luther Drive needs signals for walking across.
- It is difficult to walk by McDonald's on Florin Road. On Franklin and Florin, cars don't stop - we need more traffic control. Thick traffic gates on the road and reflective clothing would help.
- Morrison creek at Florin - the bus stops are in the traffic lanes and drivers are not thinking about pedestrians.

Enforcement

- We need to slow drivers down.
- Increase police enforcement of speeding and jay-walking.
- Florin has too much traffic and the speeds are too high.
- Stop signs: people don't actually stop, they only yield to stop signs.
- Police who see traffic violations are not addressing the violations.
- Drivers drive too fast.
- Red light running - needs more enforcement.
- Need more speed enforcement and better speed limit signs.

Bike Safety

- Need wider bike lanes.

Other

- I would rather take Uber than walk to school (Luther Burbank)
- Flooding at intersections, need DI improvements.
- More trees needed on Florin.
- Heard on NextDoor about the meeting.
- Make sure there are curb ramps for wheel chair users.
- Florin Road: I was contracted to tear up the median strip, assumed it was dirt under the asphalt. Found asphalt under the median strip, two lanes were in a ditch, and I was paid to destroy that.

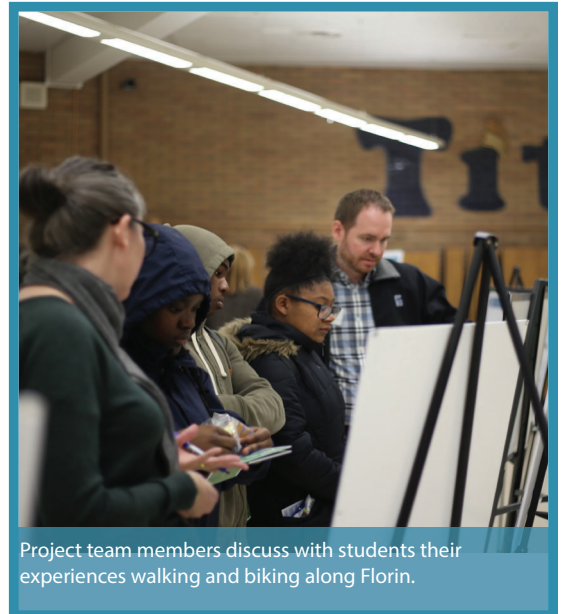

Project team members discuss with students their experiences walking and biking along Florin.

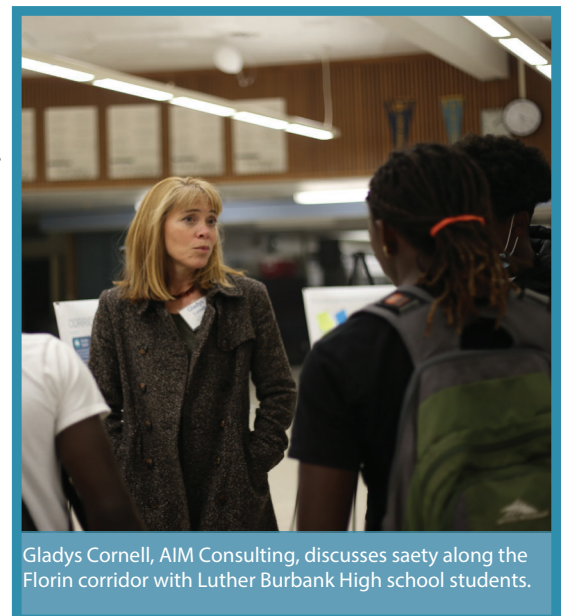

Gladys Cornell, AIM Consulting, discusses safety along the Florin corridor with Luther Burbank High school students.

Public Notification

The project team completed an extensive notification process for each pop-up event and community workshop. The purpose of creating and completing such an extensive notification plan was to inform the public about the project, it's goals, and ask community members who were notified to share the project and event information with their fellow communities.

For each event, a list of businesses, community associations, and individuals were notified by phone and email to share the event information with their organization along the adjacent corridor. A general email was also sent to all individuals who signed up throughout the City of Sacramento's email database for their specific corridor.

Below is a list of organizations and groups who helped share information about the project and events through email, social media, or printed flyer:

- Councilmember Allen Warren
- Councilmember Jay Schenirer
- Councilmember Larry Carr
- Councilmember Eric Guerra
- Florin Road Partnership
- Stockton Boulevard Partnership
- Sacramento City Blog
- Sacramento Are Bicycle Advocates (SABA)
- Southeast Village Neighborhood Association (SEVNA)
- Hagginwood Community Association
- North Sacramento United Methodist
- Smythe Academy for Arts and Sciences
- Harmon Elementary School
- Mutual Housing at River Garden
- Stanford Settlement
- Saint James Holy Baptist Church
- Friends of West Tahoe Park
- Elmhurst Neighborhood Association
- Colonial Heights Neighborhood Association
- William Lee College Prep
- Broadway DMV
- Parkwest Lotus Casino
- Sommerset Place Apartments
- Southeast Village Neighborhood Association
- Nicholas Elementary School
- Peter Burnett Elementary School
- SF Supermarket
- Rodeway Inn
- A&A Supermarket
- Smart & Final
- Southgate Plaza
- North Franklin District Business Association
- Florin Meadowview Apartments
- Southwind Mobile Estates
- Parkview Apartments
- Meadowview Neighborhood Association
- Luther Burbank High School
- Fern Bacon Middle School
- Bowling Green Elementary School
- Florin Square Shopping Center

Appendix

- Pop-up Boards
 - Project Overview Boards
 - Marysville
 - El Camino
 - Broadway / Stockton
 - South Stockton
 - Florin
- Comment Card
- Public Notification Flyers

Project Overview Boards



Where are the top five corridors?

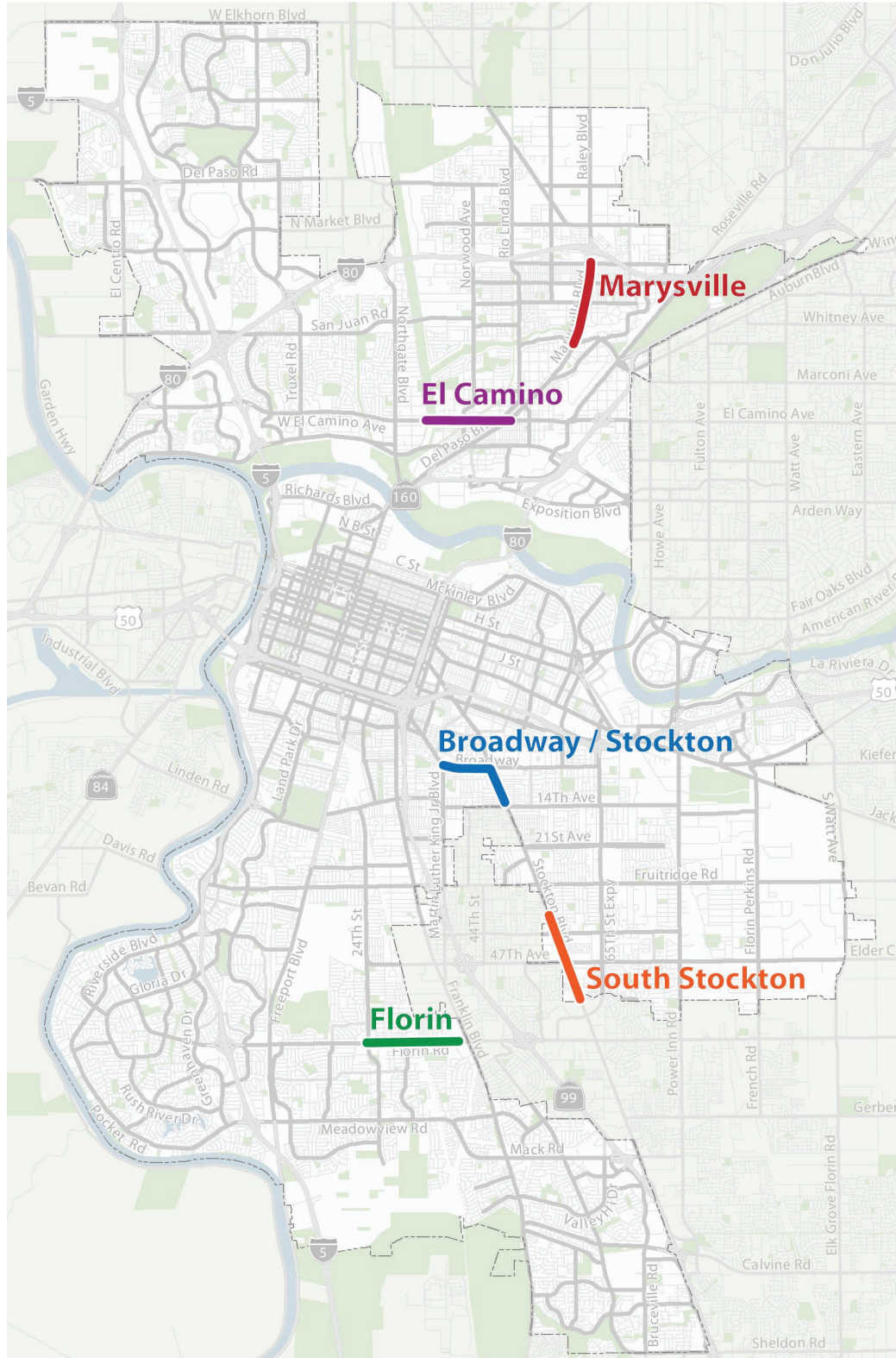

Marysville



MARYSVILLE BOULEVARD EXISTING CONDITIONS

IN THE MAP

- On-Street Bicycle Lane
- Distance Between Crosswalks

KEY CHARACTERISTICS

- SPEED LIMIT 35**
- Average Daily Traffic Volume: 26,300
- Class II bicycle lanes along most of the corridor
- Maximum distance between crosswalks: 2,550 ft between North Avenue and Bell Avenue
- 100% sidewalk coverage.

MARYSVILLE BOULEVARD SAMPLE CROSS-SECTION

Four travel lanes plus raised median/center turn lane.

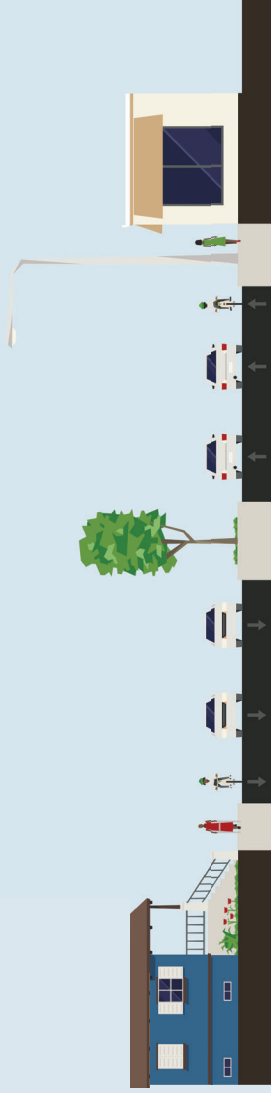

Source: StreetMw (CC BY-SA 4.0, <https://creativecommons.org/licenses/by-sa/4.0/>)

DAILY RIDERSHIP*

- 0 - 50
- 51 - 100
- 101 - 150
- Greater than 150

SACRT ROUTES COVERED:
15, 86

*Daily ridership is the sum of weekday boardings and alightings.

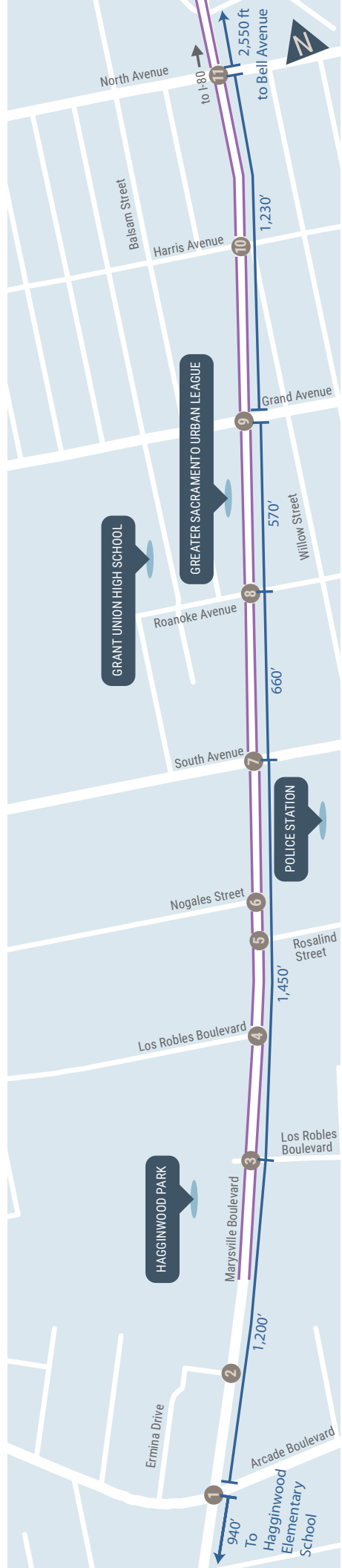
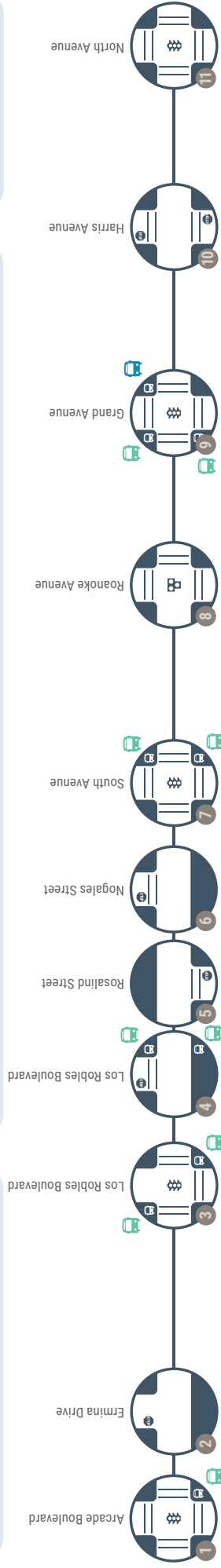

MARYSVILLE BOULEVARD CRASHES

CORRIDOR CRASH SUMMARY (2009-2017)



KEY CHARACTERISTICS

- SPEED LIMIT 35**
- Four travel lanes plus raised median/center turn lane.
- Class II bicycle lanes along most of the corridor.

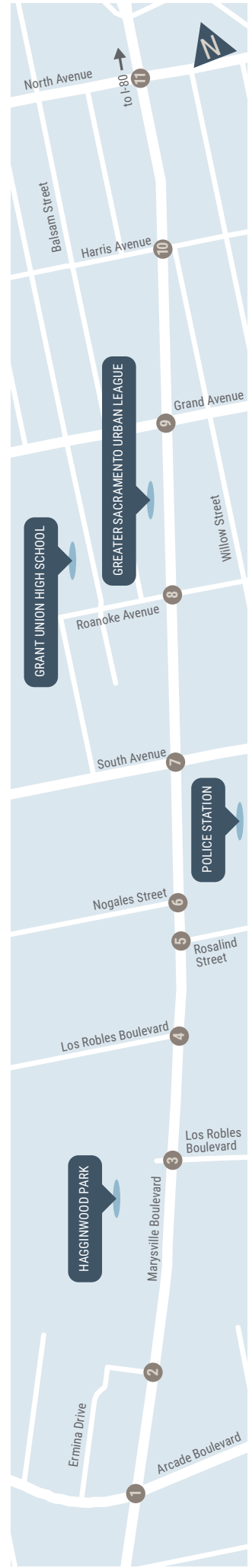
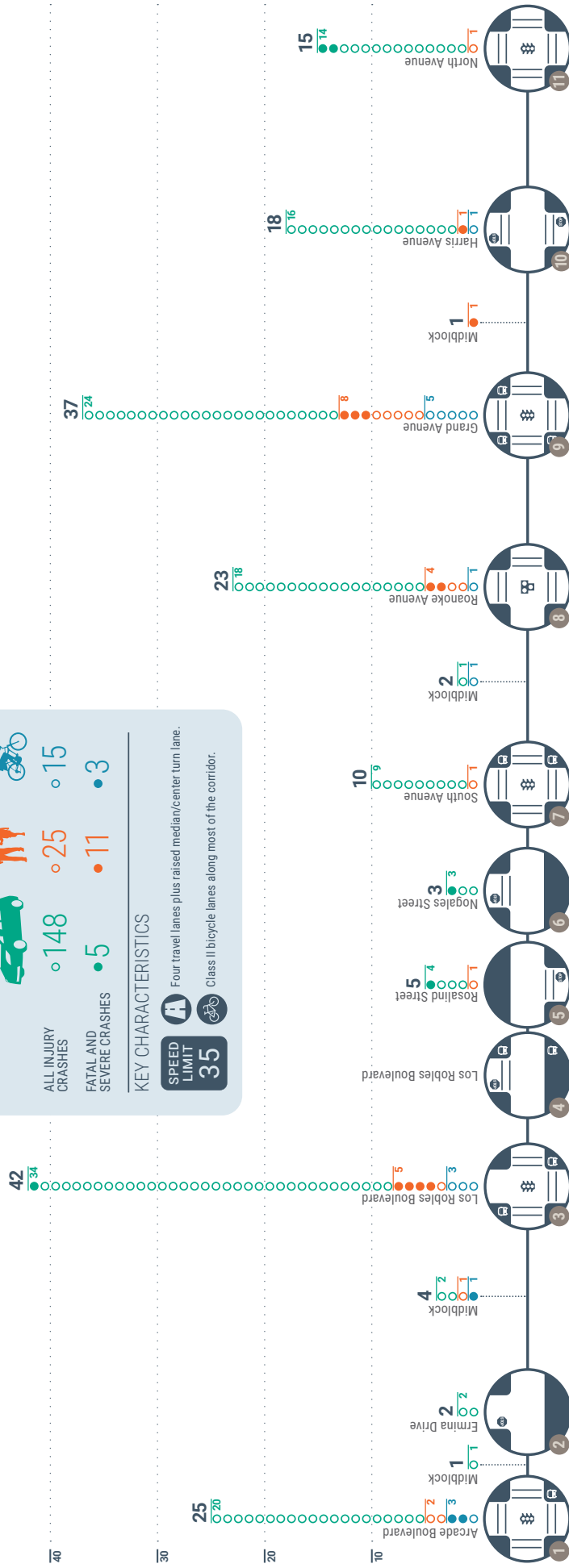

CORRIDOR-WIDE CRASH TYPES

VEHICLE

Unsafe Speed
 "Unsafe Speed" was cited as the primary violation in 20% of crashes.

1 2 3 4 5 6
7 8 9 10 11

Proceeding Straight
 2/3 of drivers were proceeding straight or stopped at the time of the crash.

1 2 3 4 5 6
7 8 9 10 11

Head On
 Nearly 20% of all crashes were head on.

1 2 3 4 5 6
7 8 9 10 11

KSI & Alcohol Involved
 Alcohol was involved in over half of crashes resulting in a fatality or severe injury.

1 2 3 4 5 6
7 8 9 10 11

Rear End
 Nearly 20% of all crashes were rear end.

1 2 3 4 5 6
7 8 9 10 11

Left Turns
 More than 20% of drivers were making a left turn at the time of the crash.

1 2 3 4 5 6
7 8 9 10 11

Broadside
 40% of all crashes were broadside, also called T-Bone.

1 2 3 4 5 6
7 8 9 10 11

PEDESTRIAN

Pedestrian Crossing
 Almost all people hit while walking were crossing. 2/3 of people were in the crosswalk.

1 2 3 4 5 6
7 8 9 10 11

Nighttime
 Half of pedestrian crashes occurred during nighttime or dark conditions.

1 2 3 4 5 6
7 8 9 10 11

BICYCLE

Broadside
 3/4 of bicycle crashes were broadside, also called T-Bone.

1 2 3 4 5 6
7 8 9 10 11

1 Numbers that are turned on represent a location where crash type has occurred at least three times.

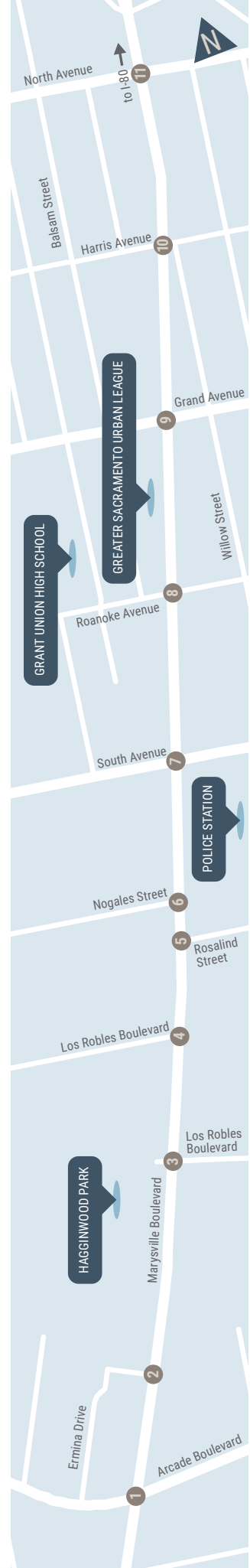
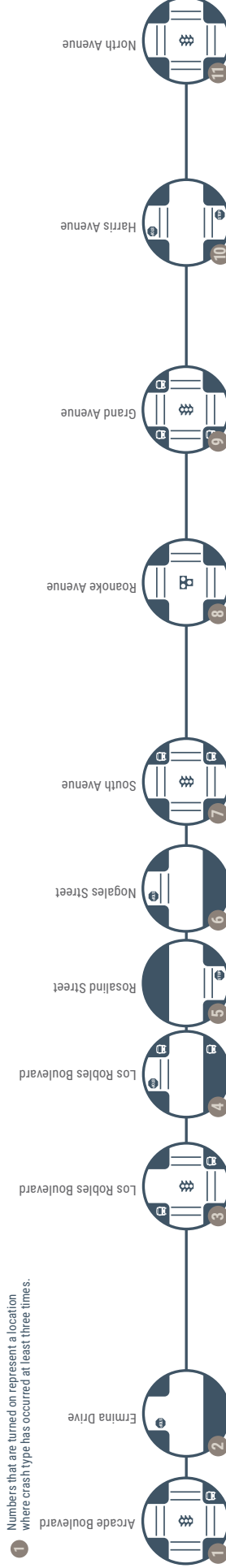

Tell us about your experience traveling along Marysville Boulevard:

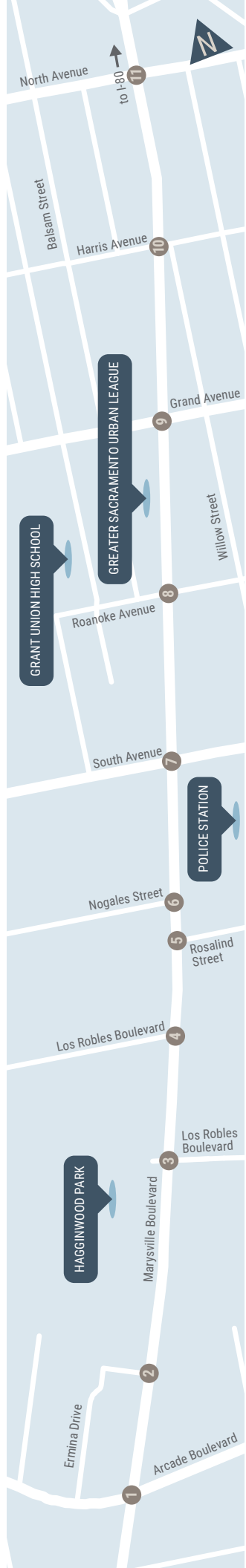

El Camino



EL CAMINO AVENUE - EXISTING CONDITIONS

IN THE MAP

- On-Street Bicycle Lane
- Distance Between Crosswalks
- Multi-Use Path
- Sidewalk Gap

KEY CHARACTERISTICS

- SPEED LIMIT 30**
- Average Daily Traffic Volume: 13,500
- Class II bicycle lanes along most of the corridor.
- Maximum distance between crosswalks: 2,100 ft between American Ave & Colfax Ave
- 97% sidewalk coverage.

EL CAMINO AVENUE SAMPLE CROSS-SECTION

One travel lane in each direction.

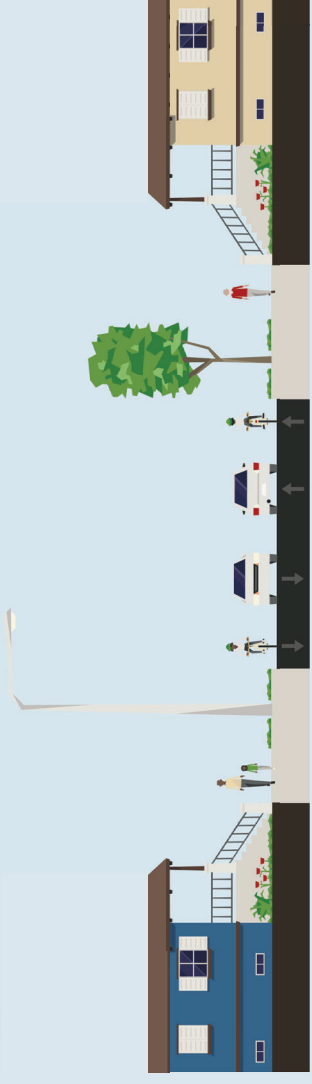

Source: StreetMkr (CC BY-SA 4.0, <https://creativecommons.org/licenses/by-sa/4.0/>)

DAILY RIDERSHIP*

- 0 - 50
- 51 - 100
- 101 - 150
- Greater than 150

SACRT ROUTES COVERED:

15, 88

*Daily ridership is the sum of weekday boardings and alightings.

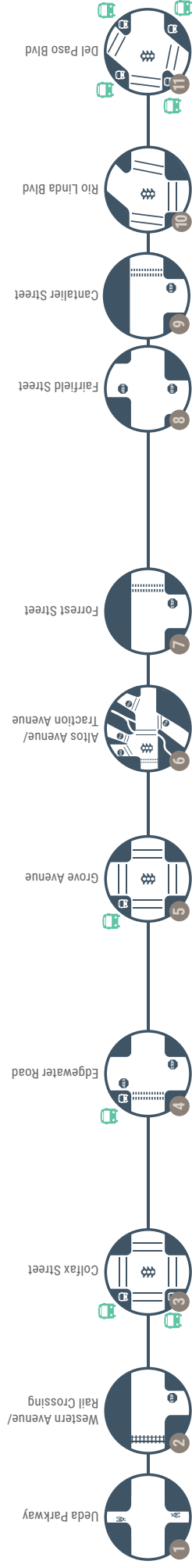

EL CAMINO AVENUE CRASHES

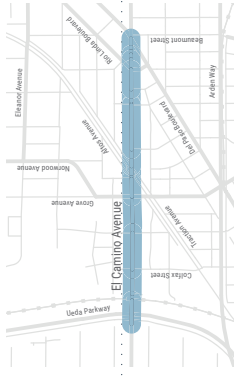

CORRIDOR CRASH SUMMARY (2009-2017)

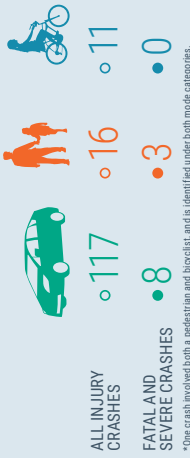

KEY CHARACTERISTICS

- 30** SPEED LIMIT
- One travel lane in each direction.
- Class II bicycle lanes along most of the corridor.

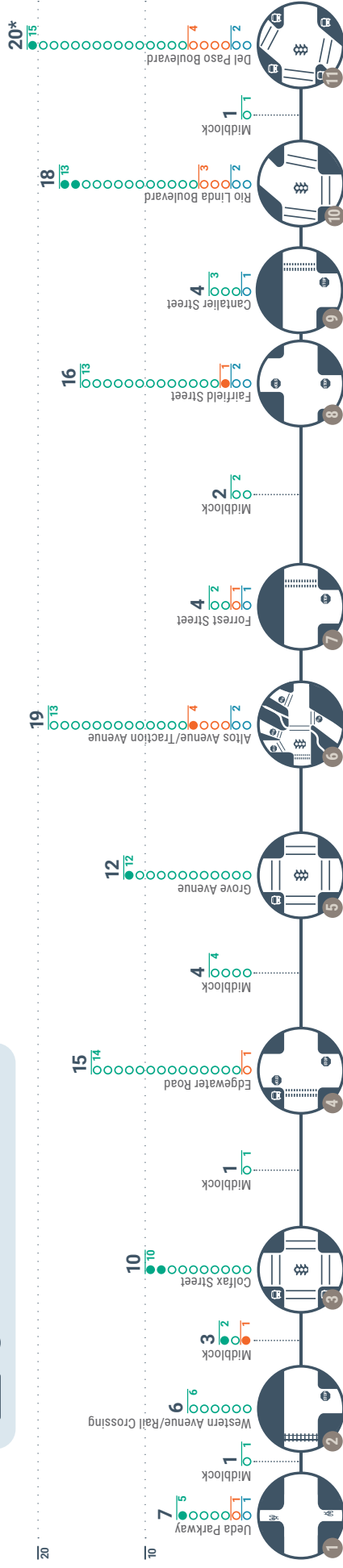

CORRIDOR-WIDE CRASH TYPES

VEHICLE

Unsafe Speed

"Unsafe Speed" was the most common violation, cited in 40% of all crashes.

1 2 3 4 5 6
7 8 9 10 11

Proceeding Straight

80% of drivers were proceeding straight or stopped at the time of the crash.

1 2 3 4 5 6
7 8 9 10 11

Signal or Sign Violation

"Traffic Signals and Signs" was the second most common violation category.

1 2 3 4 5 6
7 8 9 10 11

Rear End

Over 40% of all crashes were rear end.

1 2 3 4 5 6
7 8 9 10 11

Left Turns

70% of drivers who were turning at the time of the crash were making a left turn.

1 2 3 4 5 6
7 8 9 10 11

Broadside

30% of all crashes were broadside, also called T-Bone.

1 2 3 4 5 6
7 8 9 10 11

PEDESTRIAN

Pedestrian Crossing

The majority of people hit while walking were in the crosswalk.

1 2 3 4 5 6
7 8 9 10 11

Weekend

Nearly 2/3 of pedestrian crashes occurred on Friday, Saturday or Sunday.

1 2 3 4 5 6
7 8 9 10 11

BICYCLE

Daytime

10 of 11 total bicycle crashes occurred between 9 AM and 6 PM.

1 2 3 4 5 6
7 8 9 10 11

1 Numbers that are turned on represent a location where crash type has occurred at least three times.

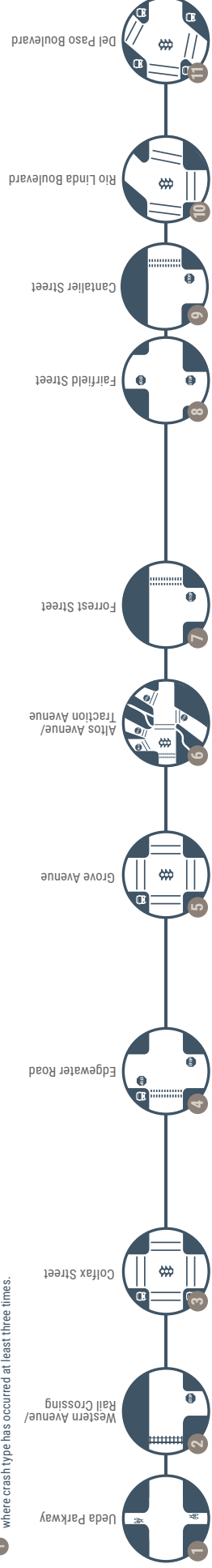

Broadway / Stockton



BROADWAY - EXISTING CONDITIONS

IN THE MAP

- On-Street Bicycle Lane
- Distance Between Crosswalks

KEY CHARACTERISTICS

- SPEED LIMIT 30**
- Average Daily Traffic Volume: 15,800
- Class II bicycle lanes on some of corridor
- Maximum distance between crosswalks: 930 ft between 39th Street & Santa Cruz Way
- 100% sidewalk coverage

BROADWAY SAMPLE CROSS-SECTION

Four travel lanes with some left turn pockets.

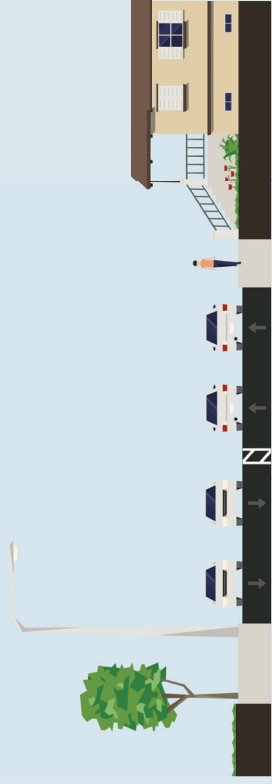

Source: StreetMik (CC BY-SA 4.0, <https://creativecommons.org/licenses/by-sa/4.0/>)

DAILY RIDERSHIP*

- 0 - 50
- 51 - 100
- 101 - 150
- Greater than 150

SACRT ROUTES COVERED:
51, 206, 214

*Daily ridership is the sum of weekday boardings and alightings.

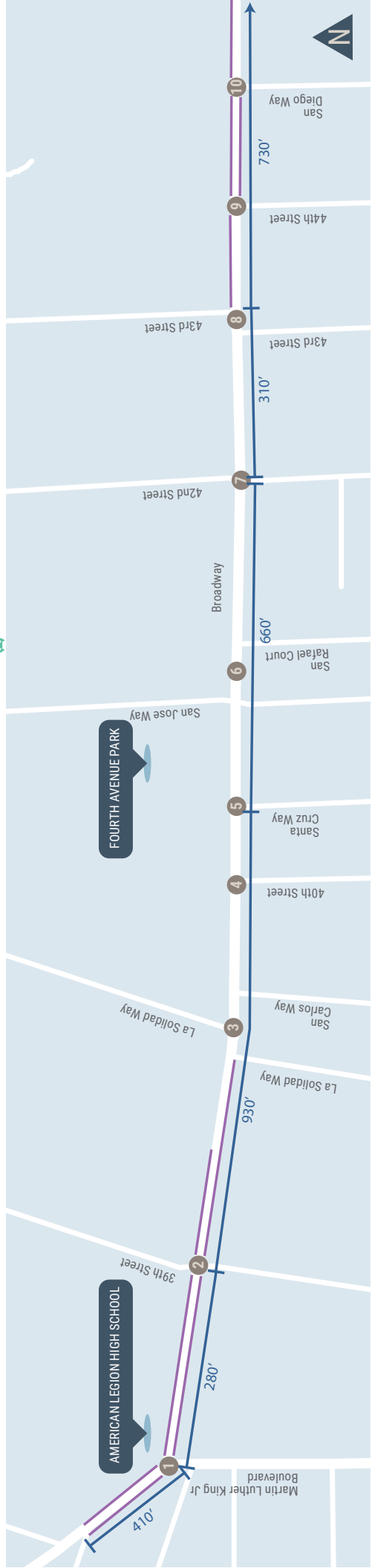
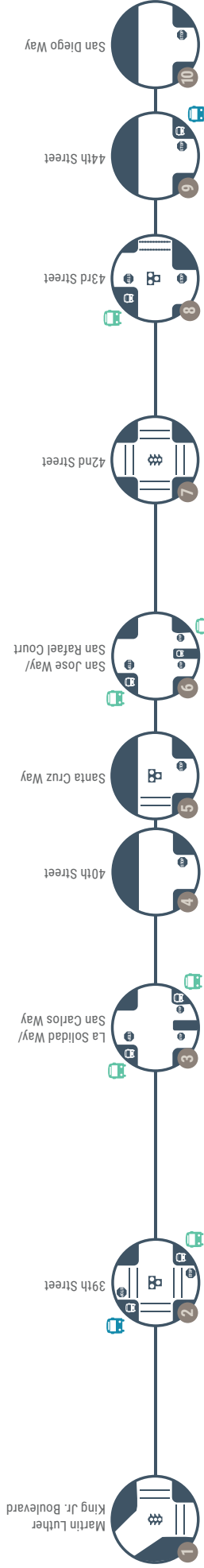

BROADWAY CRASHES

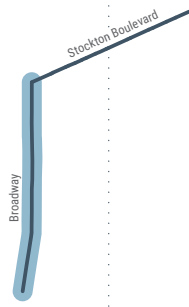

CORRIDOR CRASH SUMMARY (2009-2017)

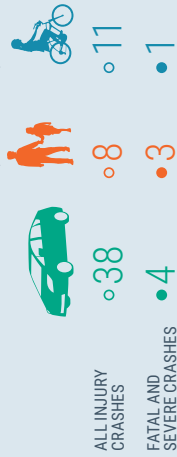

- SPEED LIMIT 30**
- 1** Four travel lanes with some left turn pockets.
- 2** Class II bicycle lanes along short portions of the corridor.

10
Martin Luther King Jr. Boulevard

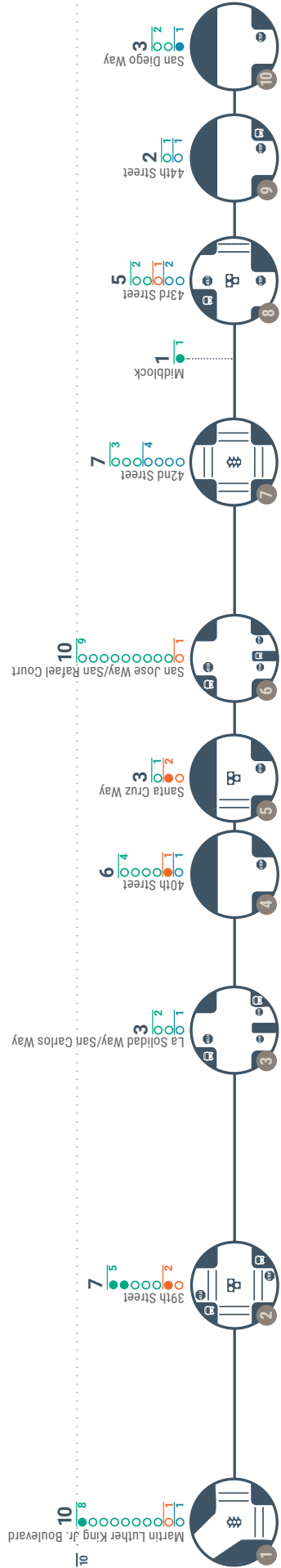

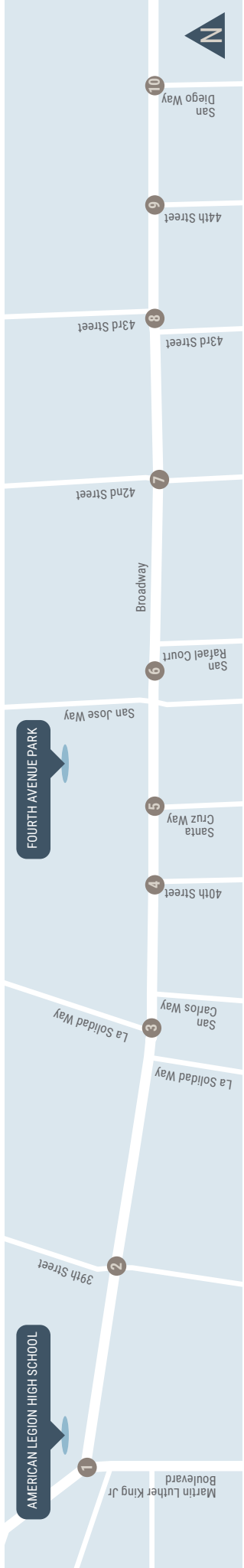

1
AMERICAN LEGION HIGH SCHOOL





CORRIDOR-WIDE CRASH TYPES

VEHICLE

Unsafe Speed

 "Unsafe Speed" was the most common violation, cited in 28% of all crashes.
 1 2 3 4 5 6
 7 8 9 10

Proceeding Straight

 More than 2/3 of drivers were proceeding straight or stopped at the time of the crash.
 1 2 3 4 5 6
 7 8 9 10

Sideswipe

 Sideswipe was the second most common crash type - 23% of all crashes.
 1 2 3 4 5 6
 7 8 9 10

Not in Crosswalk

 Half of pedestrians hit were crossing outside of a crosswalk at the time of the crash.
 1 2 3 4 5 6
 7 8 9 10

Weekend

 Nearly 2/3 of pedestrian crashes occurred on Friday or Saturday.
 1 2 3 4 5 6
 7 8 9 10

Rear End

 Rear End was the most common crash type - 25% of all crashes.
 1 2 3 4 5 6
 7 8 9 10

Left Turns

 Nearly 2/3 of drivers who were turning at the time of the crash were making a left turn.
 1 2 3 4 5 6
 7 8 9 10

Broadside

 Nearly 20% of all crashes were broadside, also called T-Bone.
 1 2 3 4 5 6
 7 8 9 10

Daytime

 Nearly 2/3 of pedestrian crashes occurred between 6 AM and 6 PM.
 1 2 3 4 5 6
 7 8 9 10

Improper Turning

 "Improper Turning" was cited as the primary violation in nearly half of bike crashes.
 1 2 3 4 5 6
 7 8 9 10

BICYCLE

Sideswipe

 45% of bicycle crashes were sideswipe.
 1 2 3 4 5 6
 7 8 9 10

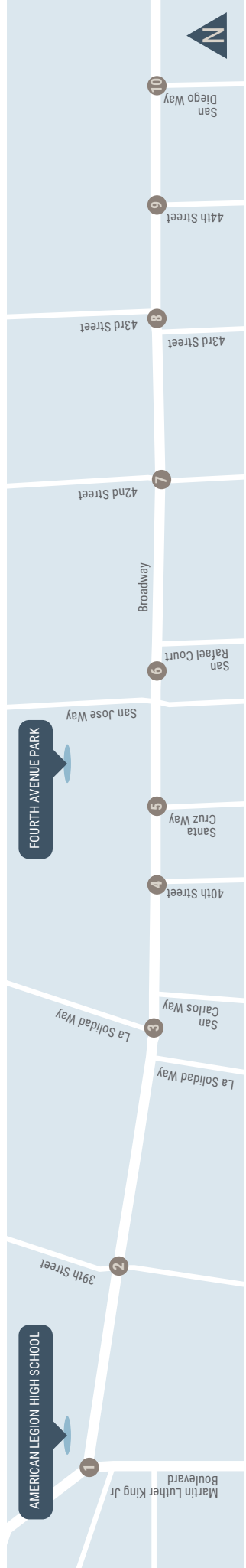
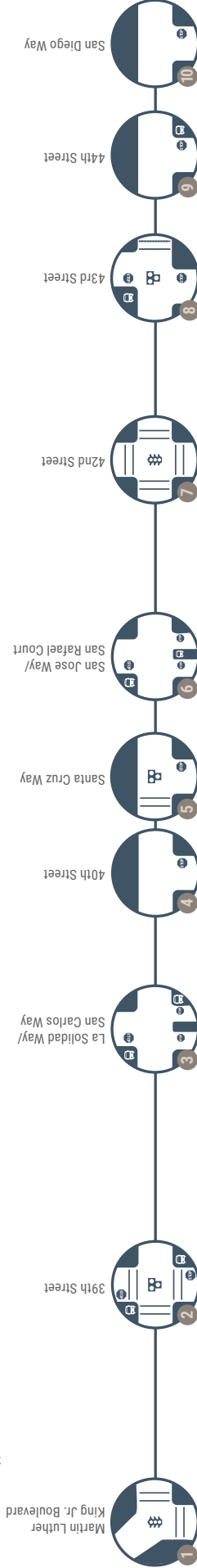
1 Numbers that are turned on represent a location where crash type has occurred at least three times.

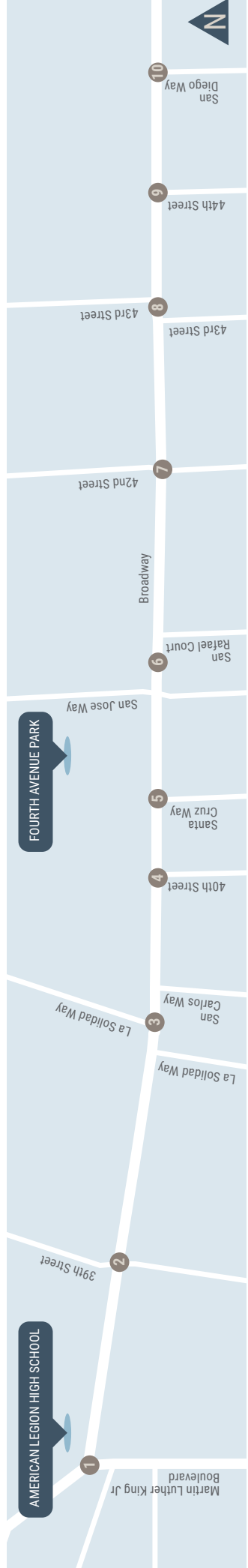
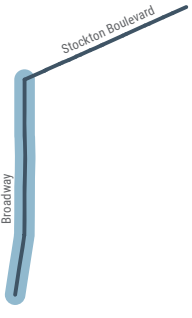

Tell us about your experience traveling along Broadway:



STOCKTON BOULEVARD - EXISTING CONDITIONS

IN THE MAP

- On-Street Bicycle Lane
- Distance Between Crosswalks

STOCKTON BOULEVARD SAMPLE CROSS-SECTION
Four travel lanes plus raised median/center turn lane.

Source: StreetMx (CC BY-SA 4.0, <https://creativecommons.org/licenses/by-sa/4.0/>)

DAILY RIDERSHIP*

- 0 - 50
- 51 - 100
- 101 - 150
- Greater than 150

SACRT ROUTES COVERED:
51, 213

*Daily ridership is the sum of weekday boardings and alightings.

KEY CHARACTERISTICS

- Average Daily Traffic Volume: 19,600
- Class II bicycle lanes along the entire corridor
- Maximum distance between crosswalks: 1,560 feet between Broadway and 2nd Avenue
- 100% sidewalk coverage

SPEED LIMIT
35

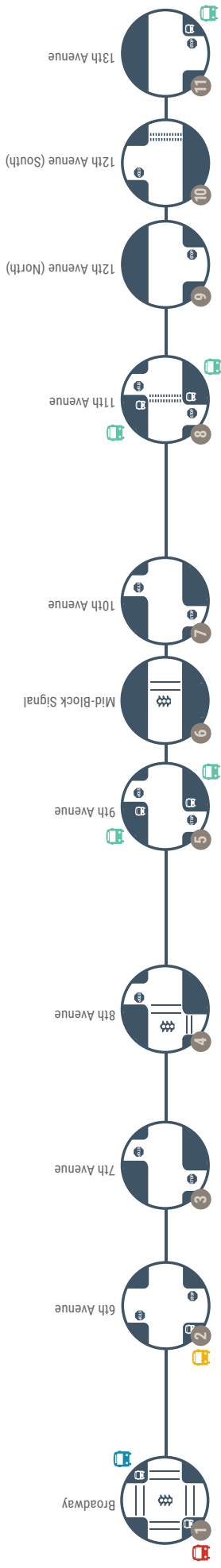

STOCKTON BOULEVARD CRASHES

60

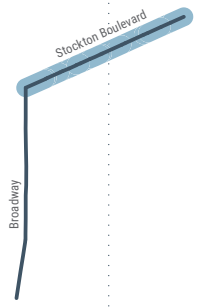

CORRIDOR CRASH SUMMARY (2009-2017)

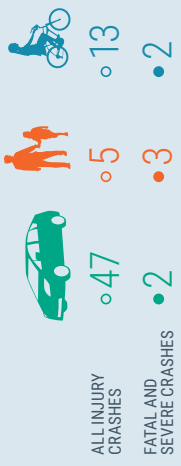

KEY CHARACTERISTICS

- A** Four travel lanes plus raised median/center turn lane.
- B** Class II bicycle lanes along entire corridor.

SPEED LIMIT 35

34

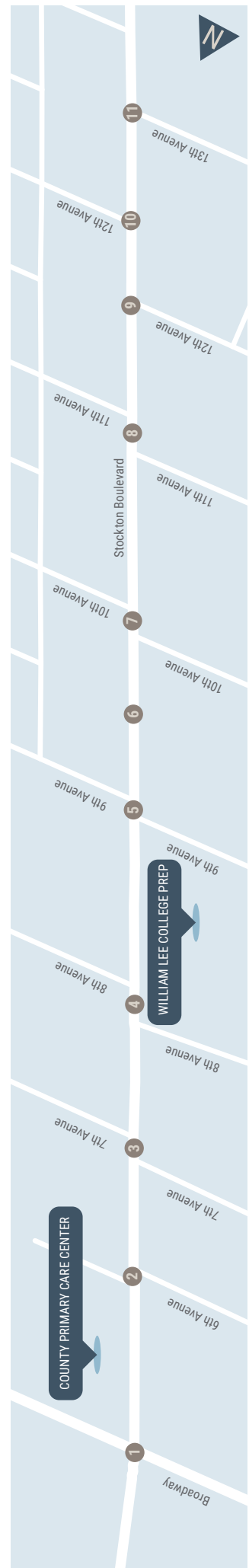
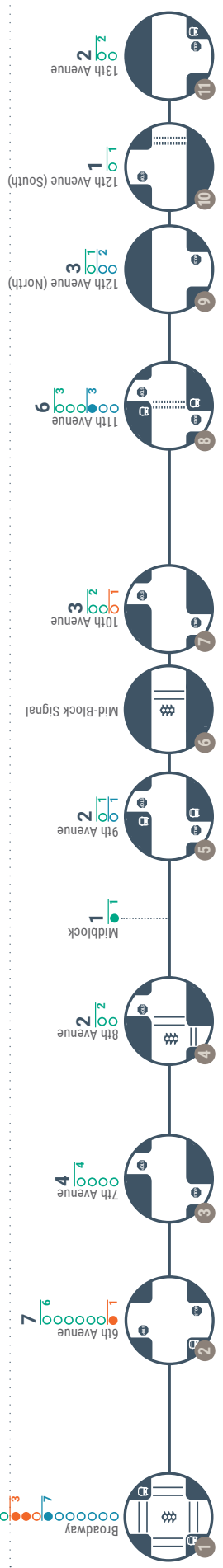

CORRIDOR-WIDE CRASH TYPES

VEHICLE

Unsafe Speed



"Unsafe Speed" was the primary violation cited in 23% of all crashes.

1 2 3 4 5 6
7 8 9 10 11

Proceeding Straight



More than 60% of drivers were proceeding straight or stopped at the time of the crash.

1 2 3 4 5 6
7 8 9 10 11

Broadside



40% of all crashes were broadside, also called T-Bone.

1 2 3 4 5 6
7 8 9 10 11

Crossing in Crosswalk



60% of pedestrians hit by drivers were crossing in a crosswalk at the time of the crash.

1 2 3 4 5 6
7 8 9 10 11

PEDESTRIAN

Broadside



More than 60% of bicycle crashes were broadside, also called T-Bone.

1 2 3 4 5 6
7 8 9 10 11

Morning



More than 60% of bicycle crashes occurred before noon.

1 2 3 4 5 6
7 8 9 10 11

Rear End



Rear End was the second most common crash type - 20% of all crashes.

1 2 3 4 5 6
7 8 9 10 11

Left Turns



More than 70% of drivers who were turning at the time of the crash were making a left turn.

1 2 3 4 5 6
7 8 9 10 11

Senior Victims



60% of pedestrian victims were age 60 or older.

1 2 3 4 5 6
7 8 9 10 11

Right Turns



In nearly half of bike crashes, the driver was making a right turn.

1 2 3 4 5 6
7 8 9 10 11

1 Numbers that are turned on represent a location where crash type has occurred at least three times.

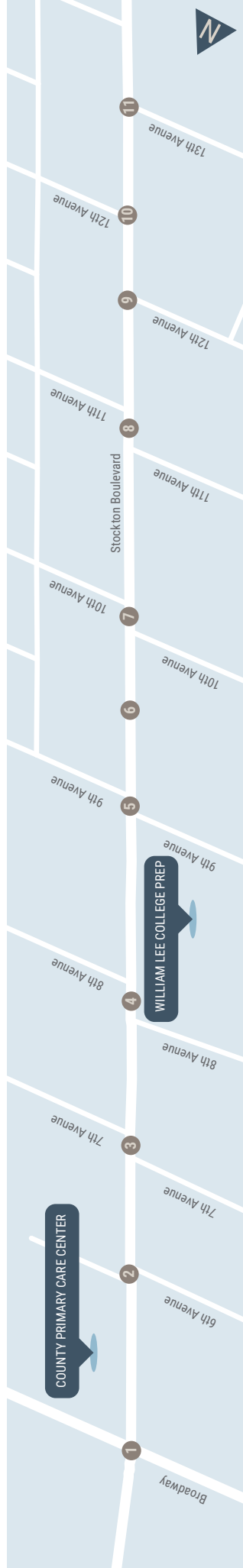
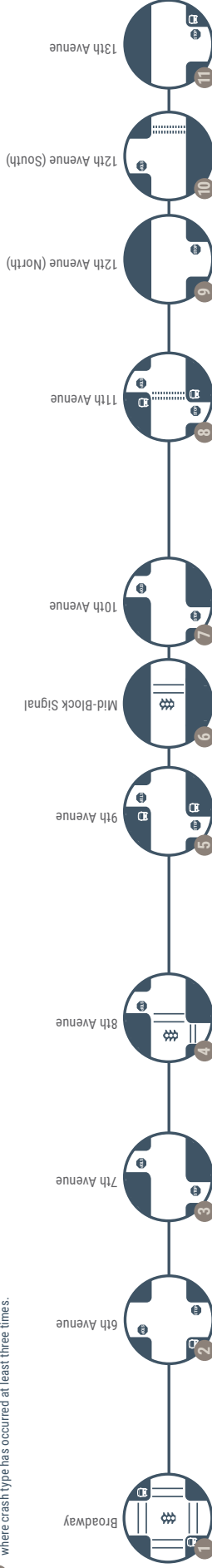

Tell us about your experience traveling along Stockton Boulevard:

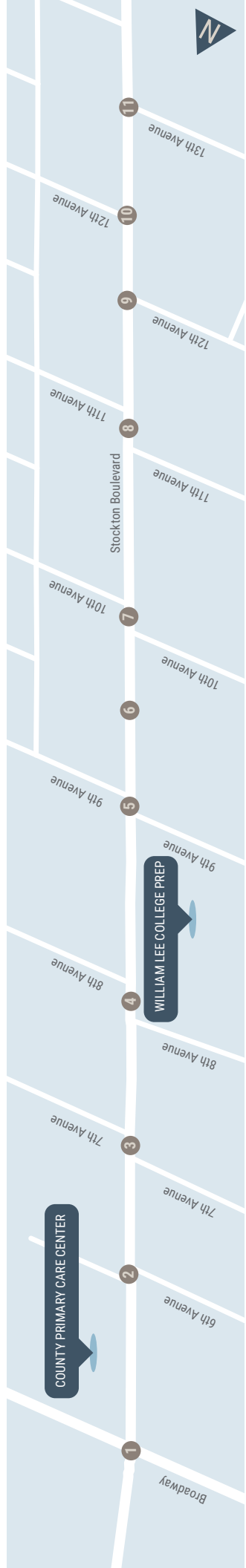
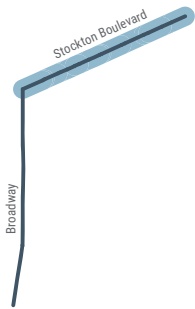

South Stockton



STOCKTON BOULEVARD - EXISTING CONDITIONS

IN THE MAP

- On-Street Bicycle Lane
- Sidewalk Gap
- Distance Between Crosswalks

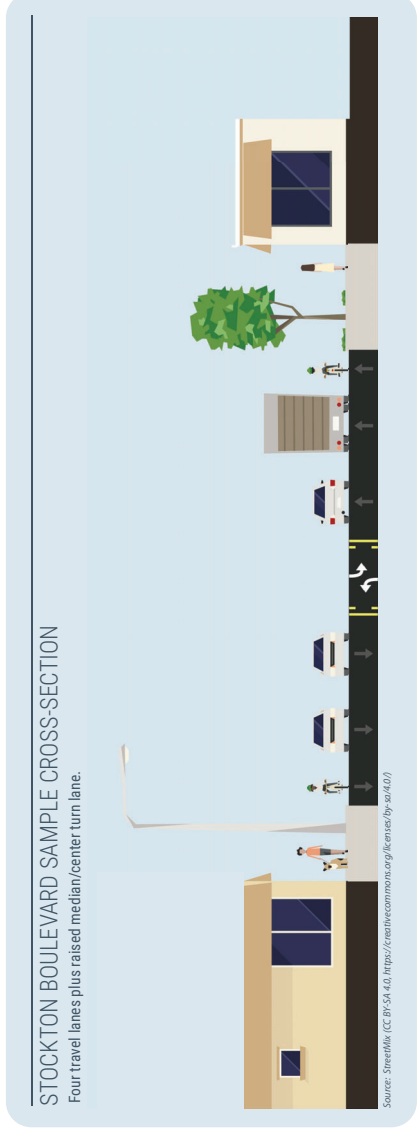

DAILY RIDERSHIP*

- 0 - 50
- 51 - 100
- 101 - 150
- Greater than 150

SACRT ROUTES COVERED: 51

*Daily ridership is the sum of weekday boardings and alightings.

KEY CHARACTERISTICS

- Average Daily Traffic Volume: 29,700
- Class II bicycle lanes along the entire corridor.
- Maximum distance between crosswalks: 1,780 ft between Riza Avenue and 65th Street
- 97% sidewalk coverage.

SPEED LIMIT 40

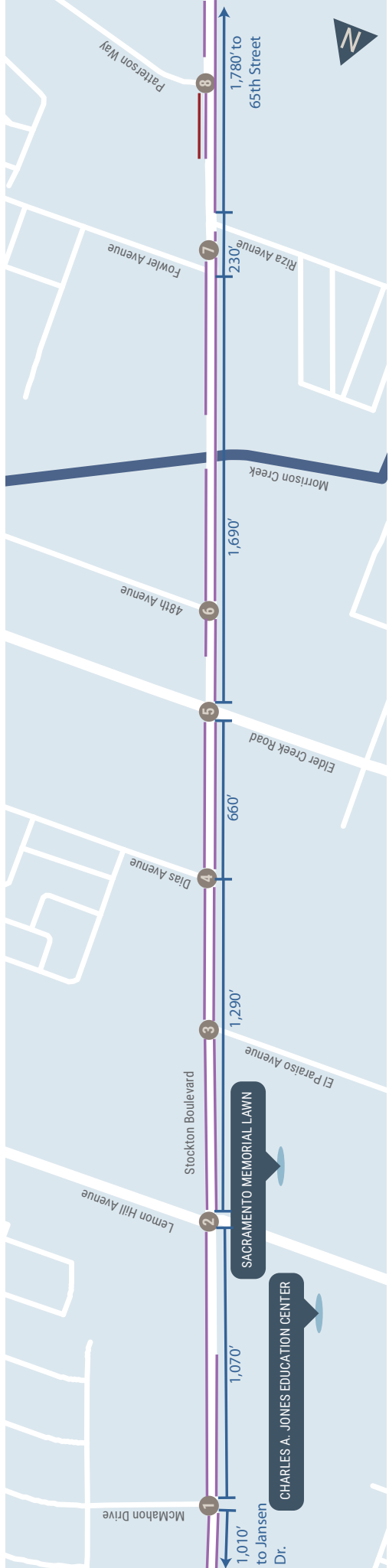
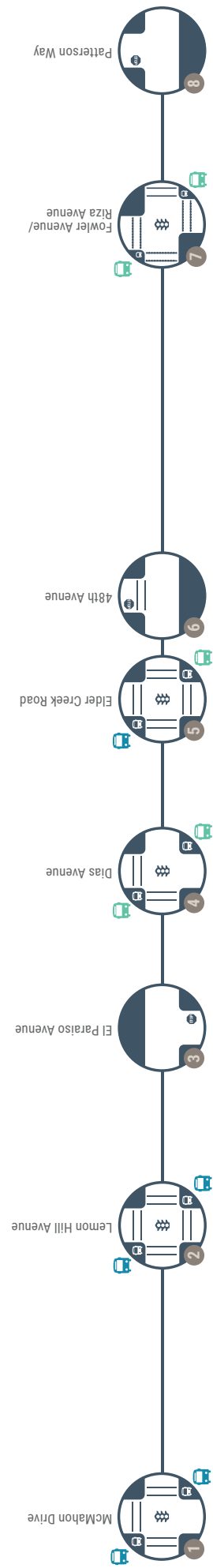

STOCKTON BOULEVARD CRASHES

CORRIDOR CRASH SUMMARY (2009-2017)

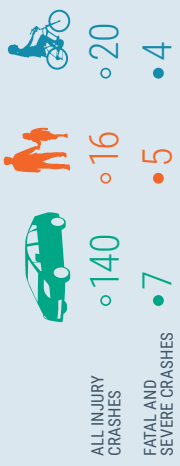

KEY CHARACTERISTICS

- SPEED LIMIT 40
- Class II bicycle lanes along the entire corridor.
- Four travel lanes plus raised median/center-turn lane.

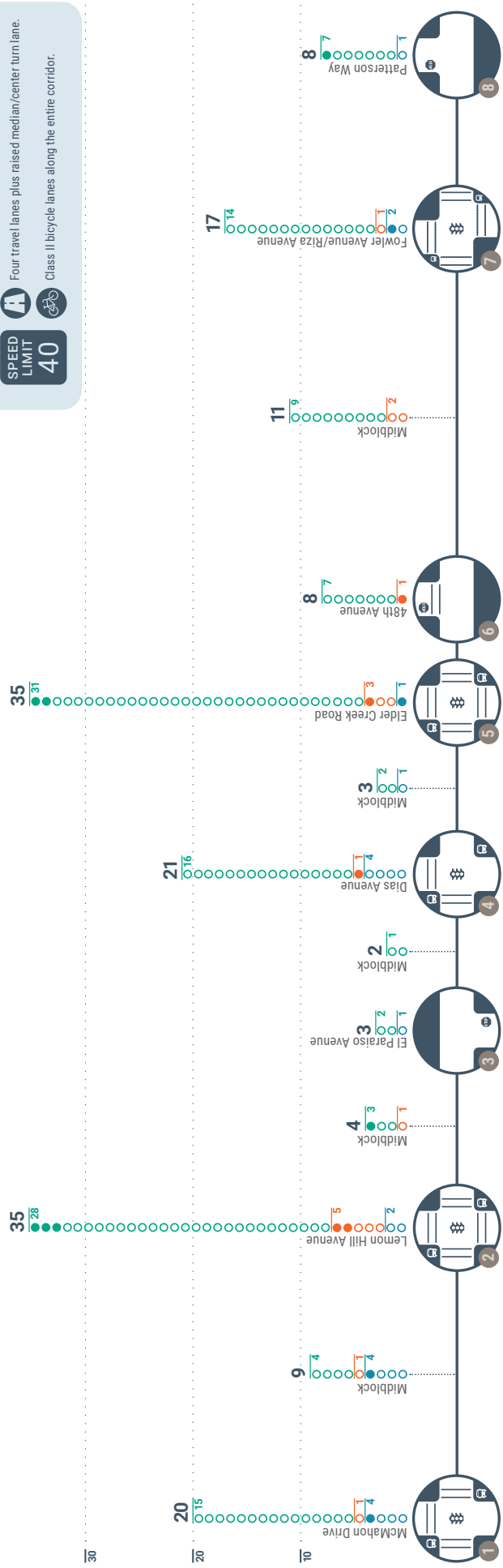

CORRIDOR-WIDE CRASH TYPES

VEHICLE

Unsafe Speed

"Unsafe Speed" was the most common violation, cited in 35% of all crashes.

1 2 3 4 5 6
7 8

Proceeding Straight

Nearly 3/4 of drivers were proceeding straight or stopped at the time of the crash.

1 2 3 4 5 6
7 8

Signal or Sign Violation

"Traffic Signals and Signs" was tied for second most common violation category.

1 2 3 4 5 6
7 8

Under the Influence

"Under the Influence" was tied for second most common violation category.

1 2 3 4 5 6
7 8

Rear End

Over 35% of all crashes were rear end.

1 2 3 4 5 6
7 8

Left Turns

65% of drivers who were turning at the time of the crash were making a left turn.

1 2 3 4 5 6
7 8

Broadside

30% of all crashes were broadside, also called T-Bone.

1 2 3 4 5 6
7 8

Nighttime

40% of all crashes occurred during nighttime or dark conditions.

1 2 3 4 5 6
7 8

PEDESTRIAN

Crossing in Crosswalk

Nearly half of all pedestrians hit by a driver were in a crosswalk at the time of the crash.

1 2 3 4 5 6
7 8

Pedestrian in Road

25% of pedestrians hit by a driver were walking along the road or shoulder.

1 2 3 4 5 6
7 8

BICYCLE

Broadside

65% of bicycle crashes were broadside, also called T-Bone.

1 2 3 4 5 6
7 8

Right Turns

1/3 of drivers who hit a bicyclist were making a right turn at the time of the crash.

1 2 3 4 5 6
7 8

1 Numbers that are turned on represent a location where crash type has occurred at least three times.

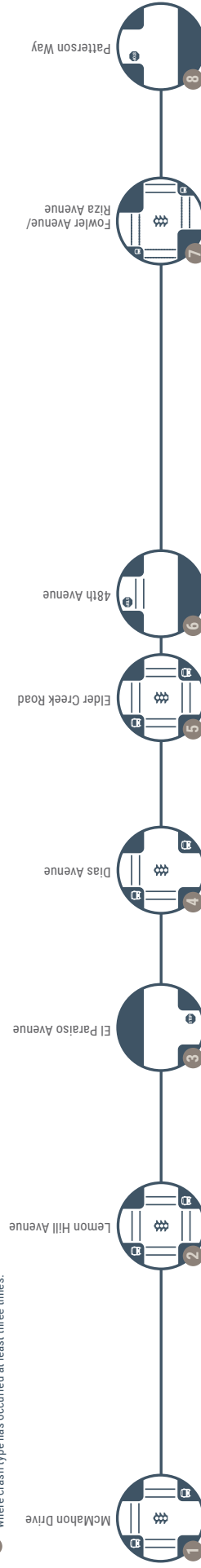

Tell us about your experience traveling along Stockton Boulevard:

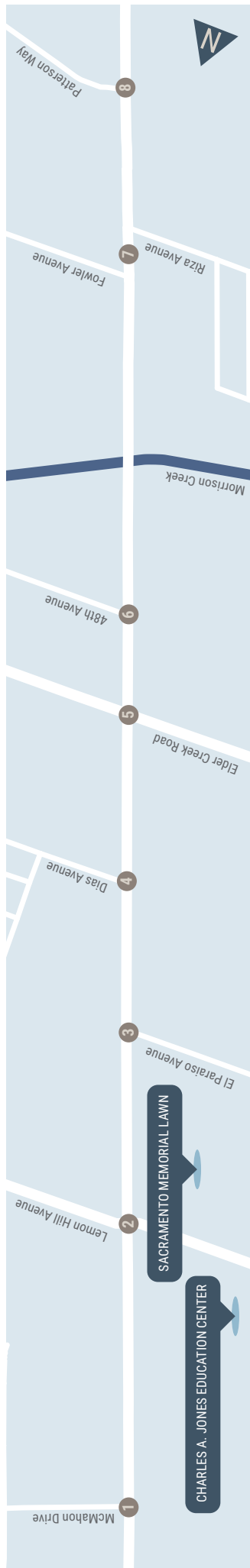

Florin

FLORIN ROAD - EXISTING CONDITIONS

IN THE MAP

- On-Street Bicycle Lane
- Distance Between Crosswalks

KEY CHARACTERISTICS

- SPEED LIMIT 40**
- Average Daily Traffic Volume: 36,000
- Class II bicycle lanes present in some locations.
- Maximum distance between crosswalks: 1,740 ft.
- 100% sidewalk coverage.

FLORIN ROAD SAMPLE CROSS-SECTION

Four travel lanes plus raised median/center turn lane.

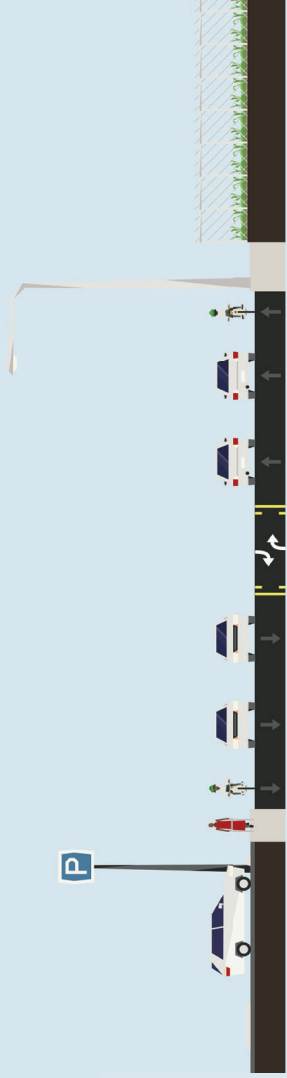

Source: StreetMia (CC BY-SA 4.0) <https://creativecommons.org/licenses/by-sa/4.0/>

DAILY RIDERSHIP*

- 0 - 50
- 51 - 100
- 101 - 150
- Greater than 150

SACRT ROUTES COVERED:
54, 81

*Daily ridership is the sum of weekday boardings and alightings.

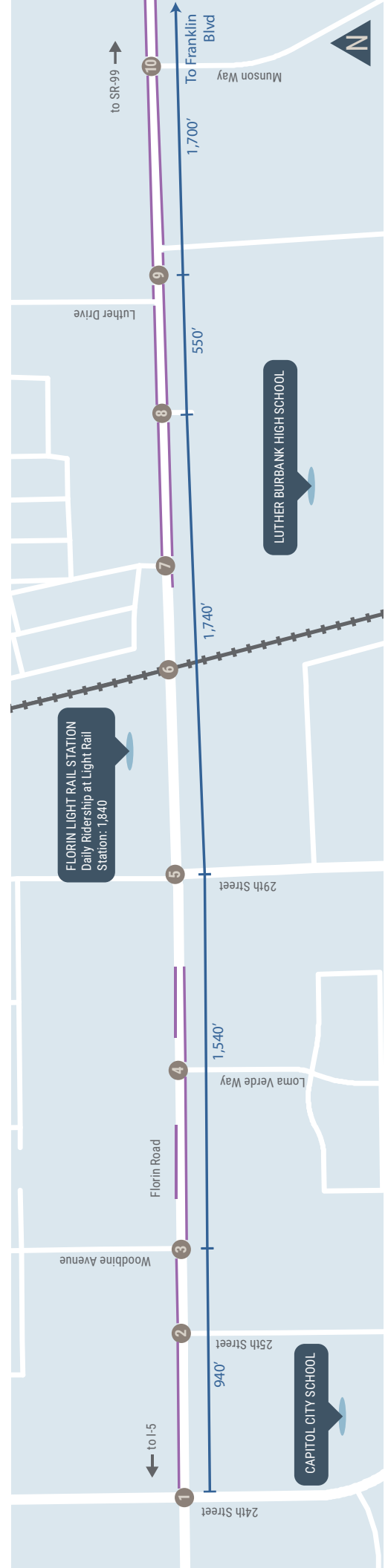
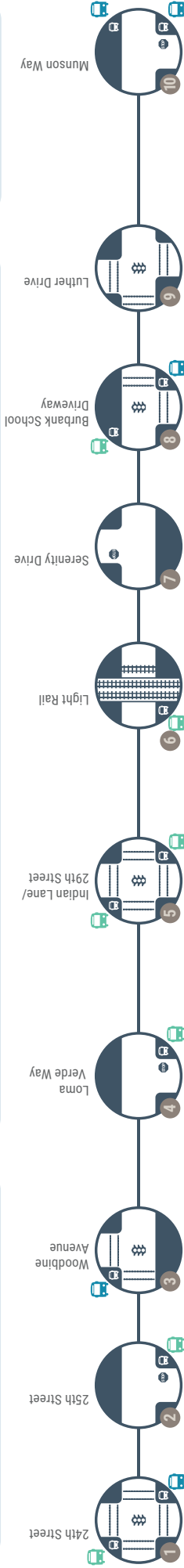

FLORIN ROAD CRASHES

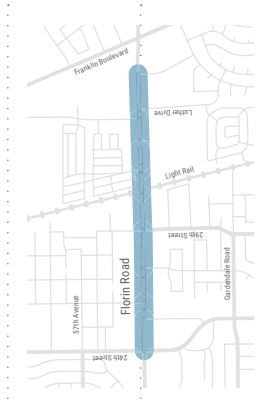

CORRIDOR CRASH SUMMARY (2009-2017)

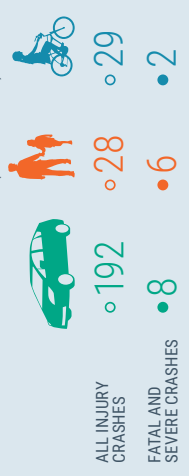

KEY CHARACTERISTICS

- SPEED LIMIT 40**
- Four travel lanes plus raised median/center turn lane.
- Class II bicycle lanes present in some locations.

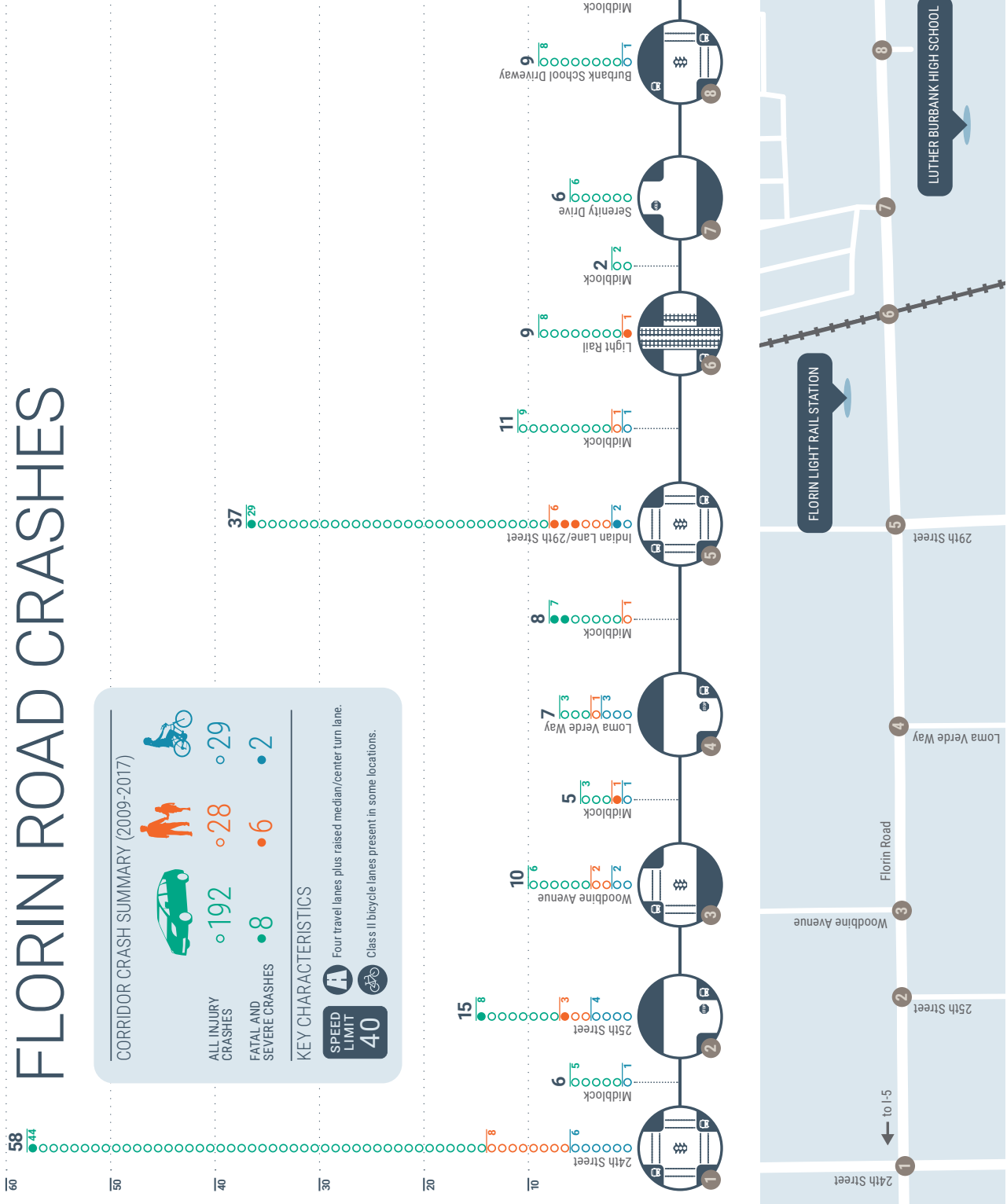

CORRIDOR-WIDE CRASH TYPES

VEHICLE

Unsafe Speed



"Unsafe Speed" was cited as the primary violation in nearly half of all crashes.

1 2 3 4 5 6
7 8 9 10

Proceeding Straight



75% of drivers were proceeding straight or stopped at the time of the crash.

1 2 3 4 5 6
7 8 9 10

Pedestrian Crossing



The majority of people hit while walking were crossing. Half of people were in the crosswalk.

1 2 3 4 5 6
7 8 9 10

Winter Crashes



Over 40% of pedestrian crashes occurred in November, December or January.

1 2 3 4 5 6
7 8 9 10

Rear End



Nearly half of all crashes were rear end.

1 2 3 4 5 6
7 8 9 10

Senior Victims



10 of the 28 people hit while walking were age 60 or older.

1 2 3 4 5 6
7 8 9 10

Right Turns



In nearly 40% of bike crashes, the driver was making a right turn.

1 2 3 4 5 6
7 8 9 10

BICYCLE

Wrong Way Riding



The primary violation cited in over 40% of bicycle crashes was "Wrong Side of Road."

1 2 3 4 5 6
7 8 9 10

Broadside



More than half of bicycle crashes were broadside, also called "T-Bone."

1 2 3 4 5 6
7 8 9 10

1 Numbers that are turned on represent a location where crash type has occurred at least three times.

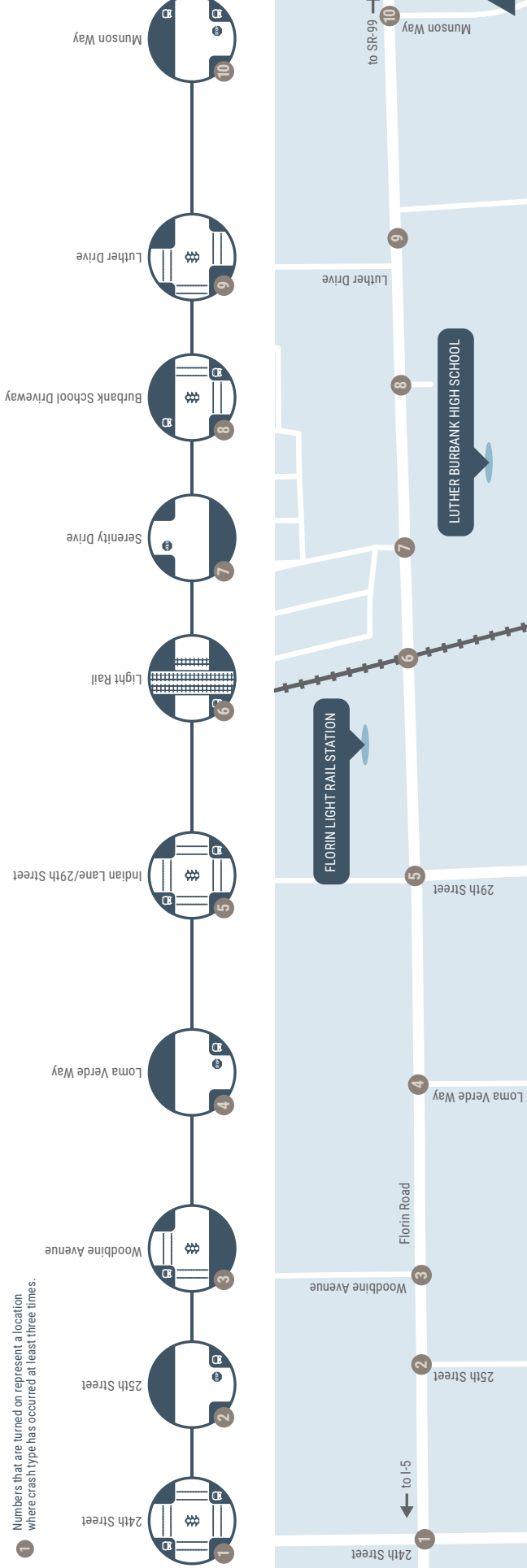

Tell us about your experience traveling along Florin Road:





Comment Card

Please share your thoughts, comments, or questions:

Name _____ Phone _____
Email _____
How did you hear about this event? _____

You can submit your comments to staff today, by mail, by fax (916) 442-1186, or email them directly to Katie Durham at kdurham@aimconsultingco.com

Place
postage
stamp
here

AIM Consulting, Inc.
2523 J Street, Suite 202
Sacramento, CA 95816

Visit www.visionzerosac.org for more information

Public Notification Flyers



The Road Belongs to All of Us

HELP CREATE A SAFER MARYSVILLE!

Join us at the at the Mutual Assistance Network Harvest Festival

Saturday, Oct. 27

11:00 am-2:00 pm

Robertson Community Center

3525 Norwood Avenue

Stop by to tell us about your experience walking and biking on **Marysville Boulevard**, and learn about the City of Sacramento's Top Five Corridors Study.

About the Top Five Corridors Study

In 2017, the City of Sacramento identified the five corridors in Sacramento with the highest numbers of fatal and serious crashes involving pedestrians, bicyclists, and motorists.

Your input will help the City analyze the factors that contribute to these corridors' high crash rates, and identify improvements for each of the corridors.

visionzerosac.org

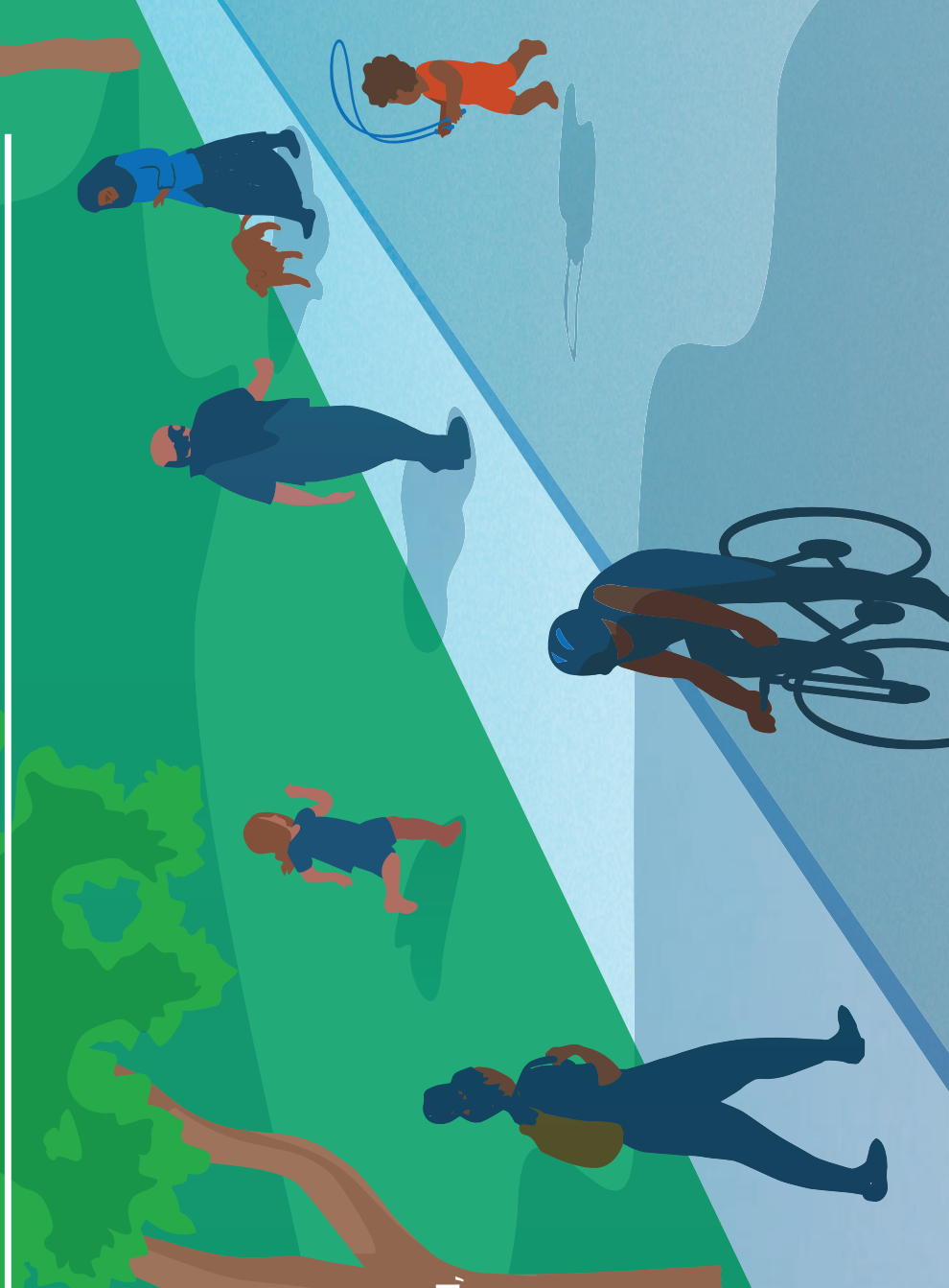



TOP 5 CORRIDORS

Vision
ZERO

The Road Belongs to All of Us

HELP CREATE A SAFER MARYSVILLE

Join us at the at the Hagginwood Community Association Meeting

Wednesday, Dec. 5

6:00 pm–8:00 pm

Hagginwood Community Association Meeting

William J. Kinney Police Facility

3550 Marysville Boulevard

Stop by to tell us about your experience walking and biking on **Marysville**, and learn about the City of Sacramento's Top Five Corridors Study.

About the Top Five Corridors Study

In 2017, the City of Sacramento identified the five corridors in Sacramento with the highest numbers of fatal and serious crashes involving pedestrians, bicyclists, and motorists.

Your input will help the City analyze the factors that contribute to these corridors' high crash rates, and identify improvements for each of the corridors.

visionzerosac.org

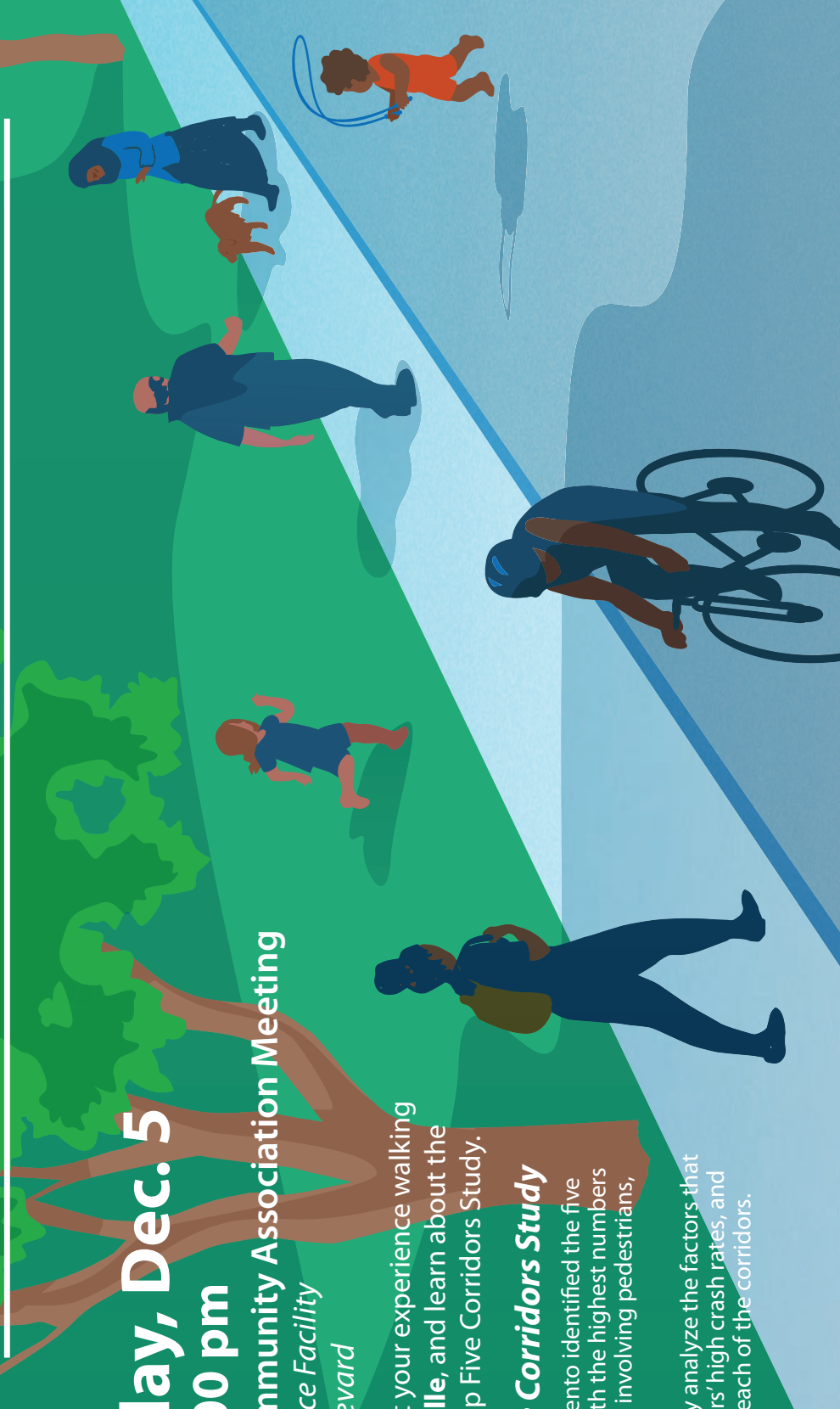



TOP 5 CORRIDORS

Vision
ZERO

The Road Belongs to All of Us

HELP CREATE A SAFER EL CAMINO!

Join us at the at the Old North Sacramento/Dixieanne Community Association Meeting

Saturday, Nov. 10

9:30 am–10:15 am

701 Dixieanne Avenue, Sacramento

Stop by to tell us about your experience walking and biking on **El Camino**, and learn about the City of Sacramento's Top Five Corridors Study.

About the Top Five Corridors Study

In 2017, the City of Sacramento identified the five corridors in Sacramento with the highest numbers of fatal and serious crashes involving pedestrians, bicyclists, and motorists.

Your input will help the City analyze the factors that contribute to these corridors' high crash rates, and identify improvements for each of the corridors.

visionzerosac.org





The Road Belongs to All of Us

HELP CREATE A SAFER EL CAMINO!

Join us at the at Grocery Outlet

Tuesday, Dec. 4

4:00 pm – 6:00 pm

Grocery Outlet

2308 Del Paso Boulevard

Stop by to tell us about your experience walking and biking on **El Camino**, and learn about the City of Sacramento's Top Five Corridors Study.

About the Top Five Corridors Study

In 2017, the City of Sacramento identified the five corridors in Sacramento with the highest numbers of fatal and serious crashes involving pedestrians, bicyclists, and motorists.

Your input will help the City analyze the factors that contribute to these corridors' high crash rates, and identify improvements for each of the corridors.

visionzerosac.org





TOP 5 CORRIDORS

Vision
ZERO

The Road Belongs to All of Us

HELP CREATE A SAFER BROADWAY/STOCKTON

Join us at the at the Oak Park Community Center Family Fall Festival

Thursday, Oct. 25

5:00 pm – 7:00 pm

Oak Park Community Center

3425 Martin Luther King Jr. Boulevard

Stop by to tell us about your experience walking and biking on **Broadway/Stockton**, and learn about the City of Sacramento's Top Five Corridors Study.

About the Top Five Corridors Study

In 2017, the City of Sacramento identified the five corridors in Sacramento with the highest numbers of fatal and serious crashes involving pedestrians, bicyclists, and motorists.

Your input will help the City analyze the factors that contribute to these corridors' high crash rates, and identify improvements for each of the corridors.

visionzerosac.org





TOP 5 CORRIDORS

Vision
ZERO

The Road Belongs to All of Us

HELP CREATE A SAFER BROADWAY/STOCKTON

Join us at the at the Transit Stop at Broadway/Stockton

Wednesday, Nov. 7

12:00 pm – 2:00 pm

Transit Stop at Broadway/Stockton

Broadway/Stockton WB, outside Food Source

Stop by to tell us about your experience walking and biking on **Broadway/Stockton**, and learn about the City of Sacramento's Top Five Corridors Study.

About the Top Five Corridors Study

In 2017, the City of Sacramento identified the five corridors in Sacramento with the highest numbers of fatal and serious crashes involving pedestrians, bicyclists, and motorists.

Your input will help the City analyze the factors that contribute to these corridors' high crash rates, and identify improvements for each of the corridors.

visionzerosac.org



Help create a **safer** South Stockton Boulevard!

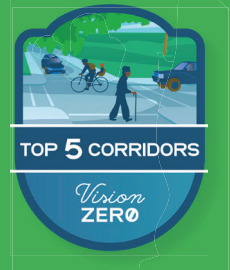

Join us at a
Community Open House

Monday, November 5

5:00 – 7:00 p.m.

Peter Burnett Elementary School

6032 36th Avenue, Sacramento, CA

RSVP : [visionzerotop5southstockton.eventbrite.com](https://www.eventbrite.com/e/visionzerotop5southstockton)

Stop by anytime between 5:00 and 7:00 p.m. to tell us your experience walking and biking on **South Stockton Boulevard** and learn about the City of Sacramento's Vision Zero Top Five Corridors Study.

About the Study

In 2017, the City of Sacramento identified five corridors in the City of Sacramento with the highest numbers of fatal and serious crashes involving pedestrians, bicyclists, and motorists.

Your input will help the City analyze the factors that contribute to these high crash rates and identify improvements for each of the corridors.

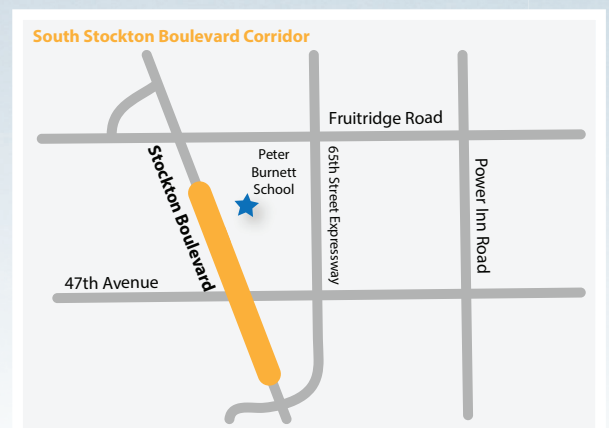

More information about the project is available at www.VisionZeroSac.org

City of
SACRAMENTO



我們講中文 • Hablamos español • Мы говорим по-русски • ພວກເຮົາເວົ້າພາສາລາວ • Peb hais lus Hmoob • Chúng tôi nói tiếng Việt

Help create a **safer** Florin Road

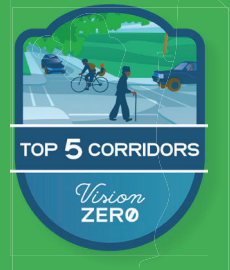

Join us at a

Community Open House

Thursday, November 15

5:00–7:00 p.m.

Luther Burbank High School

3500 Florin Road, Sacramento, CA

RSVP : visionzerotop5florin.eventbrite.com

Stop by anytime between 5:00 and 7:00 p.m. to tell us your experience walking and biking on **Florin Road** and learn about the City of Sacramento's Vision Zero Top Five Corridors Study.

About the Study

In 2017, the City of Sacramento identified five corridors in the City of Sacramento with the highest numbers of fatal and serious crashes involving pedestrians, bicyclists, and motorists.

Your input will help the City analyze the factors that contribute to these high crash rates and identify improvements for each of the corridors.

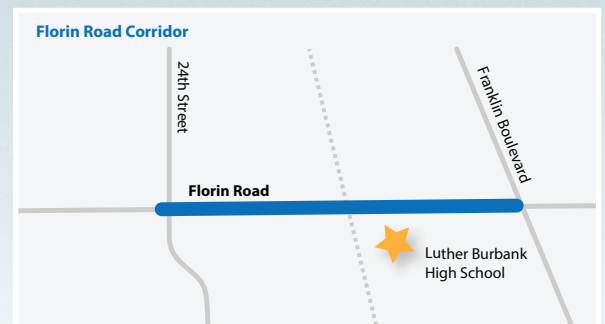

More information about the project is available at www.VisionZeroSac.org

City of
SACRAMENTO



我們講中文 • Hablamos español • Мы говорим по-русски • ພວກເຮົາເວົ້າພາສາລາວ • Peb hais lus Hmoob • Chúng tôi nói tiếng Việt

Appendix B – Data and Technical Calculations

Peak Hour Traffic Volumes and Lane Configurations

Existing Conditions

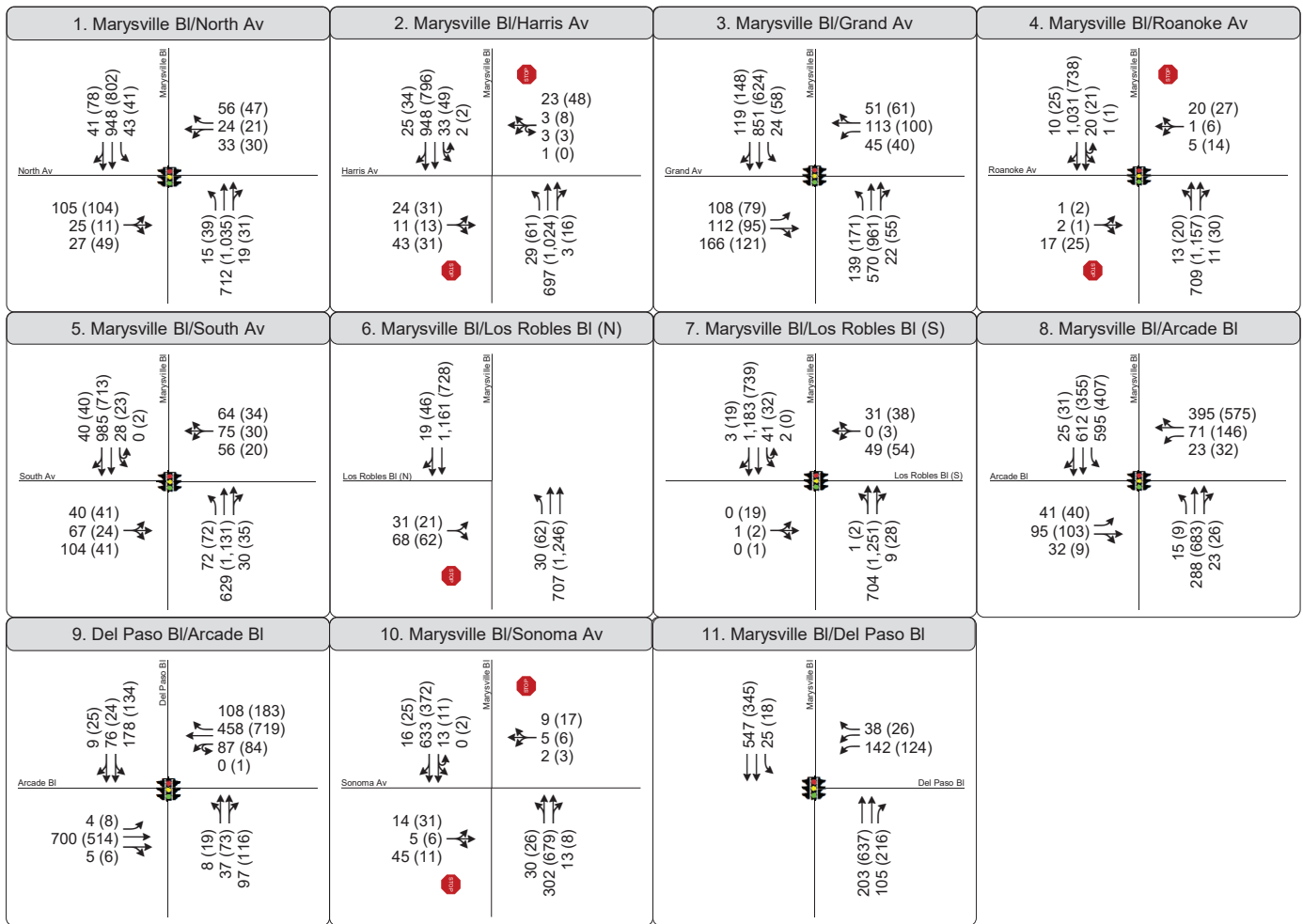

Counts taken May 30, 2018
 AM Peak Hour: 7:15-8:15 AM; 0.93 PHF; 4% HV
 PM Peak Hour: 5:00-6:00 PM; 0.96 PHF; 2% HV

Figure
 Marysville Boulevard
 Peak Hour Traffic Volumes and Lane Configurations
 Existing Conditions



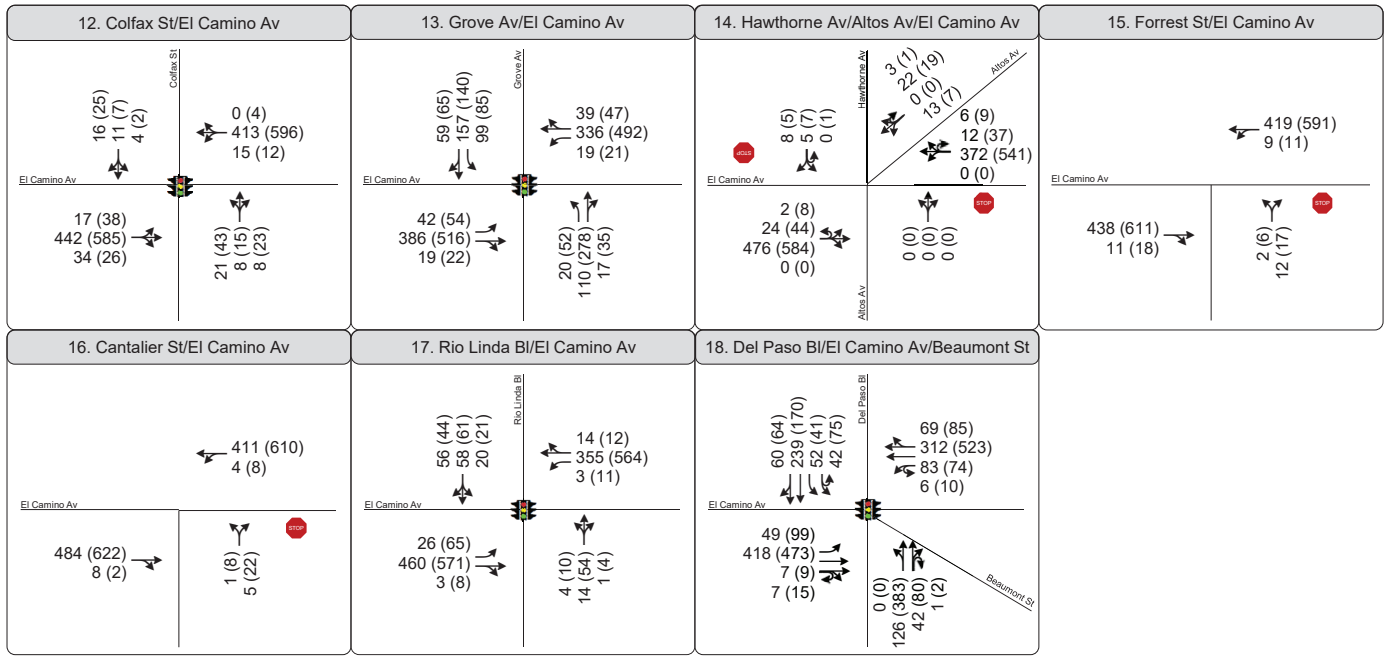

Counts taken May 24, 2018
 AM Peak Hour: 7:30-8:30 AM; 0.91 PHF; 2% HV
 PM Peak Hour: 5:00-6:00 PM; 0.97 PHF; 1% HV

Figure
 El Camino Avenue
 Peak Hour Traffic Volumes and Lane Configurations
 Existing Conditions



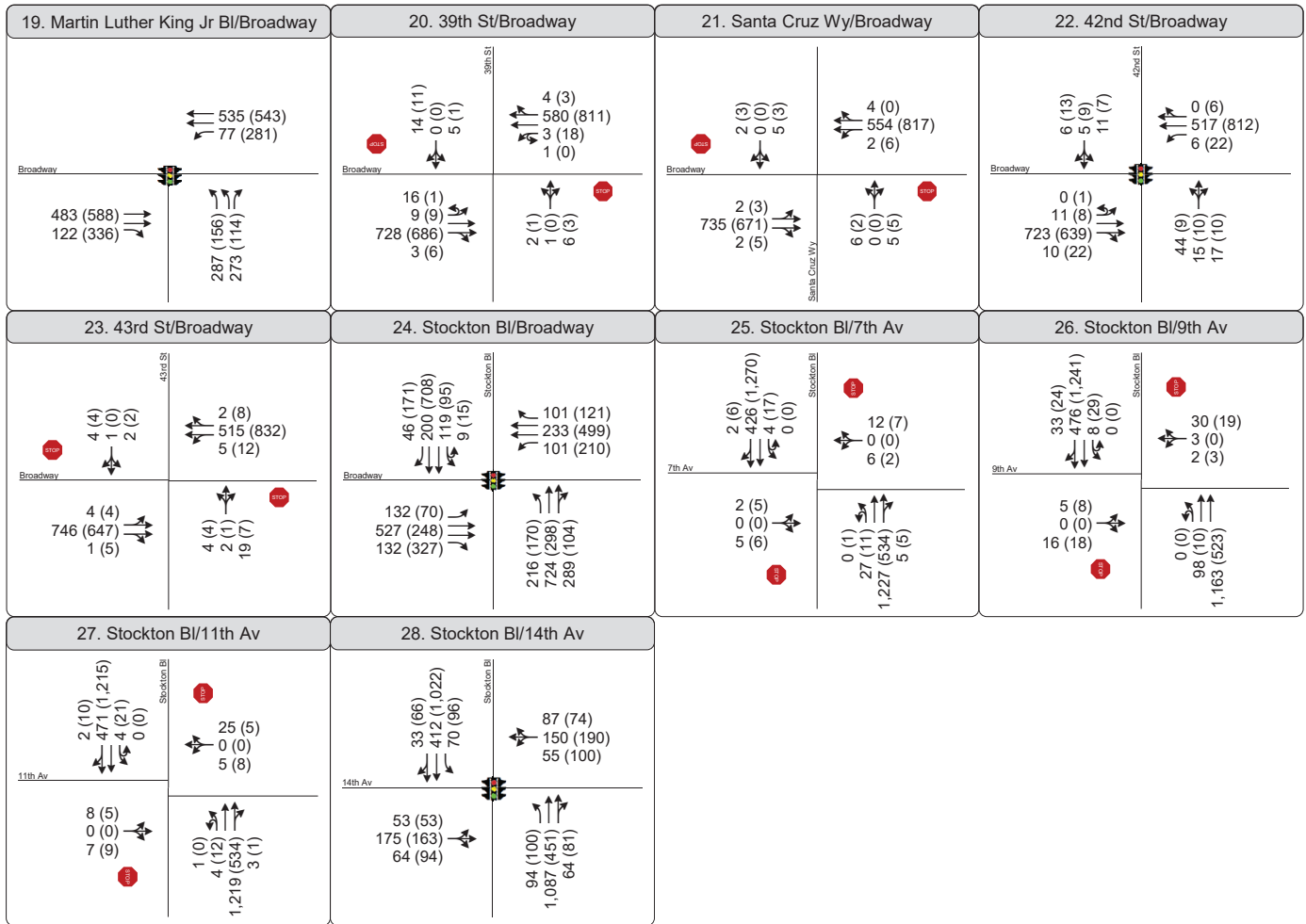

Counts taken May 31, 2018
 AM Peak Hour: 7:15-8:15 AM; 0.87 PHF; 2% HV
 PM Peak Hour: 4:30-5:30 PM; 0.94 PHF; 1% HV

Figure
 Broadway/Stockton Boulevard (North)
 Peak Hour Traffic Volumes and Lane Configurations
 Existing Conditions



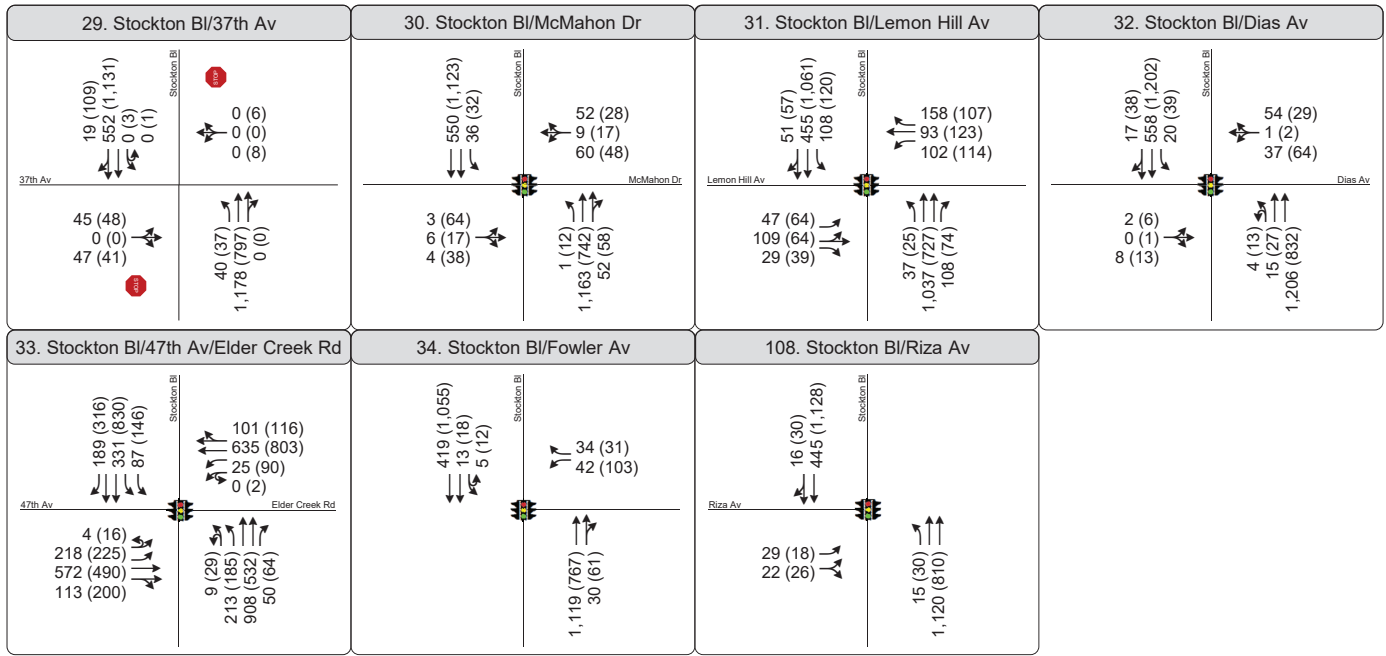

Counts taken May 31, 2018
 AM Peak Hour: 7:15-8:15 AM; 0.89 PHF; 2% HV
 PM Peak Hour: 4:15-5:15 PM; 0.95 PHF; 1% HV

Figure
 Stockton Boulevard (South)
 Peak Hour Traffic Volumes and Lane Configurations
 Existing Conditions



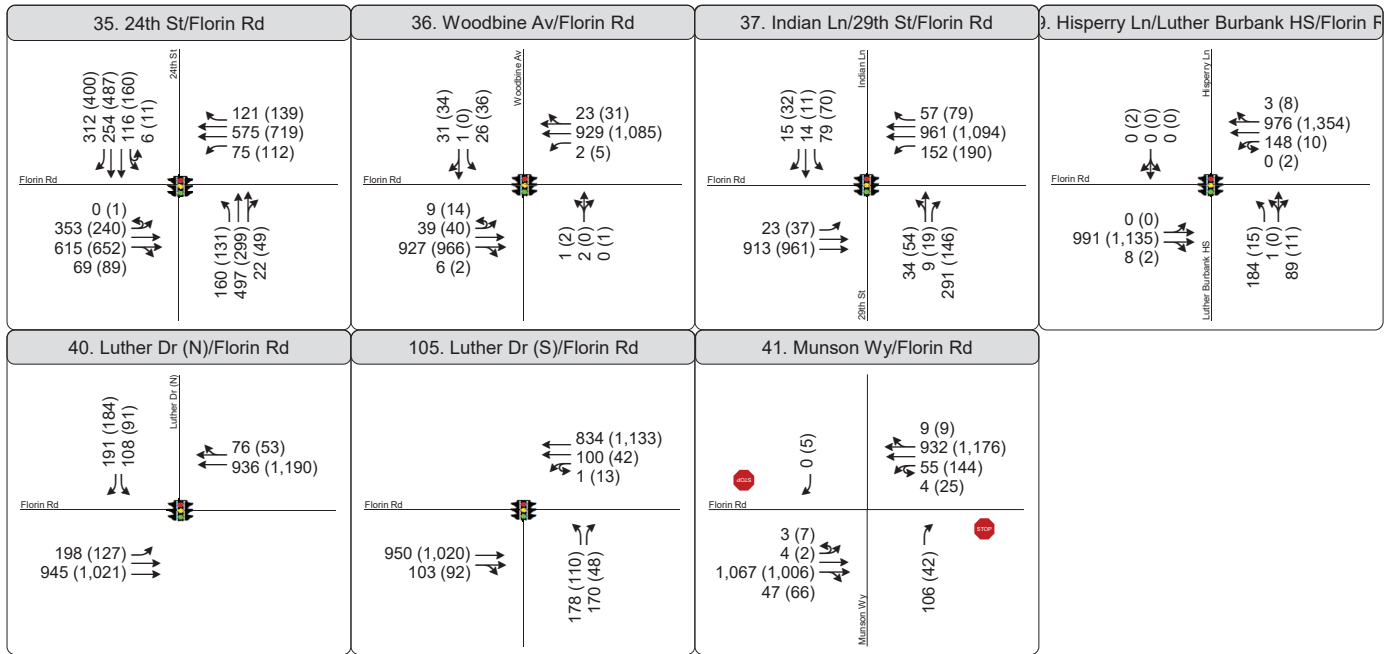

Counts taken May 31, 2018
 AM Peak Hour: 7:30-8:30 AM; 0.91 PHF; 3% HV
 PM Peak Hour: 4:30-5:30 PM; 0.95 PHF; 2% HV

Figure
 Florin Road
 Peak Hour Traffic Volumes and Lane Configurations
 Existing Conditions



Level of Service Results

Existing Conditions

SimTraffic Post-Processor
Average Results from 10 Runs
Volume and Delay by Movement

Vision Zero Top 5 Corridors - Marysville Bl
Existing Conditions
AM Peak Hour

Intersection 1 Marysville Bl/North Av Signal

Direction	Movement	Demand Volume (vph)	Served Volume (vph)		Total Delay (sec/veh)		
			Average	Percent	Average	Std. Dev.	LOS
NB	Left Turn	15	14	94.2%	27.3	8.1	C
	Through	712	676	94.9%	8.8	2.0	A
	Right Turn	19	17	92.0%	5.7	4.3	A
	Subtotal	746	708	94.8%	9.1	2.0	A
SB	Left Turn	43	52	120.3%	27.1	8.4	C
	Through	948	943	99.5%	8.3	1.6	A
	Right Turn	41	43	104.3%	5.1	2.7	A
	Subtotal	1,032	1,038	100.6%	9.1	1.9	A
EB	Left Turn	105	108	102.7%	16.5	2.6	B
	Through	25	21	83.3%	17.2	6.6	B
	Right Turn	27	29	107.5%	10.2	3.5	B
	Subtotal	157	158	100.5%	15.5	2.6	B
WB	Left Turn	33	36	110.5%	17.4	4.6	B
	Through	24	28	116.3%	18.7	5.6	B
	Right Turn	56	56	100.3%	5.9	1.6	A
	Subtotal	113	121	106.7%	12.2	2.3	B
Total		2,048	2,024	98.8%	9.7	1.4	A

Intersection 2 Marysville Bl/Harris Av Side-street Stop

Direction	Movement	Demand Volume (vph)	Served Volume (vph)		Total Delay (sec/veh)		
			Average	Percent	Average	Std. Dev.	LOS
NB	Left Turn	29	28	97.5%	9.4	2.8	A
	Through	697	663	95.1%	1.9	0.3	A
	Right Turn	3	4	124.0%	1.1	1.3	A
	Subtotal	729	695	95.3%	2.2	0.3	A
SB	Left Turn	35	35	99.9%	7.4	3.5	A
	Through	948	947	99.9%	2.8	0.3	A
	Right Turn	25	29	114.6%	2.0	0.7	A
	Subtotal	1,008	1,011	100.3%	2.9	0.4	A
EB	Left Turn	24	24	99.2%	19.6	8.6	C
	Through	11	12	104.8%	23.4	14.7	C
	Right Turn	43	49	113.3%	13.1	4.5	B
	Subtotal	78	84	107.8%	16.5	5.6	C
WB	Left Turn	4	3	83.7%	12.0	14.9	B
	Through	3	5	161.2%	11.3	12.3	B
	Right Turn	23	21	90.6%	6.7	2.0	A
	Subtotal	30	29	96.7%	10.0	4.0	B
Total		1,845	1,819	98.6%	3.4	0.5	A

SimTraffic Post-Processor
Average Results from 10 Runs
Volume and Delay by Movement

Vision Zero Top 5 Corridors - Marysville Bl
Existing Conditions
AM Peak Hour

Intersection 3 Marysville Bl/Grand Av Signal

Direction	Movement	Demand Volume (vph)	Served Volume (vph)		Total Delay (sec/veh)		
			Average	Percent	Average	Std. Dev.	LOS
NB	Left Turn	139	142	102.5%	37.3	6.2	D
	Through	570	552	96.9%	11.3	2.9	B
	Right Turn	22	16	74.4%	9.5	7.3	A
	Subtotal	731	711	97.2%	16.5	2.5	B
SB	Left Turn	24	21	86.8%	54.9	15.3	D
	Through	851	872	102.4%	22.3	2.2	C
	Right Turn	119	108	91.0%	18.6	5.5	B
	Subtotal	994	1,001	100.7%	22.5	2.1	C
EB	Left Turn	108	103	95.8%	29.8	5.8	C
	Through	112	108	96.7%	25.1	4.4	C
	Right Turn	166	167	100.6%	16.0	3.2	B
	Subtotal	386	379	98.1%	22.5	3.2	C
WB	Left Turn	45	47	104.2%	26.4	8.0	C
	Through	113	104	91.8%	22.8	4.5	C
	Right Turn	51	47	91.9%	13.5	4.9	B
	Subtotal	209	198	94.5%	21.6	2.5	C
Total		2,320	2,288	98.6%	20.5	1.8	C

Intersection 4 Marysville Bl/Roanoke Av Side-street Stop

Direction	Movement	Demand Volume (vph)	Served Volume (vph)		Total Delay (sec/veh)		
			Average	Percent	Average	Std. Dev.	LOS
NB	Left Turn	13	12	91.6%	12.8	9.2	B
	Through	709	679	95.8%	4.5	2.7	A
	Right Turn	11	13	115.0%	5.2	3.7	A
	Subtotal	733	704	96.0%	4.7	2.8	A
SB	Left Turn	21	23	108.1%	10.4	3.7	B
	Through	1,031	1,042	101.1%	6.6	2.4	A
	Right Turn	10	13	126.5%	6.2	2.4	A
	Subtotal	1,062	1,078	101.5%	6.7	2.4	A
EB	Left Turn	1	1	111.6%	14.4	40.5	B
	Through	2	1	55.8%	4.2	9.4	A
	Right Turn	17	17	100.7%	9.1	4.8	A
	Subtotal	20	19	96.7%	12.2	10.3	B
WB	Left Turn	5	5	96.7%	15.8	13.5	C
	Through	1	1	74.4%	4.4	11.6	A
	Right Turn	20	22	111.6%	7.7	3.6	A
	Subtotal	26	28	107.3%	9.7	3.4	A
Total		1,841	1,829	99.3%	6.0	2.4	A

SimTraffic Post-Processor
Average Results from 10 Runs
Volume and Delay by Movement

Vision Zero Top 5 Corridors - Marysville BI
Existing Conditions
AM Peak Hour

Intersection 5 Marysville BI/South Av Signal

Direction	Movement	Demand Volume (vph)	Served Volume (vph)		Total Delay (sec/veh)		
			Average	Percent	Average	Std. Dev.	LOS
NB	Left Turn	72	64	88.9%	32.1	4.7	C
	Through	629	595	94.6%	8.6	1.6	A
	Right Turn	30	33	110.4%	6.8	1.7	A
	Subtotal	731	692	94.7%	10.7	1.6	B
SB	Left Turn	28	23	81.0%	40.7	9.3	D
	Through	985	985	100.0%	14.0	2.7	B
	Right Turn	40	44	110.7%	11.4	3.1	B
	Subtotal	1,053	1,052	99.9%	14.5	2.7	B
EB	Left Turn	40	39	97.7%	24.5	8.5	C
	Through	67	60	88.8%	27.8	3.6	C
	Right Turn	104	99	95.5%	15.9	3.8	B
	Subtotal	211	198	93.8%	21.6	3.9	C
WB	Left Turn	56	47	84.4%	20.2	6.8	C
	Through	75	79	105.6%	24.4	6.4	C
	Right Turn	64	67	105.2%	14.4	4.0	B
	Subtotal	195	194	99.4%	20.0	4.6	B
Total		2,190	2,136	97.5%	14.4	1.6	B

Intersection 6 Marysville BI/Los Robles BI (N) Side-street Stop

Direction	Movement	Demand Volume (vph)	Served Volume (vph)		Total Delay (sec/veh)		
			Average	Percent	Average	Std. Dev.	LOS
NB	Left Turn	30	28	91.8%	10.8	4.0	B
	Through	707	678	95.9%	1.2	0.3	A
	Right Turn						
	Subtotal	737	705	95.7%	1.6	0.4	A
SB	Left Turn						
	Through	1,161	1,141	98.2%	0.4	0.1	A
	Right Turn	19	21	109.6%	0.1	0.1	A
	Subtotal	1,180	1,161	98.4%	0.4	0.1	A
EB	Left Turn	31	32	104.4%	21.6	6.3	C
	Through						
	Right Turn	68	80	117.6%	12.9	3.7	B
	Subtotal	99	112	113.5%	15.6	3.1	C
WB	Left Turn						
	Through						
	Right Turn						
	Subtotal						
Total		2,016	1,979	98.2%	1.7	0.3	A

SimTraffic Post-Processor
Average Results from 10 Runs
Volume and Delay by Movement

Vision Zero Top 5 Corridors - Marysville BI
Existing Conditions
AM Peak Hour

Intersection 7 Marysville BI/Los Robles BI (S) Signal

Direction	Movement	Demand Volume (vph)	Served Volume (vph)		Total Delay (sec/veh)		
			Average	Percent	Average	Std. Dev.	LOS
NB	Left Turn	1	0	37.2%	4.5	14.2	A
	Through	704	677	96.2%	3.6	0.8	A
	Right Turn	9	10	111.6%	1.7	1.5	A
	Subtotal	714	687	96.3%	3.6	0.8	A
SB	Left Turn	43	38	89.1%	11.9	3.9	B
	Through	1,183	1,175	99.3%	4.9	1.0	A
	Right Turn	3	4	124.0%	0.7	1.2	A
	Subtotal	1,229	1,217	99.0%	5.1	1.1	A
EB	Left Turn						
	Through	1	1	148.8%	4.0	8.1	A
	Right Turn						
	Subtotal	1	1	148.8%	4.0	8.1	A
WB	Left Turn	49	54	109.3%	13.7	3.7	B
	Through						
	Right Turn	31	32	104.4%	6.8	3.5	A
	Subtotal	80	86	107.4%	11.4	3.3	B
Total		2,024	1,992	98.4%	4.8	0.8	A

Intersection 8 Marysville BI/Arcade BI Signal

Direction	Movement	Demand Volume (vph)	Served Volume (vph)		Total Delay (sec/veh)		
			Average	Percent	Average	Std. Dev.	LOS
NB	Left Turn	15	11	71.9%	39.3	22.4	D
	Through	288	273	94.8%	37.0	3.8	D
	Right Turn	23	21	92.2%	21.4	5.5	C
	Subtotal	326	305	93.6%	36.4	3.7	D
SB	Left Turn	595	563	94.6%	43.4	10.6	D
	Through	612	610	99.7%	18.2	4.3	B
	Right Turn	25	27	108.6%	14.8	4.4	B
	Subtotal	1,232	1,200	97.4%	30.0	7.1	C
EB	Left Turn	41	38	93.5%	27.8	6.3	C
	Through	95	93	97.5%	22.1	7.1	C
	Right Turn	32	29	89.5%	12.5	8.5	B
	Subtotal	168	160	95.0%	21.8	5.7	C
WB	Left Turn	23	24	103.5%	40.7	10.8	D
	Through	71	72	101.6%	43.3	16.8	D
	Right Turn	395	385	97.5%	30.0	14.7	C
	Subtotal	489	481	98.4%	32.6	14.5	C
Total		2,215	2,146	96.9%	30.9	5.5	C

SimTraffic Post-Processor
Average Results from 10 Runs
Volume and Delay by Movement

Vision Zero Top 5 Corridors - Marysville BI
Existing Conditions
AM Peak Hour

Intersection 9 Del Paso BI/Arcade BI Signal

Direction	Movement	Demand Volume (vph)	Served Volume (vph)		Total Delay (sec/veh)		
			Average	Percent	Average	Std. Dev.	LOS
NB	Left Turn	8	7	93.0%	24.3	17.4	C
	Through	37	38	103.6%	27.7	5.2	C
	Right Turn	97	92	94.3%	7.0	2.4	A
	Subtotal	142	137	96.7%	14.2	3.2	B
SB	Left Turn	178	156	87.6%	29.3	3.8	C
	Through	76	78	102.3%	27.7	5.5	C
	Right Turn	9	12	128.1%	8.1	7.1	A
	Subtotal	263	245	93.2%	27.8	2.9	C
EB	Left Turn	4	2	55.8%	24.4	28.7	C
	Through	700	665	95.0%	16.8	2.3	B
	Right Turn	5	3	67.0%	10.5	13.4	B
	Subtotal	709	670	94.5%	16.9	2.2	B
WB	Left Turn	87	83	95.8%	29.9	4.4	C
	Through	458	457	99.8%	12.1	2.2	B
	Right Turn	108	94	86.8%	3.1	0.3	A
	Subtotal	653	634	97.1%	13.2	1.7	B
Total		1,767	1,687	95.5%	16.8	1.2	B

Intersection 10 Marysville BI/Sonoma Av Side-street Stop

Direction	Movement	Demand Volume (vph)	Served Volume (vph)		Total Delay (sec/veh)		
			Average	Percent	Average	Std. Dev.	LOS
NB	Left Turn	30	32	106.6%	6.2	2.4	A
	Through	302	286	94.6%	1.1	0.3	A
	Right Turn	13	13	100.2%	0.6	0.6	A
	Subtotal	345	331	95.9%	1.6	0.4	A
SB	Left Turn	13	12	94.4%	2.9	1.8	A
	Through	633	631	99.6%	0.9	0.1	A
	Right Turn	16	12	72.1%	0.6	0.9	A
	Subtotal	662	654	98.8%	1.0	0.2	A
EB	Left Turn	14	13	90.3%	15.1	6.4	C
	Through	5	3	59.5%	9.4	14.7	A
	Right Turn	45	48	106.6%	8.9	2.5	A
	Subtotal	64	64	99.4%	10.8	3.3	B
WB	Left Turn	2	2	93.0%	5.4	11.0	A
	Through	5	4	81.8%	9.5	10.7	A
	Right Turn	9	8	90.9%	4.8	2.8	A
	Subtotal	16	14	88.4%	9.5	4.3	A
Total		1,087	1,063	97.8%	1.9	0.3	A

SimTraffic Post-Processor
Average Results from 10 Runs
Volume and Delay by Movement

Vision Zero Top 5 Corridors - Marysville BI
Existing Conditions
AM Peak Hour

Intersection 11 Marysville BI/Del Paso BI Signal

Direction	Movement	Demand Volume (vph)	Served Volume (vph)		Total Delay (sec/veh)		
			Average	Percent	Average	Std. Dev.	LOS
NB	Left Turn						
	Through	203	196	96.6%	4.9	1.0	A
	Right Turn	105	94	89.6%	1.5	0.2	A
	Subtotal	308	290	94.2%	3.8	0.8	A
SB	Left Turn	25	24	96.7%	16.9	5.6	B
	Through	547	525	95.9%	5.4	1.1	A
	Right Turn						
	Subtotal	572	549	95.9%	5.9	1.1	A
EB	Left Turn						
	Through						
	Right Turn						
	Subtotal						
WB	Left Turn	142	144	101.1%	9.7	1.6	A
	Through						
	Right Turn	38	38	98.9%	3.8	0.3	A
	Subtotal	180	181	100.6%	8.5	1.3	A
Total		1,060	1,020	96.2%	5.8	0.7	A

SimTraffic Post-Processor
Average Results from 10 Runs
Volume and Delay by Movement

Vision Zero Top 5 Corridors - El Camino Av
Existing Conditions
AM Peak Hour

Intersection 12 Colfax St/El Camino Av Signal

Direction	Movement	Demand Volume (vph)	Served Volume (vph)		Total Delay (sec/veh)		
			Average	Percent	Average	Std. Dev.	LOS
NB	Left Turn	21	23	109.2%	7.0	3.7	A
	Through	8	9	118.3%	3.8	2.9	A
	Right Turn	8	8	95.6%	3.1	2.8	A
	Subtotal	37	40	108.2%	5.8	2.5	A
SB	Left Turn	4	3	63.7%	7.6	16.9	A
	Through	11	12	105.9%	8.6	7.1	A
	Right Turn	16	15	93.3%	4.6	3.7	A
	Subtotal	31	29	93.9%	6.3	4.6	A
EB	Left Turn	17	17	100.6%	5.3	3.3	A
	Through	442	450	101.7%	3.5	0.7	A
	Right Turn	34	25	74.9%	2.2	0.8	A
	Subtotal	493	492	99.8%	3.5	0.7	A
WB	Left Turn	15	10	65.5%	6.5	3.4	A
	Through	413	383	92.7%	3.5	0.7	A
	Right Turn						
	Subtotal	428	393	91.8%	3.5	0.8	A
Total		989	954	96.5%	3.7	0.5	A

Intersection 13 Grove Av/El Camino Av Signal

Direction	Movement	Demand Volume (vph)	Served Volume (vph)		Total Delay (sec/veh)		
			Average	Percent	Average	Std. Dev.	LOS
NB	Left Turn	20	21	107.4%	27.6	6.4	C
	Through	110	108	98.3%	27.5	6.0	C
	Right Turn	17	16	94.2%	17.9	10.6	B
	Subtotal	147	146	99.0%	26.5	5.8	C
SB	Left Turn	99	99	100.4%	24.5	6.3	C
	Through	157	157	99.7%	25.1	5.9	C
	Right Turn	59	50	83.9%	17.2	4.7	B
	Subtotal	315	305	97.0%	23.6	4.5	C
EB	Left Turn	42	45	107.5%	44.1	16.8	D
	Through	386	388	100.6%	19.3	5.5	B
	Right Turn	19	20	107.3%	22.9	22.7	C
	Subtotal	447	454	101.5%	21.8	7.1	C
WB	Left Turn	19	17	92.0%	53.0	14.9	D
	Through	344	329	95.7%	25.8	6.3	C
	Right Turn	39	40	101.7%	21.2	7.3	C
	Subtotal	402	386	96.1%	26.5	6.4	C
Total		1,311	1,291	98.5%	24.2	5.2	C

SimTraffic Post-Processor
Average Results from 10 Runs
Volume and Delay by Movement

Vision Zero Top 5 Corridors - El Camino Av
Existing Conditions
AM Peak Hour

Intersection 14 Hawthorne Av-Altos Av/El Camino Av Side-street Stop

Direction	Movement	Demand Volume (vph)	Served Volume (vph)		Total Delay (sec/veh)		
			Average	Percent	Average	Std. Dev.	LOS
EB	Left Turn	26	28	106.4%	16.7	6.0	C
	Through	476	471	99.0%	6.1	1.5	A
	Right Turn						
	Subtotal	502	499	99.4%	6.6	1.8	A
SB	Left Turn	13	13	100.8%	39.9	28.6	E
	Through	22	19	84.4%	13.9	11.2	B
	Right Turn	3	2	72.8%	15.0	10.9	B
	Subtotal	38	34	89.1%	22.0	10.2	C
SE	Left Turn	5	4	80.1%	20.0	21.8	C
	Through						
	Right Turn	8	6	72.8%	10.1	8.3	B
	Subtotal	13	10	75.6%	15.9	11.6	C
WB	Left Turn						
	Through	372	362	97.3%	5.3	2.8	A
	Right Turn	18	16	89.0%	4.6	2.4	A
	Subtotal	390	378	96.9%	5.3	2.8	A
Total		943	921	97.6%	6.8	1.8	A

Intersection 15 Forrest St/El Camino Av Side-street Stop

Direction	Movement	Demand Volume (vph)	Served Volume (vph)		Total Delay (sec/veh)		
			Average	Percent	Average	Std. Dev.	LOS
NB	Left Turn	2	1	54.6%	3.6	7.1	A
	Through						
	Right Turn	12	13	109.2%	4.1	2.0	A
	Subtotal	14	14	101.4%	4.5	2.3	A
SB	Left Turn						
	Through						
	Right Turn						
	Subtotal						
EB	Left Turn						
	Through	438	429	98.0%	0.9	0.2	A
	Right Turn	11	11	102.6%	0.6	0.5	A
	Subtotal	449	440	98.1%	0.9	0.2	A
WB	Left Turn	9	7	80.9%	4.9	3.9	A
	Through	419	409	97.6%	1.7	0.4	A
	Right Turn						
	Subtotal	428	416	97.2%	1.8	0.4	A
Total		891	871	97.7%	1.4	0.3	A

SimTraffic Post-Processor
Average Results from 10 Runs
Volume and Delay by Movement

Vision Zero Top 5 Corridors - El Camino Av
Existing Conditions
AM Peak Hour

Intersection 16 Cantalier St/El Camino Av Side-street Stop

Direction	Movement	Demand Volume (vph)	Served Volume (vph)		Total Delay (sec/veh)		
			Average	Percent	Average	Std. Dev.	LOS
NB	Left Turn	1	0	36.4%	0.4	1.1	A
	Through						
	Right Turn	5	7	145.6%	4.1	3.2	A
	Subtotal	6	8	127.4%	4.1	3.2	A
SB	Left Turn						
	Through						
	Right Turn						
	Subtotal						
EB	Left Turn						
	Through	484	471	97.4%	0.7	0.3	A
	Right Turn	8	8	100.1%	0.2	0.3	A
	Subtotal	492	479	97.4%	0.7	0.2	A
WB	Left Turn	4	5	136.5%	3.2	3.6	A
	Through	411	405	98.7%	1.4	0.3	A
	Right Turn						
	Subtotal	415	411	99.0%	1.4	0.3	A
Total		913	898	98.4%	1.0	0.2	A

Intersection 17 Rio Linda Bl/El Camino Av Signal

Direction	Movement	Demand Volume (vph)	Served Volume (vph)		Total Delay (sec/veh)		
			Average	Percent	Average	Std. Dev.	LOS
NB	Left Turn	4	3	63.7%	10.0	15.3	A
	Through	14	15	104.0%	25.0	10.9	C
	Right Turn	1	0	36.4%	2.8	8.9	A
	Subtotal	19	17	92.0%	25.0	10.8	C
SB	Left Turn	20	23	116.5%	20.6	8.4	C
	Through	58	54	93.5%	24.2	5.1	C
	Right Turn	56	55	98.8%	12.1	3.2	B
	Subtotal	134	133	99.1%	18.3	3.1	B
EB	Left Turn	26	25	96.6%	9.0	4.2	A
	Through	460	451	98.0%	3.6	0.7	A
	Right Turn	3	2	60.7%	0.8	1.7	A
	Subtotal	489	478	97.7%	3.9	0.7	A
WB	Left Turn	3	1	48.5%	4.4	5.5	A
	Through	355	354	99.7%	5.5	1.1	A
	Right Turn	14	13	96.2%	5.5	4.2	A
	Subtotal	372	369	99.1%	5.6	1.1	A
Total		1,014	997	98.3%	6.8	0.8	A

SimTraffic Post-Processor
Average Results from 10 Runs
Volume and Delay by Movement

Vision Zero Top 5 Corridors - El Camino Av
Existing Conditions
AM Peak Hour

Intersection 18

Del Paso Bl-Beaumont St/El Camino Av

Signal

Direction	Movement	Demand Volume (vph)	Served Volume (vph)		Total Delay (sec/veh)		
			Average	Percent	Average	Std. Dev.	LOS
NB	Left Turn						
	Through	126	123	97.6%	30.7	4.6	C
	Right Turn	43	51	117.7%	30.3	5.8	C
	Subtotal	169	174	102.7%	30.5	3.8	C
SB	Left Turn	94	94	100.3%	39.0	6.0	D
	Through	239	227	95.0%	27.1	3.7	C
	Right Turn	60	61	101.9%	6.3	2.6	A
	Subtotal	393	383	97.3%	26.7	3.8	C
EB	Left Turn	49	47	96.6%	36.0	8.4	D
	Through	425	415	97.6%	24.7	4.7	C
	Right Turn	7	9	124.8%	11.1	9.1	B
	Subtotal	481	471	97.8%	25.5	3.8	C
WB	Left Turn	89	77	86.3%	38.9	9.4	D
	Through	312	310	99.4%	23.8	3.8	C
	Right Turn	69	77	111.3%	2.8	0.4	A
	Subtotal	470	464	98.7%	22.9	4.0	C
Total		1,513	1,491	98.5%	25.5	2.4	C

Intersection 19 **Martin Luther King Jr BI/Broadway** **Signal**

Direction	Movement	Demand Volume (vph)	Served Volume (vph)		Total Delay (sec/veh)		
			Average	Percent	Average	Std. Dev.	LOS
NB	Left Turn	287	286	99.7%	62.2	143.7	E
	Through						
	Right Turn	273	268	98.1%	42.0	109.9	D
	Subtotal	560	554	98.9%	52.3	126.7	D
SB	Left Turn						
	Through						
	Right Turn						
	Subtotal						
EB	Left Turn						
	Through	483	486	100.6%	9.2	3.3	A
	Right Turn	122	118	97.1%	5.0	1.5	A
	Subtotal	605	604	99.9%	8.4	2.8	A
WB	Left Turn	77	58	75.2%	74.0	145.6	E
	Through	535	531	99.2%	10.2	5.3	B
	Right Turn						
	Subtotal	612	588	96.2%	12.7	6.6	B
Total		1,777	1,747	98.3%	13.7	9.5	B

Intersection 20 **39th St/Broadway** **Side-street Stop**

Direction	Movement	Demand Volume (vph)	Served Volume (vph)		Total Delay (sec/veh)		
			Average	Percent	Average	Std. Dev.	LOS
NB	Left Turn	2	1	56.4%	1.2	2.0	A
	Through	1	1	112.8%	20.2	54.1	C
	Right Turn	6	6	106.5%	5.2	3.4	A
	Subtotal	9	9	96.1%	14.4	27.2	B
SB	Left Turn	5	5	97.8%	13.9	19.6	B
	Through						
	Right Turn	14	12	85.9%	10.5	19.7	B
	Subtotal	19	17	89.1%	7.7	5.5	A
EB	Left Turn	25	24	94.8%	7.3	12.7	A
	Through	728	725	99.6%	1.2	0.1	A
	Right Turn	3	1	37.6%	1.2	0.1	A
	Subtotal	756	750	99.2%	1.4	0.4	A
WB	Left Turn	4	2	56.4%	6.2	13.2	A
	Through	580	566	97.5%	2.6	5.8	A
	Right Turn	4	4	94.0%	0.6	0.9	A
	Subtotal	588	572	97.2%	2.6	5.8	A
Total		1,372	1,347	98.2%	2.1	2.8	A

Intersection 21 **Santa Cruz Wy-Altos Av/Broadway** **Side-street Stop**

Direction	Movement	Demand Volume (vph)	Served Volume (vph)		Total Delay (sec/veh)		
			Average	Percent	Average	Std. Dev.	LOS
NB	Left Turn	6	9	150.4%	10.9	10.4	B
	Through						
	Right Turn	5	5	105.3%	3.5	3.0	A
	Subtotal	11	14	129.9%	9.7	7.5	A
SB	Left Turn	5	4	82.7%	18.1	24.5	C
	Through						
	Right Turn	2	2	112.8%	2.6	4.6	A
	Subtotal	7	6	91.3%	17.1	24.3	C
EB	Left Turn	2	2	94.0%	3.1	3.2	A
	Through	735	722	98.2%	2.0	1.5	A
	Right Turn	2	3	169.2%	1.9	1.5	A
	Subtotal	739	727	98.4%	2.0	1.6	A
WB	Left Turn	2	1	37.6%	2.1	3.6	A
	Through	554	540	97.5%	2.8	1.2	A
	Right Turn	4	3	75.2%	3.0	5.1	A
	Subtotal	560	544	97.1%	2.8	1.2	A
Total		1,317	1,292	98.1%	2.5	1.3	A

Intersection 22 **42nd St/Broadway** **Signal**

Direction	Movement	Demand Volume (vph)	Served Volume (vph)		Total Delay (sec/veh)		
			Average	Percent	Average	Std. Dev.	LOS
NB	Left Turn	44	49	111.1%	10.4	3.9	B
	Through	15	14	90.2%	9.3	3.1	A
	Right Turn	17	20	117.2%	7.0	3.1	A
	Subtotal	76	82	108.3%	9.5	2.7	A
SB	Left Turn	11	11	95.7%	9.8	7.1	A
	Through	5	6	112.8%	8.4	10.4	A
	Right Turn	6	6	94.0%	5.1	8.6	A
	Subtotal	22	22	99.1%	8.8	7.2	A
EB	Left Turn	11	10	88.9%	7.3	6.8	A
	Through	723	705	97.5%	5.2	1.0	A
	Right Turn	10	12	120.3%	4.5	4.2	A
	Subtotal	744	727	97.7%	5.3	1.0	A
WB	Left Turn	6	4	68.9%	7.2	7.5	A
	Through	517	508	98.2%	4.2	1.1	A
	Right Turn						
	Subtotal	523	512	97.8%	4.3	1.1	A
Total		1,365	1,343	98.4%	5.2	0.9	A

SimTraffic Post-Processor
Average Results from 10 Runs
Volume and Delay by Movement

Vision Zero Top 5 Corridors - Broadway & Stockton Bl
Existing Conditions
AM Peak Hour

Intersection 23 43rd St/Broadway Side-street Stop

Direction	Movement	Demand Volume (vph)	Served Volume (vph)		Total Delay (sec/veh)		
			Average	Percent	Average	Std. Dev.	LOS
NB	Left Turn	4	6	150.4%	9.6	9.6	A
	Through	2	2	112.8%	6.0	7.9	A
	Right Turn	19	20	102.9%	5.7	2.6	A
	Subtotal	25	28	111.3%	8.2	3.1	A
SB	Left Turn	2	2	94.0%	3.3	7.0	A
	Through	1	2	150.4%	14.8	24.5	B
	Right Turn	4	4	94.0%	3.9	6.8	A
	Subtotal	7	7	102.1%	10.0	10.6	B
EB	Left Turn	4	3	75.2%	2.0	2.1	A
	Through	746	732	98.1%	1.3	0.1	A
	Right Turn	1	1	112.8%	0.2	0.2	A
	Subtotal	751	736	98.0%	1.3	0.1	A
WB	Left Turn	5	6	120.3%	4.9	4.8	A
	Through	515	504	97.8%	0.9	0.5	A
	Right Turn	2	3	131.6%	0.8	0.4	A
	Subtotal	522	512	98.2%	1.0	0.6	A
Total		1,305	1,284	98.4%	1.4	0.3	A

Intersection 24 Stockton Bl/Broadway Signal

Direction	Movement	Demand Volume (vph)	Served Volume (vph)		Total Delay (sec/veh)		
			Average	Percent	Average	Std. Dev.	LOS
NB	Left Turn	216	193	89.3%	72.2	4.8	E
	Through	724	699	96.5%	44.6	5.5	D
	Right Turn	289	262	90.8%	42.5	8.2	D
	Subtotal	1,229	1,154	93.9%	48.7	4.9	D
SB	Left Turn	128	130	101.9%	52.7	7.4	D
	Through	200	204	101.9%	27.2	3.5	C
	Right Turn	46	52	113.6%	4.5	1.9	A
	Subtotal	374	387	103.3%	32.6	4.0	C
EB	Left Turn	132	136	103.1%	60.6	7.7	E
	Through	527	516	98.0%	39.4	5.1	D
	Right Turn	132	133	101.1%	6.8	1.8	A
	Subtotal	791	786	99.3%	37.5	4.2	D
WB	Left Turn	101	107	106.1%	57.9	5.6	E
	Through	233	235	100.7%	36.2	4.9	D
	Right Turn	101	112	110.6%	8.4	1.6	A
	Subtotal	435	453	104.2%	34.6	2.8	C
Total		2,829	2,780	98.3%	41.1	2.3	D

SimTraffic Post-Processor
Average Results from 10 Runs
Volume and Delay by Movement

Vision Zero Top 5 Corridors - Broadway & Stockton Bl
Existing Conditions
AM Peak Hour

Intersection 25 **Stockton Bl/7th Av** **Side-street Stop**

Direction	Movement	Demand Volume (vph)	Served Volume (vph)		Total Delay (sec/veh)		
			Average	Percent	Average	Std. Dev.	LOS
NB	Left Turn	27	27	100.3%	9.2	3.6	A
	Through	1,227	1,205	98.2%	8.5	3.1	A
	Right Turn	5	4	75.2%	2.1	1.1	A
	Subtotal	1,259	1,236	98.2%	8.5	3.1	A
SB	Left Turn	4	4	94.0%	16.4	16.9	C
	Through	426	440	103.2%	0.2	0.0	A
	Right Turn	2	1	56.4%	0.0	0.1	A
	Subtotal	432	444	102.9%	0.4	0.2	A
EB	Left Turn	2	0	18.8%	0.7	2.1	A
	Through	0	0	0.0%	0.0	0.0	A
	Right Turn	5	8	157.9%	2.8	1.5	A
	Subtotal	7	8	118.2%	2.9	1.6	A
WB	Left Turn	6	6	94.0%	37.0	30.7	E
	Through	0	0	0.0%	0.0	0.0	A
	Right Turn	12	13	106.5%	39.5	22.6	E
	Subtotal	18	18	102.4%	39.1	15.2	E
Total		1,716	1,707	99.5%	6.7	2.3	A

Intersection 26 **Stockton Bl/9th Av** **Side-street Stop**

Direction	Movement	Demand Volume (vph)	Served Volume (vph)		Total Delay (sec/veh)		
			Average	Percent	Average	Std. Dev.	LOS
NB	Left Turn	98	96	97.7%	6.2	1.4	A
	Through	1,163	1,135	97.6%	1.8	0.2	A
	Right Turn	2	3	131.6%	0.0	0.1	A
	Subtotal	1,263	1,234	97.7%	2.1	0.2	A
SB	Left Turn	8	10	130.4%	15.6	15.6	C
	Through	469	480	102.3%	0.5	0.1	A
	Right Turn	33	40	121.9%	0.1	0.2	A
	Subtotal	510	530	104.0%	0.9	0.5	A
EB	Left Turn	5	3	67.7%	5.6	7.8	A
	Through	0	0	0.0%	1.7	5.2	A
	Right Turn	16	19	116.9%	4.2	1.5	A
	Subtotal	21	22	105.6%	5.3	1.3	A
WB	Left Turn	2	1	56.4%	5.5	15.0	A
	Through	3	2	78.3%	26.4	7.8	D
	Right Turn	30	43	142.6%	22.0	7.5	C
	Subtotal	35	46	132.1%	22.0	7.4	C
Total		1,829	1,832	100.2%	2.3	0.3	A

Intersection 27 **Stockton Bl/11th Av** **Side-street Stop**

Direction	Movement	Demand Volume (vph)	Served Volume (vph)		Total Delay (sec/veh)		
			Average	Percent	Average	Std. Dev.	LOS
NB	Left Turn	5	6	120.3%	2.5	1.2	A
	Through	1,219	1,177	96.6%	1.0	0.2	A
	Right Turn	2	2	75.2%	0.0	0.0	A
	Subtotal	1,226	1,185	96.6%	1.0	0.2	A
SB	Left Turn	4	3	65.8%	6.6	13.3	A
	Through	471	484	102.8%	0.2	0.0	A
	Right Turn	2	1	56.4%	0.0	0.0	A
	Subtotal	477	488	102.3%	0.2	0.1	A
EB	Left Turn	8	7	89.3%	5.7	3.4	A
	Through	0	0	0.0%	0.0	0.0	A
	Right Turn	7	5	64.5%	2.9	1.5	A
	Subtotal	15	12	77.7%	4.8	2.7	A
WB	Left Turn	5	5	90.2%	22.8	25.8	C
	Through	0	0	0.0%	0.0	0.0	A
	Right Turn	25	29	115.8%	18.5	7.1	C
	Subtotal	30	33	111.5%	20.6	6.2	C
Total		1,748	1,718	98.3%	1.1	0.1	A

Intersection 28 **Stockton Bl/14th Av** **Signal**

Direction	Movement	Demand Volume (vph)	Served Volume (vph)		Total Delay (sec/veh)		
			Average	Percent	Average	Std. Dev.	LOS
NB	Left Turn	94	89	94.8%	121.9	15.8	F
	Through	1,087	1,039	95.6%	71.6	16.8	E
	Right Turn	64	55	85.8%	60.9	18.5	E
	Subtotal	1,245	1,183	95.0%	74.7	16.3	E
SB	Left Turn	70	75	107.4%	78.7	9.6	E
	Through	412	411	99.8%	32.6	5.1	C
	Right Turn	33	27	80.9%	29.4	9.9	C
	Subtotal	515	513	99.7%	39.3	4.5	D
EB	Left Turn	53	51	95.8%	55.6	11.8	E
	Through	175	185	105.9%	58.8	12.2	E
	Right Turn	64	69	108.1%	40.7	10.6	D
	Subtotal	292	305	104.6%	54.4	10.9	D
WB	Left Turn	55	59	106.6%	59.0	8.1	E
	Through	150	148	98.5%	65.6	12.6	E
	Right Turn	87	95	108.9%	55.7	17.5	E
	Subtotal	292	301	103.1%	61.3	11.8	E
Total		1,748	1,828	104.6%	62.3	10.1	E

SimTraffic Post-Processor
Average Results from 10 Runs
Volume and Delay by Movement

Vision Zero Top 5 Corridors - Stockton Bl
Existing Conditions
AM Peak Hour

Intersection 29

Stockton Bl/37th Av

Side-street Stop

Direction	Movement	Demand Volume (vph)	Served Volume (vph)		Total Delay (sec/veh)		
			Average	Percent	Average	Std. Dev.	LOS
NB	Left Turn	40	36	89.9%	5.2	1.3	A
	Through	1,178	1,115	94.7%	2.0	0.3	A
	Right Turn						
	Subtotal	1,218	1,151	94.5%	2.1	0.4	A
SB	Left Turn						
	Through	552	542	98.2%	1.4	0.2	A
	Right Turn	19	21	110.5%	1.4	0.7	A
	Subtotal	571	563	98.6%	1.4	0.2	A
EB	Left Turn	45	39	86.2%	19.5	6.3	C
	Through						
	Right Turn	47	44	93.2%	7.6	1.9	A
	Subtotal	92	83	89.8%	13.3	4.3	B
WB	Left Turn						
	Through						
	Right Turn						
	Subtotal						
Total		1,881	1,797	95.5%	2.4	0.4	A

Intersection 30

Stockton Bl/McMahon Dr

Signal

Direction	Movement	Demand Volume (vph)	Served Volume (vph)		Total Delay (sec/veh)		
			Average	Percent	Average	Std. Dev.	LOS
NB	Left Turn	1	1	106.8%	6.2	14.2	A
	Through	1,163	1,106	95.1%	7.3	1.9	A
	Right Turn	52	51	97.2%	6.3	2.3	A
	Subtotal	1,216	1,158	95.2%	7.2	1.9	A
SB	Left Turn	36	29	81.1%	22.9	8.1	C
	Through	550	541	98.4%	4.2	1.0	A
	Right Turn	13	16	126.0%	1.5	1.0	A
	Subtotal	599	587	97.9%	5.1	1.2	A
EB	Left Turn	3	2	59.3%	3.3	7.6	A
	Through	6	8	136.5%	17.4	15.1	B
	Right Turn	4	6	160.2%	6.0	9.5	A
	Subtotal	13	16	126.0%	11.1	7.1	B
WB	Left Turn	60	57	95.5%	16.2	4.4	B
	Through	9	7	79.1%	16.0	13.9	B
	Right Turn	52	46	89.0%	12.1	3.2	B
	Subtotal	121	111	91.5%	14.7	3.4	B
Total		1,949	1,871	96.0%	7.0	1.5	A

Intersection 31 Stockton Bl/Lemon Hill Av Signal

Direction	Movement	Demand Volume (vph)	Served Volume (vph)		Total Delay (sec/veh)		
			Average	Percent	Average	Std. Dev.	LOS
NB	Left Turn	37	34	91.4%	68.8	18.2	E
	Through	1,037	990	95.5%	30.6	11.3	C
	Right Turn	108	104	96.3%	13.2	5.0	B
	Subtotal	1,182	1,128	95.4%	30.2	10.9	C
SB	Left Turn	108	92	85.4%	40.7	6.4	D
	Through	455	464	102.0%	18.0	2.6	B
	Right Turn	51	47	92.1%	15.0	5.2	B
	Subtotal	614	603	98.3%	21.2	2.5	C
EB	Left Turn	47	46	97.0%	39.2	9.0	D
	Through	109	110	100.9%	40.5	7.0	D
	Right Turn	29	35	119.1%	6.7	2.1	A
	Subtotal	185	190	102.8%	34.1	5.9	C
WB	Left Turn	102	97	94.9%	34.3	6.8	C
	Through	93	88	94.2%	35.8	7.1	D
	Right Turn	158	165	104.5%	18.7	3.0	B
	Subtotal	353	350	99.0%	27.4	2.6	C
Total		2,334	2,271	97.3%	27.7	5.9	C

Intersection 32 Stockton Bl/Dias Av Signal

Direction	Movement	Demand Volume (vph)	Served Volume (vph)		Total Delay (sec/veh)		
			Average	Percent	Average	Std. Dev.	LOS
NB	Left Turn	19	17	89.9%	14.2	7.2	B
	Through	1,206	1,177	97.6%	9.6	1.5	A
	Right Turn	2	1	71.2%	3.0	6.2	A
	Subtotal	1,227	1,195	97.4%	9.6	1.5	A
SB	Left Turn	20	18	90.8%	18.0	6.0	B
	Through	558	559	100.2%	5.1	1.5	A
	Right Turn	17	16	96.3%	3.1	1.8	A
	Subtotal	595	593	99.7%	5.5	1.3	A
EB	Left Turn	2	2	106.8%	1.9	3.9	A
	Through						
	Right Turn	8	6	75.7%	4.9	5.4	A
	Subtotal	10	8	81.9%	5.3	5.3	A
WB	Left Turn	37	40	108.7%	17.3	2.8	B
	Through	1	0	35.6%	0.5	1.5	A
	Right Turn	54	56	104.2%	10.4	4.5	B
	Subtotal	92	97	105.3%	13.1	3.4	B
Total		1,924	1,894	98.4%	8.5	1.3	A

Intersection 33

Stockton Bl/47th Av-Elder Creek Rd

Signal

Direction	Movement	Demand Volume (vph)	Served Volume (vph)		Total Delay (sec/veh)		
			Average	Percent	Average	Std. Dev.	LOS
NB	Left Turn	222	237	106.6%	43.1	4.9	D
	Through	908	898	98.9%	36.4	7.6	D
	Right Turn	50	51	101.1%	15.4	6.3	B
	Subtotal	1,180	1,185	100.4%	36.9	6.6	D
SB	Left Turn	87	84	96.6%	47.3	8.2	D
	Through	331	336	101.4%	29.5	4.1	C
	Right Turn	189	184	97.6%	8.3	2.4	A
	Subtotal	607	604	99.5%	25.6	4.1	C
EB	Left Turn	222	223	100.5%	42.8	3.8	D
	Through	572	563	98.4%	31.6	3.4	C
	Right Turn	113	128	113.1%	24.7	5.6	C
	Subtotal	907	914	100.8%	33.4	2.4	C
WB	Left Turn	25	24	95.4%	60.5	10.0	E
	Through	635	596	93.8%	58.7	12.8	E
	Right Turn	101	89	88.5%	52.6	17.5	D
	Subtotal	761	709	93.1%	57.9	13.0	E
Total		3,455	3,412	98.8%	38.5	2.2	D

Intersection 34

Stockton Bl/Riza Av-Fowler Av

Signal

Direction	Movement	Demand Volume (vph)	Served Volume (vph)		Total Delay (sec/veh)		
			Average	Percent	Average	Std. Dev.	LOS
NB	Left Turn	15	14	90.2%	33.3	9.4	C
	Through	1,090	1,077	98.8%	12.6	2.1	B
	Right Turn	29	30	104.3%	11.2	2.0	B
	Subtotal	1,134	1,121	98.9%	12.8	2.1	B
SB	Left Turn	18	13	73.2%	35.9	11.5	D
	Through	403	438	108.6%	10.1	2.7	B
	Right Turn	15	16	104.4%	8.9	2.2	A
	Subtotal	436	466	107.0%	10.9	2.9	B
EB	Left Turn	28	25	90.3%	30.9	10.4	C
	Through	1	1	71.2%	29.5	10.4	C
	Right Turn	22	27	124.6%	5.7	3.0	A
	Subtotal	51	53	104.7%	17.6	5.8	B
WB	Left Turn	41	40	96.4%	26.9	6.3	C
	Through	1	1	142.4%	25.7	6.6	C
	Right Turn	34	37	109.9%	10.2	4.2	B
	Subtotal	76	78	103.1%	18.8	3.8	B
Total		1,697	1,719	101.3%	12.7	2.0	B

SimTraffic Post-Processor
Average Results from 10 Runs
Volume and Delay by Movement

Vision Zero Top 5 Corridors - Florin Rd
Existing Conditions
AM Peak Hour

Intersection 35 24th St/Florin Rd Signal

Direction	Movement	Demand Volume (vph)	Served Volume (vph)		Total Delay (sec/veh)		
			Average	Percent	Average	Std. Dev.	LOS
NB	Left Turn	160	150	94.0%	61.1	12.1	E
	Through	497	493	99.2%	33.5	2.3	C
	Right Turn	22	21	96.0%	25.4	7.5	C
	Subtotal	679	664	97.8%	39.6	4.0	D
SB	Left Turn	122	118	97.0%	49.1	8.9	D
	Through	254	269	105.9%	29.2	2.8	C
	Right Turn	312	312	99.9%	12.5	2.8	B
	Subtotal	688	699	101.6%	25.3	2.2	C
EB	Left Turn	353	302	85.6%	97.3	28.5	F
	Through	615	616	100.2%	25.7	3.6	C
	Right Turn	69	72	103.9%	19.7	4.7	B
	Subtotal	1,037	990	95.5%	47.2	11.1	D
WB	Left Turn	75	71	95.1%	44.9	5.9	D
	Through	575	541	94.1%	33.0	4.3	C
	Right Turn	121	115	95.1%	15.2	2.4	B
	Subtotal	771	728	94.4%	31.4	3.8	C
Total		3,175	3,081	97.0%	36.9	3.4	D

Intersection 36 Woodbine Av/Florin Rd Signal

Direction	Movement	Demand Volume (vph)	Served Volume (vph)		Total Delay (sec/veh)		
			Average	Percent	Average	Std. Dev.	LOS
NB	Left Turn	1	0	0.0%	0.0	0.0	A
	Through	2	1	36.4%	7.7	22.7	A
	Right Turn						
	Subtotal	3	1	24.3%	7.6	22.8	A
SB	Left Turn	26	23	89.6%	38.8	15.8	D
	Through	1	0	0.0%	3.3	10.4	A
	Right Turn	31	32	104.5%	7.5	2.3	A
	Subtotal	58	56	96.0%	21.8	8.9	C
EB	Left Turn	48	43	90.2%	51.4	11.0	D
	Through	927	920	99.3%	5.9	0.7	A
	Right Turn	6	6	103.1%	5.1	4.0	A
	Subtotal	981	970	98.8%	7.9	1.5	A
WB	Left Turn	2	1	72.8%	20.2	32.0	C
	Through	929	889	95.7%	10.8	2.5	B
	Right Turn	23	23	98.1%	11.3	4.8	B
	Subtotal	954	913	95.7%	10.9	2.5	B
Total		1,996	1,939	97.1%	9.7	1.4	A

Intersection 37 Indian Ln-29th St/Florin Rd Signal

Direction	Movement	Demand Volume (vph)	Served Volume (vph)		Total Delay (sec/veh)		
			Average	Percent	Average	Std. Dev.	LOS
NB	Left Turn	34	36	107.1%	35.9	8.0	D
	Through	9	10	109.2%	33.6	17.5	C
	Right Turn	291	296	101.8%	17.0	2.4	B
	Subtotal	334	343	102.6%	19.5	2.2	B
SB	Left Turn	79	78	98.1%	43.2	8.7	D
	Through	14	14	101.4%	43.6	23.7	D
	Right Turn	15	14	92.2%	7.4	4.0	A
	Subtotal	108	106	97.7%	38.9	7.5	D
EB	Left Turn	23	24	102.9%	44.4	10.9	D
	Through	913	885	97.0%	26.7	6.1	C
	Right Turn	33	31	93.8%	22.8	10.4	C
	Subtotal	969	940	97.0%	27.0	6.2	C
WB	Left Turn	152	151	99.4%	47.4	5.7	D
	Through	961	929	96.7%	14.4	4.3	B
	Right Turn	57	56	98.3%	4.3	0.9	A
	Subtotal	1,170	1,136	97.1%	18.2	4.0	B
Total		2,581	2,524	97.8%	22.6	4.1	C

Intersection 39 Hisperry Ln-Luther Burbank HS/Florin Rd Signal

Direction	Movement	Demand Volume (vph)	Served Volume (vph)		Total Delay (sec/veh)		
			Average	Percent	Average	Std. Dev.	LOS
NB	Left Turn	184	182	98.7%	39.0	3.7	D
	Through	1	0	0.0%	0.0	0.0	A
	Right Turn	89	87	97.7%	17.3	4.5	B
	Subtotal	274	269	98.0%	32.1	2.6	C
SB	Left Turn						
	Through						
	Right Turn						
	Subtotal						
EB	Left Turn						
	Through	991	971	98.0%	8.3	1.7	A
	Right Turn	8	10	127.4%	8.6	7.6	A
	Subtotal	999	981	98.2%	8.3	1.7	A
WB	Left Turn	148	146	98.6%	33.0	6.0	C
	Through	976	955	97.8%	10.1	1.8	B
	Right Turn	3	3	109.2%	4.7	2.8	A
	Subtotal	1,127	1,104	98.0%	13.1	2.3	B
Total		2,400	2,354	98.1%	13.2	1.4	B

Intersection 40 **Luther Dr/Florin Rd** **Signal**

Direction	Movement	Demand Volume (vph)	Served Volume (vph)		Total Delay (sec/veh)		
			Average	Percent	Average	Std. Dev.	LOS
NB	Left Turn	130	131	100.5%	37.9	2.8	D
	Through	48	48	100.3%	37.9	3.0	D
	Right Turn	170	171	100.8%	15.9	3.0	B
	Subtotal	348	350	100.6%	27.2	2.9	C
SB	Left Turn	64	64	99.7%	36.8	5.3	D
	Through	44	44	99.9%	37.1	5.1	D
	Right Turn	191	192	100.4%	13.0	2.3	B
	Subtotal	299	300	100.2%	21.6	1.7	C
EB	Left Turn	198	185	93.2%	61.9	6.1	E
	Through	842	833	99.0%	67.6	6.4	E
	Right Turn	59	52	88.4%	67.9	6.8	E
	Subtotal	1,099	1,070	97.4%	66.6	6.3	E
WB	Left Turn	101	99	98.4%	68.5	12.4	E
	Through	758	748	98.7%	42.0	11.7	D
	Right Turn	28	30	107.6%	42.1	11.1	D
	Subtotal	887	878	99.0%	45.1	11.2	D
Total		2,633	2,598	98.7%	48.8	4.9	D

Intersection 41 **Munson Wy/Florin Rd** **Signal**

Direction	Movement	Demand Volume (vph)	Served Volume (vph)		Total Delay (sec/veh)		
			Average	Percent	Average	Std. Dev.	LOS
NB	Left Turn						
	Through						
	Right Turn	106	102	95.8%	10.4	2.3	B
	Subtotal	106	102	95.8%	10.4	2.3	B
SB	Left Turn						
	Through						
	Right Turn						
	Subtotal						
EB	Left Turn	7	7	93.6%	9.8	8.0	A
	Through	1,067	1,044	97.8%	2.9	0.5	A
	Right Turn	47	48	103.0%	3.0	0.7	A
	Subtotal	1,121	1,099	98.0%	3.0	0.5	A
WB	Left Turn	59	53	89.5%	13.5	6.0	B
	Through	932	937	100.5%	0.6	0.2	A
	Right Turn	9	12	129.4%	0.0	0.1	A
	Subtotal	1,000	1,001	100.1%	1.3	0.4	A
Total		2,227	2,201	98.8%	2.6	0.4	A

SimTraffic Post-Processor
Average Results from 10 Runs
Volume and Delay by Movement

Vision Zero Top 5 Corridors - Marysville Bl
Existing Conditions
PM Peak Hour

Intersection 1 Marysville Bl/North Av Signal

Direction	Movement	Demand Volume (vph)	Served Volume (vph)		Total Delay (sec/veh)		
			Average	Percent	Average	Std. Dev.	LOS
NB	Left Turn	39	33	84.7%	35.1	6.8	D
	Through	1,035	962	93.0%	9.7	2.5	A
	Right Turn	31	25	79.3%	6.8	2.2	A
	Subtotal	1,105	1,020	92.3%	10.4	2.4	B
SB	Left Turn	41	38	93.7%	27.9	4.6	C
	Through	802	799	99.6%	9.0	1.5	A
	Right Turn	78	84	107.8%	5.6	2.3	A
	Subtotal	921	922	100.1%	9.5	1.5	A
EB	Left Turn	104	110	105.6%	17.4	2.8	B
	Through	11	7	66.3%	14.8	9.6	B
	Right Turn	49	45	92.5%	11.2	5.3	B
	Subtotal	164	162	99.0%	15.7	2.7	B
WB	Left Turn	30	29	96.0%	19.7	8.1	B
	Through	21	21	98.7%	20.3	6.3	C
	Right Turn	47	52	110.3%	9.0	3.0	A
	Subtotal	98	101	103.4%	14.1	2.6	B
Total		2,288	2,205	96.4%	10.6	1.6	B

Intersection 2 Marysville Bl/Harris Av Side-street Stop

Direction	Movement	Demand Volume (vph)	Served Volume (vph)		Total Delay (sec/veh)		
			Average	Percent	Average	Std. Dev.	LOS
NB	Left Turn	61	49	80.6%	8.9	3.8	A
	Through	1,024	960	93.8%	3.0	0.5	A
	Right Turn	16	13	79.2%	2.6	1.5	A
	Subtotal	1,101	1,022	92.8%	3.3	0.7	A
SB	Left Turn	51	52	101.6%	7.9	2.7	A
	Through	796	793	99.6%	2.5	0.3	A
	Right Turn	34	31	90.4%	2.0	0.7	A
	Subtotal	881	875	99.3%	2.8	0.2	A
EB	Left Turn	31	23	75.6%	25.3	8.8	D
	Through	13	13	97.5%	24.5	8.6	C
	Right Turn	31	31	100.3%	15.3	10.0	C
	Subtotal	75	67	89.6%	20.3	7.4	C
WB	Left Turn	3	2	76.8%	16.4	23.4	C
	Through	8	5	67.2%	15.3	11.3	C
	Right Turn	48	46	95.2%	9.6	3.3	A
	Subtotal	59	53	90.5%	11.0	4.3	B
Total		2,116	2,018	95.4%	3.9	0.4	A

Intersection 3 **Marysville Bl/Grand Av** **Signal**

Direction	Movement	Demand Volume (vph)	Served Volume (vph)		Total Delay (sec/veh)		
			Average	Percent	Average	Std. Dev.	LOS
NB	Left Turn	171	154	90.3%	41.0	8.1	D
	Through	961	901	93.8%	18.6	4.8	B
	Right Turn	55	46	84.5%	15.6	5.2	B
	Subtotal	1,187	1,102	92.8%	21.6	4.8	C
SB	Left Turn	58	60	103.9%	31.1	4.9	C
	Through	624	610	97.7%	16.9	3.3	B
	Right Turn	148	147	99.6%	13.4	5.0	B
	Subtotal	830	818	98.5%	17.4	3.2	B
EB	Left Turn	80	74	92.2%	29.0	6.4	C
	Through	95	97	102.3%	22.0	3.2	C
	Right Turn	121	122	100.9%	12.3	4.0	B
	Subtotal	296	293	99.0%	19.5	3.3	B
WB	Left Turn	40	41	102.7%	23.0	4.4	C
	Through	100	105	104.8%	19.0	4.1	B
	Right Turn	61	58	94.4%	11.7	3.5	B
	Subtotal	201	204	101.3%	18.1	1.8	B
Total		2,514	2,416	96.1%	19.6	3.2	B

Intersection 4 **Marysville Bl/Roanoke Av** **Side-street Stop**

Direction	Movement	Demand Volume (vph)	Served Volume (vph)		Total Delay (sec/veh)		
			Average	Percent	Average	Std. Dev.	LOS
NB	Left Turn	21	20	95.1%	24.7	16.0	C
	Through	1,157	1,077	93.1%	22.6	14.8	C
	Right Turn	30	28	93.4%	18.9	16.9	C
	Subtotal	1,208	1,125	93.1%	22.6	14.8	C
SB	Left Turn	22	18	83.8%	37.8	22.8	E
	Through	738	719	97.5%	19.1	10.7	C
	Right Turn	25	21	84.5%	17.6	10.1	C
	Subtotal	785	759	96.7%	19.5	10.8	C
EB	Left Turn	2	0	19.2%	42.8	80.4	E
	Through	1	1	76.8%	2.8	6.2	A
	Right Turn	25	22	86.0%	6.7	2.4	A
	Subtotal	28	23	80.9%	8.6	5.2	A
WB	Left Turn	14	11	79.5%	68.9	68.3	F
	Through	6	6	96.0%	25.7	26.5	D
	Right Turn	27	25	92.4%	68.2	76.9	F
	Subtotal	47	42	89.1%	67.6	66.8	F
Total		2,068	1,948	94.2%	22.3	13.2	C

SimTraffic Post-Processor
Average Results from 10 Runs
Volume and Delay by Movement

Vision Zero Top 5 Corridors - Marysville BI
Existing Conditions
PM Peak Hour

Intersection 5 Marysville BI/South Av Signal

Direction	Movement	Demand Volume (vph)	Served Volume (vph)		Total Delay (sec/veh)		
			Average	Percent	Average	Std. Dev.	LOS
NB	Left Turn	72	60	82.7%	29.6	4.6	C
	Through	1,131	1,055	93.3%	8.5	1.2	A
	Right Turn	35	33	93.3%	7.8	2.7	A
	Subtotal	1,238	1,147	92.7%	9.6	1.2	A
SB	Left Turn	25	31	122.9%	32.1	10.6	C
	Through	713	697	97.7%	8.8	1.6	A
	Right Turn	40	37	92.2%	6.7	3.2	A
	Subtotal	778	764	98.2%	9.6	1.6	A
EB	Left Turn	41	40	97.4%	23.0	6.1	C
	Through	24	26	108.8%	22.5	6.0	C
	Right Turn	41	37	90.8%	11.5	3.1	B
	Subtotal	106	103	97.4%	18.5	3.4	B
WB	Left Turn	20	18	88.3%	25.6	6.0	C
	Through	30	28	92.2%	22.3	5.3	C
	Right Turn	34	39	115.2%	10.9	3.5	B
	Subtotal	84	84	100.6%	17.7	3.4	B
Total		2,206	2,099	95.1%	10.3	1.1	B

Intersection 6 Marysville BI/Los Robles BI (N) Side-street Stop

Direction	Movement	Demand Volume (vph)	Served Volume (vph)		Total Delay (sec/veh)		
			Average	Percent	Average	Std. Dev.	LOS
NB	Left Turn	62	59	94.8%	6.8	0.9	A
	Through	1,246	1,163	93.3%	2.0	0.4	A
	Right Turn						
	Subtotal	1,308	1,222	93.4%	2.3	0.4	A
SB	Left Turn						
	Through	728	699	96.0%	0.4	0.1	A
	Right Turn	46	46	101.0%	0.1	0.1	A
	Subtotal	774	745	96.3%	0.4	0.1	A
EB	Left Turn	21	19	89.6%	13.0	8.4	B
	Through						
	Right Turn	62	69	111.5%	6.4	1.9	A
	Subtotal	83	88	105.9%	7.8	2.5	A
WB	Left Turn						
	Through						
	Right Turn						
	Subtotal						
Total		2,165	2,055	94.9%	1.8	0.3	A

Intersection 7 **Marysville BI/Los Robles BI (S)** **Signal**

Direction	Movement	Demand Volume (vph)	Served Volume (vph)		Total Delay (sec/veh)		
			Average	Percent	Average	Std. Dev.	LOS
NB	Left Turn	2	1	57.6%	5.3	8.7	A
	Through	1,251	1,156	92.4%	6.3	1.0	A
	Right Turn	28	26	91.9%	5.1	1.9	A
	Subtotal	1,281	1,183	92.4%	6.2	1.0	A
SB	Left Turn	32	32	100.8%	18.1	4.6	B
	Through	739	713	96.5%	4.5	0.4	A
	Right Turn	19	19	99.0%	2.6	1.9	A
	Subtotal	790	764	96.7%	5.0	0.4	A
EB	Left Turn	19	18	95.0%	10.7	7.1	B
	Through	2	0	19.2%	0.2	0.5	A
	Right Turn	1	2	192.0%	1.8	3.1	A
	Subtotal	22	20	92.5%	10.0	6.5	B
WB	Left Turn	54	59	109.5%	12.7	2.3	B
	Through	3	3	89.6%	7.3	9.3	A
	Right Turn	38	41	107.1%	6.6	3.0	A
	Subtotal	95	103	107.9%	10.3	2.2	B
Total		2,188	2,070	94.6%	6.0	0.8	A

Intersection 8 **Marysville BI/Arcade BI** **Signal**

Direction	Movement	Demand Volume (vph)	Served Volume (vph)		Total Delay (sec/veh)		
			Average	Percent	Average	Std. Dev.	LOS
NB	Left Turn	9	6	64.0%	47.6	29.4	D
	Through	683	681	99.7%	37.3	4.7	D
	Right Turn	26	26	99.0%	29.6	6.9	C
	Subtotal	718	712	99.2%	37.1	4.4	D
SB	Left Turn	407	397	97.6%	41.2	5.7	D
	Through	355	338	95.3%	14.8	2.2	B
	Right Turn	31	33	106.5%	8.1	5.2	A
	Subtotal	793	768	96.9%	28.1	3.3	C
EB	Left Turn	40	35	88.3%	37.3	14.8	D
	Through	103	111	108.1%	27.9	4.8	C
	Right Turn	9	8	89.6%	4.7	5.3	A
	Subtotal	152	155	101.8%	29.4	5.0	C
WB	Left Turn	32	28	86.4%	81.6	27.0	F
	Through	146	114	78.1%	77.9	28.5	E
	Right Turn	575	507	88.2%	66.5	27.7	E
	Subtotal	753	649	86.2%	69.0	27.6	E
Total		2,416	2,284	94.6%	42.4	8.8	D

SimTraffic Post-Processor
Average Results from 10 Runs
Volume and Delay by Movement

Vision Zero Top 5 Corridors - Marysville BI
Existing Conditions
PM Peak Hour

Intersection 9 Del Paso BI/Arcade BI Signal

Direction	Movement	Demand Volume (vph)	Served Volume (vph)		Total Delay (sec/veh)		
			Average	Percent	Average	Std. Dev.	LOS
NB	Left Turn	19	22	115.2%	36.8	14.8	D
	Through	73	74	101.0%	33.1	5.6	C
	Right Turn	116	116	100.0%	8.4	2.0	A
	Subtotal	208	212	101.7%	19.8	2.8	B
SB	Left Turn	134	145	108.0%	32.0	6.2	C
	Through	24	23	96.0%	27.2	7.6	C
	Right Turn	25	22	89.1%	16.0	8.8	B
	Subtotal	183	190	103.9%	29.5	6.1	C
EB	Left Turn	8	7	86.4%	55.2	26.3	E
	Through	514	499	97.0%	23.2	6.1	C
	Right Turn	6	3	57.6%	10.2	13.8	B
	Subtotal	528	509	96.4%	23.7	5.9	C
WB	Left Turn	85	90	105.7%	31.2	6.5	C
	Through	719	704	97.9%	16.8	2.7	B
	Right Turn	183	188	102.8%	3.6	0.2	A
	Subtotal	987	982	99.5%	15.6	2.2	B
Total		1,906	1,893	99.3%	19.6	3.0	B

Intersection 10 Marysville BI/Sonoma Av Side-street Stop

Direction	Movement	Demand Volume (vph)	Served Volume (vph)		Total Delay (sec/veh)		
			Average	Percent	Average	Std. Dev.	LOS
NB	Left Turn	26	31	121.1%	3.5	1.7	A
	Through	679	652	96.0%	1.2	0.4	A
	Right Turn	8	9	115.2%	0.4	0.5	A
	Subtotal	713	693	97.2%	1.3	0.5	A
SB	Left Turn	13	15	115.2%	4.9	2.4	A
	Through	372	350	94.1%	0.7	0.1	A
	Right Turn	25	18	73.7%	0.2	0.2	A
	Subtotal	410	384	93.6%	0.8	0.2	A
EB	Left Turn	31	33	106.5%	14.8	3.6	B
	Through	6	5	76.8%	13.3	17.2	B
	Right Turn	11	9	83.8%	5.1	4.4	A
	Subtotal	48	47	97.6%	13.8	3.3	B
WB	Left Turn	3	4	128.0%	9.5	11.6	A
	Through	6	7	121.6%	7.8	7.3	A
	Right Turn	17	23	133.3%	5.5	1.7	A
	Subtotal	26	34	130.0%	7.8	2.7	A
Total		1,197	1,157	96.7%	1.8	0.4	A

SimTraffic Post-Processor
Average Results from 10 Runs
Volume and Delay by Movement

Vision Zero Top 5 Corridors - Marysville BI
Existing Conditions
PM Peak Hour

Intersection 11 Marysville BI/Del Paso BI Signal

Direction	Movement	Demand Volume (vph)	Served Volume (vph)		Total Delay (sec/veh)		
			Average	Percent	Average	Std. Dev.	LOS
NB	Left Turn						
	Through	637	617	96.9%	5.8	0.8	A
	Right Turn	216	207	95.8%	2.3	0.3	A
	Subtotal	853	824	96.6%	4.9	0.6	A
SB	Left Turn	18	17	93.9%	14.8	5.2	B
	Through	345	319	92.6%	4.4	1.5	A
	Right Turn						
	Subtotal	363	336	92.7%	4.9	1.5	A
EB	Left Turn						
	Through						
	Right Turn						
	Subtotal						
WB	Left Turn	124	118	94.8%	9.3	1.3	A
	Through						
	Right Turn	26	37	141.8%	3.6	0.5	A
	Subtotal	150	154	102.9%	7.9	0.8	A
Total		1,366	1,315	96.3%	5.3	0.6	A

SimTraffic Post-Processor
Average Results from 10 Runs
Volume and Delay by Movement

Vision Zero Top 5 Corridors - El Camino Av
Existing Conditions
PM Peak Hour

Intersection 12 Colfax St/El Camino Av Signal

Direction	Movement	Demand Volume (vph)	Served Volume (vph)		Total Delay (sec/veh)		LOS
			Average	Percent	Average	Std. Dev.	
NB	Left Turn	43	35	82.1%	14.7	5.8	B
	Through	15	12	80.2%	15.6	8.5	B
	Right Turn	23	22	94.5%	6.4	4.8	A
	Subtotal	81	69	85.3%	12.3	4.0	B
SB	Left Turn	2	2	97.0%	4.5	10.5	A
	Through	7	6	88.7%	9.7	9.2	A
	Right Turn	25	31	122.6%	7.1	3.4	A
	Subtotal	34	39	114.1%	8.0	4.2	A
EB	Left Turn	38	36	93.9%	11.7	2.8	B
	Through	585	591	101.1%	6.6	1.8	A
	Right Turn	26	26	98.5%	5.0	3.8	A
	Subtotal	649	653	100.6%	6.8	1.9	A
WB	Left Turn	12	13	106.7%	9.4	4.6	A
	Through	596	571	95.8%	5.7	1.4	A
	Right Turn	4	3	87.3%	2.5	3.2	A
	Subtotal	612	587	95.9%	5.8	1.4	A
Total		1,376	1,348	97.9%	6.7	1.1	A

Intersection 13 Grove Av/El Camino Av Signal

Direction	Movement	Demand Volume (vph)	Served Volume (vph)		Total Delay (sec/veh)		LOS
			Average	Percent	Average	Std. Dev.	
NB	Left Turn	52	51	98.5%	41.0	7.2	D
	Through	278	283	101.9%	41.0	5.8	D
	Right Turn	35	44	125.3%	32.4	11.3	C
	Subtotal	365	378	103.6%	40.0	5.2	D
SB	Left Turn	85	74	87.6%	41.9	5.4	D
	Through	140	139	98.9%	43.5	3.2	D
	Right Turn	65	73	112.8%	31.1	5.4	C
	Subtotal	290	286	98.7%	40.0	2.4	D
EB	Left Turn	54	60	110.7%	101.0	20.3	F
	Through	516	516	100.1%	45.2	17.5	D
	Right Turn	22	20	91.7%	38.0	24.5	D
	Subtotal	592	596	100.7%	50.6	17.4	D
WB	Left Turn	21	24	112.7%	114.3	42.8	F
	Through	497	470	94.5%	83.0	18.7	F
	Right Turn	47	44	94.1%	78.3	23.3	E
	Subtotal	565	538	95.2%	83.7	19.0	F
Total		1,812	1,799	99.3%	56.5	8.8	E

Intersection 14 Hawthorne Av-Altos Av/El Camino Av Side-street Stop

Direction	Movement	Demand Volume (vph)	Served Volume (vph)		Total Delay (sec/veh)		
			Average	Percent	Average	Std. Dev.	LOS
EB	Left Turn	52	47	89.5%	26.0	8.1	D
	Through	584	589	100.8%	8.5	1.5	A
	Right Turn						
	Subtotal	636	635	99.9%	9.8	1.5	A
SB	Left Turn	7	5	66.5%	53.9	52.4	F
	Through	19	19	100.1%	77.1	36.5	F
	Right Turn	1	1	77.6%	69.2	43.3	F
	Subtotal	27	24	90.5%	72.9	35.3	F
SE	Left Turn	8	5	63.1%	28.6	26.6	D
	Through						
	Right Turn	5	5	93.1%	48.3	39.8	E
	Subtotal	13	10	74.6%	47.7	35.3	E
WB	Left Turn						
	Through	541	519	96.0%	47.4	16.7	E
	Right Turn	46	46	100.4%	44.2	16.3	E
	Subtotal	587	565	96.3%	47.1	16.7	E
Total		1,263	1,235	97.8%	28.2	7.4	D

Intersection 15 Forrest St/El Camino Av Side-street Stop

Direction	Movement	Demand Volume (vph)	Served Volume (vph)		Total Delay (sec/veh)		
			Average	Percent	Average	Std. Dev.	LOS
NB	Left Turn	6	5	84.1%	45.7	61.0	E
	Through						
	Right Turn	17	15	89.0%	12.2	12.2	B
	Subtotal	23	20	87.7%	18.3	16.6	C
SB	Left Turn						
	Through						
	Right Turn						
	Subtotal						
EB	Left Turn						
	Through	611	609	99.7%	1.1	0.4	A
	Right Turn	18	20	112.1%	0.7	0.7	A
	Subtotal	629	629	100.1%	1.0	0.4	A
WB	Left Turn	11	10	91.7%	14.8	11.0	B
	Through	591	584	98.9%	11.5	8.3	B
	Right Turn						
	Subtotal	602	594	98.7%	11.6	8.2	B
Total		1,254	1,244	99.2%	6.3	3.7	A

SimTraffic Post-Processor
Average Results from 10 Runs
Volume and Delay by Movement

Vision Zero Top 5 Corridors - El Camino Av
Existing Conditions
PM Peak Hour

Intersection 16 Cantalier St/El Camino Av Side-street Stop

Direction	Movement	Demand Volume (vph)	Served Volume (vph)		Total Delay (sec/veh)		
			Average	Percent	Average	Std. Dev.	LOS
NB	Left Turn	9	7	81.9%	9.5	9.2	A
	Through						
	Right Turn	22	20	89.9%	8.5	5.9	A
	Subtotal	31	27	87.6%	9.9	6.0	A
SB	Left Turn						
	Through						
	Right Turn						
	Subtotal						
EB	Left Turn						
	Through	622	614	98.7%	1.0	0.3	A
	Right Turn	2	3	135.8%	0.3	0.4	A
	Subtotal	624	617	98.9%	1.0	0.3	A
WB	Left Turn	8	5	67.9%	6.1	4.6	A
	Through	610	630	103.2%	2.2	0.8	A
	Right Turn						
	Subtotal	618	635	102.8%	2.3	0.9	A
Total		1,273	1,279	100.5%	1.8	0.4	A

Intersection 17 Rio Linda Bl/El Camino Av Signal

Direction	Movement	Demand Volume (vph)	Served Volume (vph)		Total Delay (sec/veh)		
			Average	Percent	Average	Std. Dev.	LOS
NB	Left Turn	10	13	128.0%	31.1	7.2	C
	Through	54	51	94.8%	25.0	4.4	C
	Right Turn	4	4	106.7%	10.1	14.8	B
	Subtotal	68	68	100.4%	25.6	4.0	C
SB	Left Turn	21	15	70.2%	17.2	11.1	B
	Through	61	60	98.6%	25.3	4.3	C
	Right Turn	44	52	117.3%	13.1	3.8	B
	Subtotal	126	126	100.4%	19.6	2.9	B
EB	Left Turn	65	65	100.3%	19.7	3.0	B
	Through	571	556	97.4%	6.8	2.1	A
	Right Turn	8	8	97.0%	6.6	6.5	A
	Subtotal	644	629	97.7%	8.1	1.8	A
WB	Left Turn	11	8	74.1%	13.7	8.8	B
	Through	564	568	100.8%	10.0	2.3	B
	Right Turn	12	11	93.8%	8.7	5.8	A
	Subtotal	587	588	100.1%	10.1	2.3	B
Total		1,425	1,412	99.1%	10.8	1.0	B

Intersection 18

Del Paso Bl-Beaumont St/El Camino Av

Signal

Direction	Movement	Demand Volume (vph)	Served Volume (vph)		Total Delay (sec/veh)		
			Average	Percent	Average	Std. Dev.	LOS
NB	Left Turn						
	Through	383	388	101.4%	45.5	4.2	D
	Right Turn	82	84	102.2%	43.0	6.9	D
	Subtotal	465	472	101.5%	45.1	4.2	D
SB	Left Turn	116	128	110.4%	50.1	7.4	D
	Through	170	148	87.0%	26.0	3.3	C
	Right Turn	64	61	95.8%	12.8	4.1	B
	Subtotal	350	337	96.3%	32.8	3.0	C
EB	Left Turn	99	85	85.4%	61.9	14.1	E
	Through	482	454	94.2%	29.4	8.3	C
	Right Turn	15	15	98.3%	13.8	11.8	B
	Subtotal	596	553	92.8%	33.8	8.2	C
WB	Left Turn	84	69	82.2%	55.0	9.3	D
	Through	523	518	99.0%	37.3	5.9	D
	Right Turn	85	81	95.9%	3.3	0.6	A
	Subtotal	692	668	96.6%	34.9	4.7	C
Total		2,103	2,031	96.6%	36.7	3.1	D

Intersection 19

Martin Luther King Jr BI/Broadway

Signal

Direction	Movement	Demand Volume (vph)	Served Volume (vph)		Total Delay (sec/veh)		
			Average	Percent	Average	Std. Dev.	LOS
NB	Left Turn	156	149	95.7%	27.2	2.6	C
	Through						
	Right Turn	114	105	92.4%	5.9	1.0	A
	Subtotal	270	255	94.3%	18.3	1.7	B
SB	Left Turn						
	Through						
	Right Turn						
	Subtotal						
EB	Left Turn						
	Through	588	591	100.6%	12.4	1.7	B
	Right Turn	336	319	95.0%	11.7	1.8	B
	Subtotal	924	911	98.6%	12.2	1.5	B
WB	Left Turn	281	259	92.2%	29.0	7.8	C
	Through	543	546	100.5%	9.9	3.3	A
	Right Turn						
	Subtotal	824	805	97.7%	15.9	3.8	B
Total		2,018	1,970	97.6%	14.5	1.7	B

Intersection 20

39th St/Broadway

Side-street Stop

Direction	Movement	Demand Volume (vph)	Served Volume (vph)		Total Delay (sec/veh)		
			Average	Percent	Average	Std. Dev.	LOS
NB	Left Turn	1	0	0.0%	0.0	0.0	A
	Through						
	Right Turn	3	3	112.8%	3.4	4.6	A
	Subtotal	4	3	84.6%	3.4	4.6	A
SB	Left Turn	1	0	0.0%	1.3	4.0	A
	Through						
	Right Turn	11	11	102.5%	8.0	8.3	A
	Subtotal	12	11	94.0%	8.0	8.3	A
EB	Left Turn	10	10	101.5%	6.1	2.5	A
	Through	686	676	98.6%	3.3	1.8	A
	Right Turn	6	8	125.3%	3.1	1.7	A
	Subtotal	702	694	98.9%	3.3	1.7	A
WB	Left Turn	18	17	94.0%	5.5	2.8	A
	Through	811	808	99.6%	2.3	1.8	A
	Right Turn	3	2	62.7%	0.8	0.8	A
	Subtotal	832	827	99.4%	2.4	1.8	A
Total		1,550	1,536	99.1%	2.8	1.8	A

Intersection 21 **Santa Cruz Wy-Altos Av/Broadway** **Side-street Stop**

Direction	Movement	Demand Volume (vph)	Served Volume (vph)		Total Delay (sec/veh)		
			Average	Percent	Average	Std. Dev.	LOS
NB	Left Turn	2	1	56.4%	4.6	8.1	A
	Through						
	Right Turn	5	3	67.7%	4.9	7.0	A
	Subtotal	7	5	64.5%	5.7	7.4	A
SB	Left Turn	3	2	75.2%	7.1	10.0	A
	Through						
	Right Turn	3	4	125.3%	1.6	2.0	A
	Subtotal	6	6	100.3%	6.1	5.4	A
EB	Left Turn	3	4	125.3%	3.9	3.5	A
	Through	671	653	97.3%	0.8	0.1	A
	Right Turn	5	6	112.8%	0.7	0.1	A
	Subtotal	679	663	97.6%	0.9	0.2	A
WB	Left Turn	6	6	94.0%	4.0	5.0	A
	Through	817	828	101.3%	0.6	0.2	A
	Right Turn						
	Subtotal	823	834	101.3%	0.6	0.3	A
Total		1,515	1,507	99.4%	0.8	0.2	A

Intersection 22 **42nd St/Broadway** **Signal**

Direction	Movement	Demand Volume (vph)	Served Volume (vph)		Total Delay (sec/veh)		
			Average	Percent	Average	Std. Dev.	LOS
NB	Left Turn	9	10	108.6%	6.0	4.4	A
	Through	10	10	101.5%	10.6	7.8	B
	Right Turn	10	8	82.7%	2.0	1.4	A
	Subtotal	29	28	97.2%	7.7	2.8	A
SB	Left Turn	7	6	91.3%	4.6	4.7	A
	Through	9	9	104.4%	9.2	7.8	A
	Right Turn	13	12	89.7%	2.7	1.7	A
	Subtotal	29	27	94.6%	6.3	3.9	A
EB	Left Turn	9	8	83.6%	11.2	16.2	B
	Through	639	616	96.4%	4.0	1.3	A
	Right Turn	22	22	100.8%	4.0	4.3	A
	Subtotal	670	646	96.4%	4.1	1.4	A
WB	Left Turn	22	22	99.1%	11.5	5.9	B
	Through	812	822	101.3%	4.1	0.7	A
	Right Turn	6	6	100.3%	3.1	4.8	A
	Subtotal	840	850	101.2%	4.3	0.7	A
Total		1,568	1,551	98.9%	4.3	0.8	A

SimTraffic Post-Processor
Average Results from 10 Runs
Volume and Delay by Movement

Vision Zero Top 5 Corridors - Broadway & Stockton Bl
Existing Conditions
PM Peak Hour

Intersection 23 43rd St/Broadway Side-street Stop

Direction	Movement	Demand Volume (vph)	Served Volume (vph)		Total Delay (sec/veh)		
			Average	Percent	Average	Std. Dev.	LOS
NB	Left Turn	4	3	84.6%	9.0	11.2	A
	Through	1	0	0.0%	0.0	0.0	A
	Right Turn	7	6	80.6%	7.4	7.4	A
	Subtotal	12	9	75.2%	9.3	8.0	A
SB	Left Turn	2	0	18.8%	4.0	12.6	A
	Through						
	Right Turn	4	2	56.4%	2.7	4.3	A
	Subtotal	6	3	43.9%	6.7	12.4	A
EB	Left Turn	4	4	94.0%	9.1	10.2	A
	Through	647	626	96.7%	1.2	0.4	A
	Right Turn	5	5	105.3%	0.7	0.8	A
	Subtotal	656	635	96.8%	1.3	0.4	A
WB	Left Turn	12	15	125.3%	6.1	3.3	A
	Through	832	847	101.8%	1.8	0.5	A
	Right Turn	8	9	108.1%	1.6	0.4	A
	Subtotal	852	870	102.2%	1.9	0.6	A
Total		1,526	1,517	99.4%	1.7	0.5	A

Intersection 24 Stockton Bl/Broadway Signal

Direction	Movement	Demand Volume (vph)	Served Volume (vph)		Total Delay (sec/veh)		
			Average	Percent	Average	Std. Dev.	LOS
NB	Left Turn	170	173	101.7%	47.8	8.8	D
	Through	298	288	96.6%	30.2	5.3	C
	Right Turn	104	105	100.5%	24.9	6.5	C
	Subtotal	572	566	98.9%	34.6	5.1	C
SB	Left Turn	110	108	97.8%	57.5	9.2	E
	Through	708	688	97.1%	35.2	4.0	D
	Right Turn	171	170	99.6%	11.6	2.7	B
	Subtotal	989	966	97.6%	33.7	4.0	C
EB	Left Turn	70	68	97.8%	54.0	7.0	D
	Through	248	238	96.1%	36.1	6.8	D
	Right Turn	327	309	94.6%	19.8	4.7	B
	Subtotal	645	616	95.5%	30.0	4.3	C
WB	Left Turn	210	218	103.7%	53.4	9.3	D
	Through	499	506	101.3%	34.7	3.1	C
	Right Turn	121	127	105.3%	8.8	1.8	A
	Subtotal	830	851	102.5%	35.7	4.3	D
Total		3,036	2,998	98.8%	33.6	3.3	C

SimTraffic Post-Processor
Average Results from 10 Runs
Volume and Delay by Movement

Vision Zero Top 5 Corridors - Broadway & Stockton Bl
Existing Conditions
PM Peak Hour

Intersection 25 **Stockton Bl/7th Av** **Side-street Stop**

Direction	Movement	Demand Volume (vph)	Served Volume (vph)		Total Delay (sec/veh)		
			Average	Percent	Average	Std. Dev.	LOS
NB	Left Turn	12	11	94.0%	10.8	7.2	B
	Through	534	534	100.1%	0.8	0.2	A
	Right Turn	5	5	97.8%	0.3	0.1	A
	Subtotal	551	550	99.9%	1.0	0.4	A
SB	Left Turn	17	14	81.8%	5.1	3.8	A
	Through	1,270	1,239	97.6%	0.6	0.1	A
	Right Turn	6	3	50.1%	0.0	0.1	A
	Subtotal	1,293	1,256	97.2%	0.6	0.1	A
EB	Left Turn	5	4	75.2%	13.6	12.5	B
	Through	0	0	0.0%	0.0	0.0	A
	Right Turn	6	6	94.0%	6.0	6.6	A
	Subtotal	11	9	85.5%	12.3	8.2	B
WB	Left Turn	2	1	37.6%	0.6	1.9	A
	Through	0	0	0.0%	0.0	0.0	A
	Right Turn	7	8	112.8%	3.9	2.4	A
	Subtotal	9	9	96.1%	4.0	2.4	A
Total		1,864	1,825	97.9%	0.8	0.2	A

Intersection 26 **Stockton Bl/9th Av** **Side-street Stop**

Direction	Movement	Demand Volume (vph)	Served Volume (vph)		Total Delay (sec/veh)		
			Average	Percent	Average	Std. Dev.	LOS
NB	Left Turn	10	10	104.3%	17.0	13.3	C
	Through	523	527	100.8%	0.6	0.1	A
	Right Turn	4	5	122.2%	0.1	0.2	A
	Subtotal	537	542	101.0%	0.9	0.3	A
SB	Left Turn	29	30	103.4%	4.7	1.8	A
	Through	1,241	1,206	97.2%	0.8	0.2	A
	Right Turn	24	20	83.0%	0.0	0.0	A
	Subtotal	1,294	1,256	97.1%	0.9	0.2	A
EB	Left Turn	8	6	75.2%	21.9	22.1	C
	Through	0	0	0.0%	1.4	4.4	A
	Right Turn	18	16	91.4%	12.2	6.9	B
	Subtotal	26	23	86.8%	14.9	7.8	B
WB	Left Turn	3	3	112.8%	3.3	3.3	A
	Through	0	0	0.0%	0.9	2.7	A
	Right Turn	19	17	88.6%	5.6	3.7	A
	Subtotal	22	20	92.3%	5.5	3.0	A
Total		1,879	1,841	98.0%	1.1	0.2	A

SimTraffic Post-Processor
Average Results from 10 Runs
Volume and Delay by Movement

Vision Zero Top 5 Corridors - Broadway & Stockton Bl
Existing Conditions
PM Peak Hour

Intersection 27

Stockton Bl/11th Av

Side-street Stop

Direction	Movement	Demand Volume (vph)	Served Volume (vph)		Total Delay (sec/veh)		
			Average	Percent	Average	Std. Dev.	LOS
NB	Left Turn	12	14	112.8%	16.9	11.0	C
	Through	534	537	100.6%	0.4	0.1	A
	Right Turn	1	2	150.4%	0.0	0.0	A
	Subtotal	547	552	101.0%	0.8	0.4	A
SB	Left Turn	21	17	82.4%	5.9	4.6	A
	Through	1,215	1,176	96.8%	1.7	1.5	A
	Right Turn	10	11	105.3%	0.5	1.5	A
	Subtotal	1,246	1,204	96.6%	1.8	1.4	A
EB	Left Turn	5	6	112.8%	25.4	22.2	D
	Through	0	0	0.0%	0.0	0.0	A
	Right Turn	9	6	66.8%	11.1	12.5	B
	Subtotal	14	12	83.3%	22.4	12.7	C
WB	Left Turn	8	7	84.6%	8.0	10.9	A
	Through	0	0	0.0%	0.0	0.0	A
	Right Turn	5	7	135.4%	4.5	4.6	A
	Subtotal	13	14	104.1%	7.5	7.1	A
Total		1,820	1,781	97.9%	1.7	0.9	A

Intersection 28

Stockton Bl/14th Av

Signal

Direction	Movement	Demand Volume (vph)	Served Volume (vph)		Total Delay (sec/veh)		
			Average	Percent	Average	Std. Dev.	LOS
NB	Left Turn	100	98	98.1%	63.8	9.2	E
	Through	451	466	103.4%	34.7	4.0	C
	Right Turn	81	82	100.7%	27.7	6.8	C
	Subtotal	632	646	102.2%	38.2	3.5	D
SB	Left Turn	96	89	92.4%	136.8	18.0	F
	Through	1,022	915	89.5%	66.5	15.8	E
	Right Turn	66	55	83.7%	64.7	13.7	E
	Subtotal	1,184	1,059	89.4%	72.2	16.3	E
EB	Left Turn	53	47	88.0%	49.8	9.1	D
	Through	163	159	97.8%	58.7	9.2	E
	Right Turn	94	85	90.8%	48.7	14.0	D
	Subtotal	310	291	94.0%	54.2	8.3	D
WB	Left Turn	100	96	95.5%	68.7	14.2	E
	Through	190	176	92.8%	72.5	18.4	E
	Right Turn	74	74	100.1%	60.1	18.1	E
	Subtotal	364	346	95.0%	69.0	16.3	E
Total		1,820	1,895	104.1%	60.1	10.1	E

SimTraffic Post-Processor
Average Results from 10 Runs
Volume and Delay by Movement

Vision Zero Top 5 Corridors - Stockton Bl
Existing Conditions
PM Peak Hour

Intersection 29

Stockton Bl/37th Av

Side-street Stop

Direction	Movement	Demand Volume (vph)	Served Volume (vph)		Total Delay (sec/veh)		
			Average	Percent	Average	Std. Dev.	LOS
NB	Left Turn	37	31	84.2%	13.9	4.4	B
	Through	797	733	92.0%	1.7	0.3	A
	Right Turn						
	Subtotal	834	765	91.7%	2.2	0.5	A
SB	Left Turn	4	3	76.0%	3.3	3.5	A
	Through	1,131	1,119	98.9%	3.4	0.4	A
	Right Turn	109	115	105.3%	3.2	0.8	A
	Subtotal	1,244	1,237	99.4%	3.4	0.4	A
EB	Left Turn	48	48	99.0%	36.8	8.4	E
	Through						
	Right Turn	41	41	99.2%	22.2	12.9	C
	Subtotal	89	88	99.1%	29.3	10.1	D
WB	Left Turn	8	4	52.3%	20.2	19.4	C
	Through						
	Right Turn	6	5	82.3%	7.9	6.7	A
	Subtotal	14	9	65.1%	14.9	12.1	B
Total		2,181	2,098	96.2%	4.2	0.7	A

Intersection 30

Stockton Bl/McMahon Dr

Signal

Direction	Movement	Demand Volume (vph)	Served Volume (vph)		Total Delay (sec/veh)		
			Average	Percent	Average	Std. Dev.	LOS
NB	Left Turn	12	11	91.8%	26.5	9.0	C
	Through	742	674	90.9%	10.1	4.0	B
	Right Turn	58	61	105.5%	7.9	2.8	A
	Subtotal	812	746	91.9%	10.1	3.8	B
SB	Left Turn	32	26	80.8%	24.6	7.3	C
	Through	1,123	1,112	99.0%	7.0	1.0	A
	Right Turn	25	23	91.2%	5.9	2.3	A
	Subtotal	1,180	1,160	98.3%	7.3	1.1	A
EB	Left Turn	64	67	105.1%	16.4	3.0	B
	Through	17	16	93.9%	19.4	10.6	B
	Right Turn	38	38	101.0%	12.2	5.1	B
	Subtotal	119	122	102.2%	15.5	2.6	B
WB	Left Turn	48	40	83.1%	16.0	6.4	B
	Through	17	14	82.7%	20.4	14.1	C
	Right Turn	28	25	89.6%	10.0	4.9	B
	Subtotal	93	79	85.0%	14.4	4.6	B
Total		2,204	2,107	95.6%	9.1	1.4	A

Intersection 31 Stockton Bl/Lemon Hill Av Signal

Direction	Movement	Demand Volume (vph)	Served Volume (vph)		Total Delay (sec/veh)		
			Average	Percent	Average	Std. Dev.	LOS
NB	Left Turn	25	22	89.7%	41.9	6.8	D
	Through	727	703	96.7%	20.1	3.2	C
	Right Turn	74	76	102.2%	5.9	1.4	A
	Subtotal	826	801	97.0%	19.3	3.0	B
SB	Left Turn	120	130	108.0%	38.6	6.2	D
	Through	1,061	1,063	100.2%	20.2	3.7	C
	Right Turn	57	47	82.0%	20.5	5.8	C
	Subtotal	1,238	1,239	100.1%	22.1	3.4	C
EB	Left Turn	64	56	87.9%	34.8	7.0	C
	Through	64	67	105.1%	32.0	9.6	C
	Right Turn	39	37	95.5%	11.7	5.1	B
	Subtotal	167	161	96.3%	29.1	3.7	C
WB	Left Turn	114	108	94.3%	32.6	7.8	C
	Through	123	119	96.4%	32.0	5.4	C
	Right Turn	107	106	99.4%	9.3	1.5	A
	Subtotal	344	333	96.7%	24.8	3.4	C
Total		2,575	2,533	98.4%	22.0	2.4	C

Intersection 32 Stockton Bl/Dias Av Signal

Direction	Movement	Demand Volume (vph)	Served Volume (vph)		Total Delay (sec/veh)		
			Average	Percent	Average	Std. Dev.	LOS
NB	Left Turn	40	39	96.9%	27.8	6.0	C
	Through	832	768	92.3%	7.2	1.4	A
	Right Turn	1	2	228.0%	1.6	2.3	A
	Subtotal	873	809	92.7%	8.2	1.6	A
SB	Left Turn	39	34	86.7%	16.0	5.7	B
	Through	1,202	1,172	97.5%	8.3	1.7	A
	Right Turn	38	38	100.0%	6.1	1.6	A
	Subtotal	1,279	1,244	97.3%	8.4	1.7	A
EB	Left Turn	6	5	76.0%	15.7	12.2	B
	Through	1	2	152.0%	10.3	17.2	B
	Right Turn	13	14	111.1%	11.8	7.0	B
	Subtotal	20	21	102.6%	15.0	7.4	B
WB	Left Turn	64	62	97.4%	14.7	4.9	B
	Through	2	2	76.0%	5.7	17.2	A
	Right Turn	29	33	112.7%	8.8	3.9	A
	Subtotal	95	97	101.6%	12.6	3.7	B
Total		2,267	2,170	95.7%	8.6	1.6	A

Intersection 33

Stockton Bl/47th Av-Elder Creek Rd

Signal

Direction	Movement	Demand Volume (vph)	Served Volume (vph)		Total Delay (sec/veh)		
			Average	Percent	Average	Std. Dev.	LOS
NB	Left Turn	214	203	94.6%	48.1	6.8	D
	Through	532	475	89.3%	34.6	3.1	C
	Right Turn	64	61	95.6%	6.7	1.2	A
	Subtotal	810	739	91.2%	36.0	1.5	D
SB	Left Turn	146	128	88.0%	54.2	6.5	D
	Through	830	765	92.1%	37.5	4.2	D
	Right Turn	316	309	97.6%	21.4	4.6	C
	Subtotal	1,292	1,202	93.0%	35.2	3.6	D
EB	Left Turn	241	261	108.2%	45.6	2.8	D
	Through	490	516	105.2%	31.9	2.9	C
	Right Turn	200	213	106.4%	26.3	4.1	C
	Subtotal	931	989	106.2%	34.3	2.1	C
WB	Left Turn	92	81	88.4%	97.1	23.9	F
	Through	803	778	96.9%	79.1	20.2	E
	Right Turn	116	98	84.8%	56.5	20.8	E
	Subtotal	1,011	958	94.8%	78.3	20.0	E
Total		4,044	3,887	96.1%	45.8	5.3	D

Intersection 34

Stockton Bl/Riza Av-Fowler Av

Signal

Direction	Movement	Demand Volume (vph)	Served Volume (vph)		Total Delay (sec/veh)		
			Average	Percent	Average	Std. Dev.	LOS
NB	Left Turn	30	33	108.9%	36.6	8.9	D
	Through	749	724	96.6%	12.8	2.7	B
	Right Turn	60	61	101.3%	11.2	2.5	B
	Subtotal	839	817	97.4%	13.6	2.9	B
SB	Left Turn	30	30	98.8%	46.0	10.6	D
	Through	1,025	994	97.0%	17.0	3.5	B
	Right Turn	27	25	91.8%	15.4	4.0	B
	Subtotal	1,082	1,049	96.9%	17.7	3.4	B
EB	Left Turn	17	14	80.5%	29.3	15.8	C
	Through	1	1	114.0%	27.8	15.7	C
	Right Turn	26	20	76.0%	10.9	7.1	B
	Subtotal	44	35	78.6%	17.2	5.8	B
WB	Left Turn	100	109	109.2%	30.9	5.0	C
	Through	3	3	85.5%	29.2	5.1	C
	Right Turn	31	34	109.1%	6.1	2.5	A
	Subtotal	134	146	108.6%	24.8	3.2	C
Total		2,099	2,046	97.5%	16.6	2.6	B

SimTraffic Post-Processor
Average Results from 10 Runs
Volume and Delay by Movement

Vision Zero Top 5 Corridors - Florin Rd
Existing Conditions
PM Peak Hour

Intersection 35 24th St/Florin Rd Signal

Direction	Movement	Demand Volume (vph)	Served Volume (vph)		Total Delay (sec/veh)		
			Average	Percent	Average	Std. Dev.	LOS
NB	Left Turn	131	120	92.0%	49.0	16.7	D
	Through	299	268	89.5%	27.5	3.1	C
	Right Turn	49	44	90.0%	20.4	4.9	C
	Subtotal	479	432	90.2%	33.0	4.9	C
SB	Left Turn	171	162	94.4%	49.9	5.9	D
	Through	487	506	103.9%	28.4	2.1	C
	Right Turn	400	399	99.8%	18.3	3.6	B
	Subtotal	1,058	1,067	100.9%	27.9	1.7	C
EB	Left Turn	241	242	100.3%	55.0	9.8	E
	Through	652	654	100.4%	28.6	2.5	C
	Right Turn	89	84	94.8%	23.6	3.6	C
	Subtotal	982	980	99.8%	34.8	2.5	C
WB	Left Turn	112	106	95.0%	61.0	5.6	E
	Through	719	681	94.7%	26.8	2.4	C
	Right Turn	139	138	99.2%	13.2	1.6	B
	Subtotal	970	925	95.4%	28.7	2.4	C
Total		3,489	3,404	97.6%	30.8	1.1	C

Intersection 36 Woodbine Av/Florin Rd Signal

Direction	Movement	Demand Volume (vph)	Served Volume (vph)		Total Delay (sec/veh)		
			Average	Percent	Average	Std. Dev.	LOS
NB	Left Turn	2	0	19.0%	7.6	24.0	A
	Through						
	Right Turn	1	1	76.0%	1.2	2.7	A
	Subtotal	3	1	38.0%	8.8	23.8	A
SB	Left Turn	36	32	89.7%	41.5	7.5	D
	Through						
	Right Turn	34	33	96.1%	11.4	4.5	B
	Subtotal	70	65	92.8%	26.6	4.5	C
EB	Left Turn	54	51	94.3%	49.3	10.6	D
	Through	966	948	98.2%	12.4	2.0	B
	Right Turn	2	2	95.0%	4.9	2.3	A
	Subtotal	1,022	1,001	98.0%	14.2	1.9	B
WB	Left Turn	5	5	106.4%	55.5	22.0	E
	Through	1,085	1,041	96.0%	7.0	1.3	A
	Right Turn	31	30	96.8%	6.0	2.4	A
	Subtotal	1,121	1,077	96.0%	7.2	1.2	A
Total		2,216	2,144	96.7%	11.0	1.2	B

SimTraffic Post-Processor
Average Results from 10 Runs
Volume and Delay by Movement

Vision Zero Top 5 Corridors - Florin Rd
Existing Conditions
PM Peak Hour

Intersection 37 Indian Ln-29th St/Florin Rd Signal

Direction	Movement	Demand Volume (vph)	Served Volume (vph)		Total Delay (sec/veh)		
			Average	Percent	Average	Std. Dev.	LOS
NB	Left Turn	54	54	99.2%	39.3	5.5	D
	Through	19	17	88.0%	36.8	11.2	D
	Right Turn	146	141	96.6%	11.2	1.5	B
	Subtotal	219	211	96.5%	20.4	3.0	C
SB	Left Turn	70	67	95.0%	40.2	6.4	D
	Through	11	9	82.9%	38.2	20.1	D
	Right Turn	32	41	129.4%	9.2	5.0	A
	Subtotal	113	117	103.6%	29.6	5.0	C
EB	Left Turn	37	38	101.7%	49.5	7.2	D
	Through	961	950	98.9%	21.7	3.3	C
	Right Turn	33	32	95.6%	18.9	5.6	B
	Subtotal	1,031	1,019	98.9%	22.6	3.3	C
WB	Left Turn	190	171	90.2%	53.3	9.0	D
	Through	1,094	1,053	96.2%	12.5	3.2	B
	Right Turn	79	82	103.9%	4.5	0.9	A
	Subtotal	1,363	1,306	95.8%	17.5	2.6	B
Total		2,726	2,654	97.3%	20.2	1.7	C

Intersection 39 Hisperry Ln-Luther Burbank HS/Florin Rd Signal

Direction	Movement	Demand Volume (vph)	Served Volume (vph)		Total Delay (sec/veh)		
			Average	Percent	Average	Std. Dev.	LOS
NB	Left Turn	15	16	103.9%	59.6	11.7	E
	Through						
	Right Turn	11	11	100.2%	13.0	7.7	B
	Subtotal	26	27	102.3%	39.1	9.2	D
SB	Left Turn						
	Through						
	Right Turn	2	2	76.0%	2.9	6.3	A
	Subtotal	2	2	76.0%	2.9	6.3	A
EB	Left Turn						
	Through	1,135	1,097	96.6%	1.8	0.3	A
	Right Turn	2	2	114.0%	0.6	1.2	A
	Subtotal	1,137	1,099	96.7%	1.8	0.3	A
WB	Left Turn	12	9	76.0%	51.6	32.1	D
	Through	1,354	1,306	96.5%	4.8	0.9	A
	Right Turn	8	7	90.3%	3.4	3.5	A
	Subtotal	1,374	1,323	96.3%	5.1	0.8	A
Total		2,539	2,450	96.5%	4.0	0.5	A

SimTraffic Post-Processor
Average Results from 10 Runs
Volume and Delay by Movement

Vision Zero Top 5 Corridors - Florin Rd
Existing Conditions
PM Peak Hour

Intersection 40 **Luther Dr/Florin Rd** **Signal**

Direction	Movement	Demand Volume (vph)	Served Volume (vph)		Total Delay (sec/veh)		
			Average	Percent	Average	Std. Dev.	LOS
NB	Left Turn	105	98	93.2%	39.8	4.7	D
	Through	5	4	87.4%	37.6	4.5	D
	Right Turn	48	51	105.3%	13.4	4.8	B
	Subtotal	158	153	96.7%	31.0	4.2	C
SB	Left Turn	83	83	99.6%	37.9	5.4	D
	Through	8	7	92.6%	37.8	5.5	D
	Right Turn	184	185	100.4%	15.2	3.7	B
	Subtotal	275	275	99.9%	22.7	3.7	C
EB	Left Turn	127	117	91.9%	55.3	8.2	E
	Through	929	885	95.3%	58.1	8.6	E
	Right Turn	84	84	100.2%	58.0	9.0	E
	Subtotal	1,140	1,086	95.3%	57.8	8.6	E
WB	Left Turn	57	55	99.5%	63.2	11.3	E
	Through	1,080	1,050	97.2%	34.0	3.8	C
	Right Turn	48	47	97.0%	31.8	3.8	C
	Subtotal	1,185	1,151	97.1%	35.3	4.0	D
Total		2,758	2,665	96.6%	42.9	3.5	D

Intersection 41 **Munson Wy/Florin Rd** **Signal**

Direction	Movement	Demand Volume (vph)	Served Volume (vph)		Total Delay (sec/veh)		
			Average	Percent	Average	Std. Dev.	LOS
NB	Left Turn						
	Through						
	Right Turn	42	38	91.4%	6.9	2.7	A
	Subtotal	42	38	91.4%	6.9	2.7	A
SB	Left Turn	1	1	114.0%	20.7	15.8	C
	Through						
	Right Turn	5	4	76.0%	7.7	8.4	A
	Subtotal	6	5	82.3%	8.6	9.6	A
EB	Left Turn	9	9	97.1%	13.6	11.2	B
	Through	1,006	968	96.2%	2.6	0.6	A
	Right Turn	66	51	77.7%	2.3	0.6	A
	Subtotal	1,081	1,028	95.1%	2.7	0.6	A
WB	Left Turn	169	157	92.9%	13.9	2.7	B
	Through	1,176	1,167	99.2%	1.2	0.3	A
	Right Turn	9	8	84.4%	0.1	0.2	A
	Subtotal	1,354	1,332	98.3%	2.7	0.7	A
Total		2,483	2,403	96.8%	2.8	0.6	A

StreetScore+ Results

Existing Conditions



Intro Card

Input For General Roadway Characteristics		Dir1 - SB	Dir2 - NB
Roadway Variables		Marysville BI	Marysville BI
Roadway Name		Doolittle St and North Av	Doolittle St and North Av
Roadway Extents		> 15000	> 15000
ADT (average daily traffic)		45	45
Prevailing Speed in MPH (use posted speed limit if speed data is not available)		No	No
Are the bicycle conditions the same in both directions? (e.g. bicycle facilities are the same in both directions, number of lanes are the same in both directions)		No	No
Are the pedestrian conditions the same in both directions? (e.g. sidewalk of similar width present on both sides of the street, number of lanes are the same in both directions)		No	No
Is there a raised median?		No	No
Number of Total Travel Lanes		5	5

StreetScore+

Bike Score
by Link

Refer to StreetScore+ white paper for criteria definitions.

Bike StreetScore by Link		Dir1 - SB Input	Dir 2 - NB Input
View Basic Roadway Characteristics?			
What is the bicycle facility type?		Bicycle Lane	Bicycle Lane
Speed		45	45
# of Travel Lanes		5	5
Is the bikeway frequently blocked?		No	No
Is there on-street parking?		No	No
What is the bicycle lane width?		5'	5.5'
Is there a raised median present?		No	No
Segment LTS Score Per Mineta Methodology		4	4
Street Score+ LTS Score		4	4

StreetScore+

Pedestrian Score by Link

Refer to StreetScore+ white paper for criteria definitions.

	Dir1 - SB Input	Dir2 - NB Input
Pedestrian Streetscore by Link		
View Basic Roadway Characteristics?	-	
What is the width of the sidewalk?	<6'	7-6'
Is the sidewalk in good repair?	Even, Smooth Surface Frequent Driveway Curb Cuts into the Sidewalk Zone No Landscaping	Even, Smooth Surface Frequent Driveway Curb Cuts into the Sidewalk Zone No Landscaping
Does the sidewalk provide a continuous pedestrian environment?	45	45
Is there a landscape buffer and street trees?	5	5
What is the prevailing speed? Number of Travel Lanes? Is lighting present?	Roadway Lighting Only	Roadway Lighting Only
What is the percent of heavy vehicles in curbside travel lane? (Use total percentage if by-lane data is not available. Percentage should not include transit vehicles.)	<=5%	<=5%
(Optional) What is the crosswalk frequency?	Crosswalks Spaced > 400'	Crosswalks Spaced > 400'
Street Score+ LTS Score	4	4



Intro Card

Input For General Roadway Characteristics		Dir1 - SB	Dir2 - NB
Roadway Variables		Marysville BI	Marysville BI
Roadway Name		North Av and Harris Av	North Av and Harris Av
Roadway Extents		> 15000	> 15000
ADT (average daily traffic)		35	35
Prevailing Speed in MPH (use posted speed limit if speed data is not available)		No	No
Are the bicycle conditions the same in both directions? (e.g. bicycle facilities are the same in both directions, number of lanes are the same in both directions)		No	No
Are the pedestrian conditions the same in both directions? (e.g. sidewalk of similar width present on both sides of the street, number of lanes are the same in both directions)		Yes	Yes
Is there a raised median?		4	4
Number of Total Travel Lanes			

StreetScore+

Bike Score
by Link

Refer to StreetScore+ white paper for criteria definitions.

Bike StreetScore by Link		Dir1 - SB Input	Dir 2 - NB Input
View Basic Roadway Characteristics?			
What is the bicycle facility type?		Bicycle Lane	Bicycle Lane
Speed		35	35
# of Travel Lanes		4	4
Is the bikeway frequently blocked?		No	No
Is there on-street parking?		No	No
What is the bicycle lane width?		<5'	5'
Is there a raised median present?		Yes	Yes
Segment LTS Score Per Mineta Methodology		3	3
Street Score+ LTS Score		3	3

StreetScore+

Pedestrian Score by Link

Refer to StreetScore+ white paper for criteria definitions.

	Dir1 - SB Input	Dir2 - NB Input
Pedestrian Streetscore by Link	-	-
View Basic Roadway Characteristics?		
What is the width of the sidewalk?	<6' Even, Smooth Surface	7-6' Even, Smooth Surface
Is the sidewalk in good repair?	Frequent Driveway Curb Cuts into the Sidewalk Zone	Frequent Driveway Curb Cuts into the Sidewalk Zone
Does the sidewalk provide a continuous pedestrian environment?	No Landscaping	No Landscaping
Is there a landscape buffer and street trees?	35	35
What is the prevailing speed?	4	4
Number of Travel Lanes?	Roadway Lighting Only	Roadway Lighting Only
Is lighting present?	<=5%	<=5%
What is the percent of heavy vehicles in curbside travel lane? (Use total percentage if by-lane data is not available. Percentage should not include transit vehicles.)	Crosswalks Spaced > 400'	Crosswalks Spaced > 400'
(Optional) What is the crosswalk frequency?	3	3
Street Score+ LTS Score	3	3



Intro Card

Input For General Roadway Characteristics		Dir1 - SB	Dir2 - NB
Roadway Variables		Dir1 - SB	Dir2 - NB
Roadway Name		Marysville BI	Marysville BI
Roadway Extents		Harris Av to Grand Av	Harris Av to Grand Av
ADT (average daily traffic)		> 15000	> 15000
Prevailing Speed in MPH (use posted speed limit if speed data is not available)		35	35
Are the bicycle conditions the same in both directions? (e.g. bicycle facilities are the same in both directions, number of lanes are the same in both directions)		No	No
Are the pedestrian conditions the same in both directions? (e.g. sidewalk of similar width present on both sides of the street, number of lanes are the same in both directions)		No	No
Is there a raised median?		Yes	Yes
Number of Total Travel Lanes		4	4

StreetScore+

Bike Score
by Link

Refer to StreetScore+ white paper for criteria definitions.

Bike StreetScore by Link		Dir1 - SB Input	Dir 2 - NB Input
View Basic Roadway Characteristics?			
What is the bicycle facility type?		Bicycle Lane	Bicycle Lane
Speed		35	35
# of Travel Lanes		4	4
Is the bikeway frequently blocked?		No	No
Is there on-street parking?		No	No
What is the bicycle lane width?		5'	5.5'
Is there a raised median present?		Yes	Yes
Segment LTS Score Per Mineta Methodology		3	3
Street Score+ LTS Score		3	3

StreetScore+

Pedestrian Score by Link

Refer to StreetScore+ white paper for criteria definitions.

Pedestrian Streetscore by Link		Dir1 - SB Input	Dir2 - NB Input
View Basic Roadway Characteristics?		-	
What is the width of the sidewalk?		<6'	<6'
Is the sidewalk in good repair?		Even, Smooth Surface	Even, Smooth Surface
Does the sidewalk provide a continuous pedestrian environment?		Frequent Driveway Curb Cuts into the Sidewalk Zone	Frequent Driveway Curb Cuts into the Sidewalk Zone
Is there a landscape buffer and street trees?		No Landscaping	No Landscaping
What is the prevailing speed?		35	35
Number of Travel Lanes?		4	4
Is lighting present?		Roadway Lighting Only	Roadway Lighting Only
What is the percent of heavy vehicles in curbside travel lane? (Use total percentage if by-lane data is not available. Percentage should not include transit vehicles.)		<=5%	<=5%
(Optional) What is the crosswalk frequency?		Crosswalks Spaced > 400'	Crosswalks Spaced > 400'
Street Score+ LTS Score		3	3



Intro Card

Input For General Roadway Characteristics		Dir1 - SB	Dir2 - NB
Roadway Variables		Marysville BI	Marysville BI
Roadway Name		Grand Av to Roanoke Av	Grand Av to Roanoke Av
Roadway Extents		> 15000	> 15000
ADT (average daily traffic)		35	35
Prevailing Speed in MPH (use posted speed limit if speed data is not available)		No	No
Are the bicycle conditions the same in both directions? (e.g. bicycle facilities are the same in both directions, number of lanes are the same in both directions)		No	No
Are the pedestrian conditions the same in both directions? (e.g. sidewalk of similar width present on both sides of the street, number of lanes are the same in both directions)		Yes	Yes
Is there a raised median?		4	4
Number of Total Travel Lanes			

StreetScore+

Bike Score by Link

Refer to StreetScore+ white paper for criteria definitions.

Bike StreetScore by Link		Dir1 - SB Input	Dir 2 - NB Input
View Basic Roadway Characteristics?			
What is the bicycle facility type?		Bicycle Lane	Bicycle Lane
Speed		35	35
# of Travel Lanes		4	4
Is the bikeway frequently blocked?		No	No
Is there on-street parking?		Yes	Yes
What is the combined bicycle lane and parking lane width?		<13'	<13'
Segment LTS Score Per Mineta Methodology		3	3
Street Score+ LTS Score		3	3

StreetScore+

Pedestrian Score by Link

Refer to StreetScore+ white paper for criteria definitions.

Pedestrian Streetscore by Link		Dir1 - SB Input	Dir2 - NB Input
View Basic Roadway Characteristics?		-	
What is the width of the sidewalk?		<6'	<6'
Is the sidewalk in good repair?		Even, Smooth Surface	Even, Smooth Surface
Does the sidewalk provide a continuous pedestrian environment?		Frequent Driveway Curb Cuts into the Sidewalk Zone	Frequent Driveway Curb Cuts into the Sidewalk Zone
Is there a landscape buffer and street trees?		No Landscaping	No Landscaping
What is the prevailing speed?		35	35
Number of Travel Lanes?		4	4
Is lighting present?		Roadway Lighting Only	Roadway Lighting Only
What is the percent of heavy vehicles in curbside travel lane? (Use total percentage if by-lane data is not available. Percentage should not include transit vehicles.)		<=5%	<=5%
(Optional) What is the crosswalk frequency?		Crosswalks Spaced > 400'	Crosswalks Spaced > 400'
Street Score+ LTS Score		3	3



Intro Card

Input For General Roadway Characteristics		Dir1 - SB	Dir2 - NB
Roadway Variables		Marysville BI	Marysville BI
Roadway Name		Roanoke Av to South Av	Roanoke Av to South Av
Roadway Extents		> 15000	> 15000
ADT (average daily traffic)		35	35
Prevailing Speed in MPH (use posted speed limit if speed data is not available)		No	No
Are the bicycle conditions the same in both directions? (e.g. bicycle facilities are the same in both directions, number of lanes are the same in both directions)		No	No
Are the pedestrian conditions the same in both directions? (e.g. sidewalk of similar width present on both sides of the street, number of lanes are the same in both directions)		Yes	Yes
Is there a raised median?		4	4
Number of Total Travel Lanes			

StreetScore+

Bike Score
by Link

Refer to StreetScore+ white paper for criteria definitions.

Bike StreetScore by Link		Dir1 - SB Input	Dir 2 - NB Input
View Basic Roadway Characteristics?			
What is the bicycle facility type?		Bicycle Lane	Bicycle Lane
Speed		35	35
# of Travel Lanes		4	4
Is the bikeway frequently blocked?		No	No
Is there on-street parking?		No	No
What is the bicycle lane width?		6'	<5'
Is there a raised median present?		Yes	Yes
Segment LTS Score Per Mineta Methodology		3	3
Street Score+ LTS Score		3	3

StreetScore+

Pedestrian
Score by
Link

Refer to StreetScore+ white paper for criteria definitions.

Pedestrian Streetscore by Link		Dir1 - SB Input	Dir2 - NB Input
View Basic Roadway Characteristics?		-	
What is the width of the sidewalk?		7-6'	7-6'
Is the sidewalk in good repair?		Even, Smooth Surface	Even, Smooth Surface
Does the sidewalk provide a continuous pedestrian environment?		Frequent Driveway Curb Cuts into the Sidewalk Zone No Landscaping	Frequent Driveway Curb Cuts into the Sidewalk Zone No Landscaping
Is there a landscape buffer and street trees?		35	35
What is the prevailing speed? Number of Travel Lanes?		4	4
Is lighting present?		Roadway Lighting Only	Roadway Lighting Only
What is the percent of heavy vehicles in curbside travel lane? (Use total percentage if by-lane data is not available. Percentage should not include transit vehicles.)		< =5%	< =5%
(Optional) What is the crosswalk frequency?		Crosswalks Spaced > 400'	Crosswalks Spaced > 400'
Street Score+ LTS Score		3	3



Intro Card

Input For General Roadway Characteristics		Dir1 - SB	Dir2 - NB
Roadway Variables		Dir1 - SB	Dir2 - NB
Roadway Name		Marysville BI	Marysville BI
Roadway Extents		South Av to Nogales St	South Av to Nogales St
ADT (average daily traffic)		> 15000	> 15000
Prevailing Speed in MPH (use posted speed limit if speed data is not available)		35	35
Are the bicycle conditions the same in both directions? (e.g. bicycle facilities are the same in both directions, number of lanes are the same in both directions)		No	No
Are the pedestrian conditions the same in both directions? (e.g. sidewalk of similar width present on both sides of the street, number of lanes are the same in both directions)		No	No
Is there a raised median?		Yes	Yes
Number of Total Travel Lanes		5	5

StreetScore+

Bike Score
by Link

Refer to StreetScore+ white paper for criteria definitions.

Bike StreetScore by Link		Dir1 - SB Input	Dir 2 - NB Input
View Basic Roadway Characteristics?			
What is the bicycle facility type?		Bicycle Lane	Bicycle Lane
Speed		35	35
# of Travel Lanes		5	5
Is the bikeway frequently blocked?		No	No
Is there on-street parking?		No	No
What is the bicycle lane width?		5'	<5'
Is there a raised median present?		Yes	Yes
Segment LTS Score Per Mineta Methodology		3	3
Street Score+ LTS Score		3	3

StreetScore+

Pedestrian Score by Link

Refer to StreetScore+ white paper for criteria definitions.

Pedestrian Streetscore by Link		Dir1 - SB Input	Dir2 - NB Input
View Basic Roadway Characteristics?		-	
What is the width of the sidewalk?		<6'	7-6'
Is the sidewalk in good repair?		Even, Smooth Surface	Even, Smooth Surface
Does the sidewalk provide a continuous pedestrian environment?		Frequent Driveway Curb Cuts into the Sidewalk Zone	Driveway Curb Cuts Out of the Sidewalk Zone
Is there a landscape buffer and street trees?		No Landscaping	No Landscaping
What is the prevailing speed?		35	35
Number of Travel Lanes?		5	5
Is lighting present?		Roadway Lighting Only	Roadway Lighting Only
What is the percent of heavy vehicles in curbside travel lane? (Use total percentage if by-lane data is not available. Percentage should not include transit vehicles.)		< =5%	< =5%
(Optional) What is the crosswalk frequency?		Crosswalks Spaced > 400'	Crosswalks Spaced > 400'
Street Score+ LTS Score		3	3



Intro Card

Input For General Roadway Characteristics		Dir1 - SB	Dir2 - NB
Roadway Variables		Marysville BI	Marysville BI
Roadway Name		Nogales St to Rosalind St	Nogales St to Rosalind St
Roadway Extents		> 15000	> 15000
ADT (average daily traffic)		35	35
Prevailing Speed in MPH (use posted speed limit if speed data is not available)		No	No
Are the bicycle conditions the same in both directions? (e.g. bicycle facilities are the same in both directions, number of lanes are the same in both directions)		No	No
Are the pedestrian conditions the same in both directions? (e.g. sidewalk of similar width present on both sides of the street, number of lanes are the same in both directions)		No	No
Is there a raised median?		No	No
Number of Total Travel Lanes		5	5

StreetScore+

Bike Score
by Link

Refer to StreetScore+ white paper for criteria definitions.

Bike StreetScore by Link		Dir1 - SB Input	Dir 2 - NB Input
View Basic Roadway Characteristics?			
What is the bicycle facility type?		Bicycle Lane	Bicycle Lane
Speed		35	35
# of Travel Lanes		5	5
Is the bikeway frequently blocked?		No	No
Is there on-street parking?		No	No
What is the bicycle lane width?		5.5'	<5'
Is there a raised median present?		No	No
Segment LTS Score Per Mineta Methodology		3	3
Street Score+ LTS Score		3	3

StreetScore+

Pedestrian
Score by
Link

Refer to StreetScore+ white paper for criteria definitions.

	Dir1 - SB Input	Dir2 - NB Input
Pedestrian Streetscore by Link		
View Basic Roadway Characteristics?	-	-
What is the width of the sidewalk?	<6'	7-6'
Is the sidewalk in good repair?	Even, Smooth Surface	Even, Smooth Surface
Does the sidewalk provide a continuous pedestrian environment?	Driveway Curb Cuts Out of the Sidewalk Zone	Driveway Curb Cuts Out of the Sidewalk Zone
Is there a landscape buffer and street trees?	No Landscaping	No Landscaping
What is the prevailing speed?	35	35
Number of Travel Lanes?	5	5
Is lighting present?	Roadway Lighting Only	Roadway Lighting Only
What is the percent of heavy vehicles in curbside travel lane? (Use total percentage if by-lane data is not available. Percentage should not include transit vehicles.)	<=5%	<=5%
(Optional) What is the crosswalk frequency?	Crosswalks Spaced > 400'	Crosswalks Spaced > 400'
Street Score+ LTS Score	3	3



Intro Card

Input For General Roadway Characteristics		Dir1 - SB	Dir2 - NB
Roadway Variables		Marysville BI	Marysville BI
Roadway Name		Rosalind St to Los Robles BI N	Rosalind St to Los Robles BI N
Roadway Extents		> 15000	> 15000
ADT (average daily traffic)		35	35
Prevailing Speed in MPH (use posted speed limit if speed data is not available)		No	No
Are the bicycle conditions the same in both directions? (e.g. bicycle facilities are the same in both directions, number of lanes are the same in both directions)		No	No
Are the pedestrian conditions the same in both directions? (e.g. sidewalk of similar width present on both sides of the street, number of lanes are the same in both directions)		No	No
Is there a raised median?		No	No
Number of Total Travel Lanes		5	5

StreetScore+

Bike Score
by Link

Refer to StreetScore+ white paper for criteria definitions.

Bike StreetScore by Link		Dir1 - SB Input	Dir 2 - NB Input
View Basic Roadway Characteristics?			
What is the bicycle facility type?		Bicycle Lane	Bicycle Lane
Speed		35	35
# of Travel Lanes		5	5
Is the bikeway frequently blocked?		No	No
Is there on-street parking?		No	No
What is the bicycle lane width?		5'	<5'
Is there a raised median present?		No	No
Segment LTS Score Per Mineta Methodology		3	3
Street Score+ LTS Score		3	3

StreetScore+

Pedestrian Score by Link

Refer to StreetScore+ white paper for criteria definitions.

Pedestrian Streetscore by Link		Dir1 - SB Input	Dir2 - NB Input
View Basic Roadway Characteristics?			
What is the width of the sidewalk?		<6'	7-6'
Is the sidewalk in good repair?		Even, Smooth Surface	Even, Smooth Surface
Does the sidewalk provide a continuous pedestrian environment?		Frequent Driveway Curb Cuts into the Sidewalk Zone	Frequent Driveway Curb Cuts into the Sidewalk Zone
Is there a landscape buffer and street trees?		No Landscaping	No Landscaping
What is the prevailing speed?		35	35
Number of Travel Lanes?		5	5
Is lighting present?		Roadway Lighting Only	No Lighting
What is the percent of heavy vehicles in curbside travel lane? (Use total percentage if by-lane data is not available. Percentage should not include transit vehicles.)		< =5%	< =5%
(Optional) What is the crosswalk frequency?		Crosswalks Spaced > 400'	Crosswalks Spaced > 400'
Street Score+ LTS Score		3	4



Intro Card

Input For General Roadway Characteristics		Dir1 - SB	Dir2 - NB
Roadway Variables		Marysville BI	Marysville BI
Roadway Name		Los Robles BI N to Los Robles BI S	Los Robles BI N to Los Robles BI S
Roadway Extents		> 15000	> 15000
ADT (average daily traffic)		35	35
Prevailing Speed in MPH (use posted speed limit if speed data is not available)		No	No
Are the bicycle conditions the same in both directions? (e.g. bicycle facilities are the same in both directions, number of lanes are the same in both directions)		No	No
Are the pedestrian conditions the same in both directions? (e.g. sidewalk of similar width present on both sides of the street, number of lanes are the same in both directions)		No	No
Is there a raised median?		No	No
Number of Total Travel Lanes		5	5

StreetScore+

Bike Score
by Link

Refer to StreetScore+ white paper for criteria definitions.

Bike StreetScore by Link		Dir1 - SB Input	Dir 2 - NB Input
View Basic Roadway Characteristics?			
What is the bicycle facility type?		Bicycle Lane	Bicycle Lane
Speed		35	35
# of Travel Lanes		5	5
Is the bikeway frequently blocked?		No	No
Is there on-street parking?		No	No
What is the bicycle lane width?		5'	5.5'
Is there a raised median present?		No	No
Segment LTS Score Per Mineta Methodology		3	3
Street Score+ LTS Score		3	3

StreetScore+

Pedestrian Score by Link

Refer to StreetScore+ white paper for criteria definitions.

Pedestrian Streetscore by Link		Dir1 - SB Input	Dir2 - NB Input
View Basic Roadway Characteristics?		-	
What is the width of the sidewalk?		<6'	<6'
Is the sidewalk in good repair?		Even, Smooth Surface	Even, Smooth Surface
Does the sidewalk provide a continuous pedestrian environment?		Frequent Driveway Curb Cuts into the Sidewalk Zone	Frequent Driveway Curb Cuts into the Sidewalk Zone
Is there a landscape buffer and street trees?		No Landscaping	No Landscaping
What is the prevailing speed?		35	35
Number of Travel Lanes?		5	5
Is lighting present?		Roadway Lighting Only	Roadway Lighting Only
What is the percent of heavy vehicles in curbside travel lane? (Use total percentage if by-lane data is not available. Percentage should not include transit vehicles.)		<=5%	<=5%
(Optional) What is the crosswalk frequency?		Crosswalks Spaced > 400'	Crosswalks Spaced > 400'
Street Score+ LTS Score		3	3



Intro Card

Input For General Roadway Characteristics		Dir1 - SB	Dir2 - NB
Roadway Variables		Marysville BI	Marysville BI
Roadway Name		Los Robles BI S to Ermina Dr	Los Robles BI S to Ermina Dr
Roadway Extents		> 15000	> 15000
ADT (average daily traffic)		35	35
Prevailing Speed in MPH (use posted speed limit if speed data is not available)		No	No
Are the bicycle conditions the same in both directions? (e.g. bicycle facilities are the same in both directions, number of lanes are the same in both directions)		No	No
Are the pedestrian conditions the same in both directions? (e.g. sidewalk of similar width present on both sides of the street, number of lanes are the same in both directions)		No	No
Is there a raised median?		5	5
Number of Total Travel Lanes			

StreetScore+

Bike Score
by Link

Refer to StreetScore+ white paper for criteria definitions.

Bike StreetScore by Link		Dir1 - SB Input	Dir 2 - NB Input
View Basic Roadway Characteristics?			
What is the bicycle facility type?		Bicycle Route Or No Designated Bikeway	Bicycle Route Or No Designated Bikeway
Speed		35	35
# of Travel Lanes		5	5
Does the street have a centerline?		Yes	Yes
Is the street classified as residential?		No	No
Segment LTS Score Per Mineta Methodology		4	4
Street Score+ LTS Score		4	4

StreetScore+

Pedestrian Score by Link

Refer to StreetScore+ white paper for criteria definitions.

Pedestrian Streetscore by Link		Dir1 - SB Input	Dir2 - NB Input
View Basic Roadway Characteristics?			
What is the width of the sidewalk?		<6'	<6'
Is the sidewalk in good repair?		Even, Smooth Surface	Even, Smooth Surface
Does the sidewalk provide a continuous pedestrian environment?		Frequent Driveway Curb Cuts into the Sidewalk Zone	Frequent Driveway Curb Cuts into the Sidewalk Zone
Is there a landscape buffer and street trees?		No Landscaping	No Landscaping
What is the prevailing speed?		35	35
Number of Travel Lanes?		5	5
Is lighting present?		Roadway Lighting Only	Roadway Lighting Only
What is the percent of heavy vehicles in curbside travel lane? (Use total percentage if by-lane data is not available. Percentage should not include transit vehicles.)		<=5%	<=5%
(Optional) What is the crosswalk frequency?		Crosswalks Spaced > 400'	Crosswalks Spaced > 400'
Street Score+ LTS Score		3	3



Intro Card

Input For General Roadway Characteristics		Dir1 - SB	Dir2 - NB
Roadway Variables		Marysville BI	Marysville BI
Roadway Name		Los Robles BI S to Arcade BI	Los Robles BI S to Arcade BI
Roadway Extents		> 15000	> 15000
ADT (average daily traffic)		35	35
Prevailing Speed in MPH (use posted speed limit if speed data is not available)		No	No
Are the bicycle conditions the same in both directions? (e.g. bicycle facilities are the same in both directions, number of lanes are the same in both directions)		No	No
Are the pedestrian conditions the same in both directions? (e.g. sidewalk of similar width present on both sides of the street, number of lanes are the same in both directions)		No	No
Is there a raised median?		No	No
Number of Total Travel Lanes		5	5



Bike Score
by Link

Refer to StreetScore+ white paper for criteria definitions.

Bike StreetScore by Link		Dir1 - SB Input	Dir 2 - NB Input
View Basic Roadway Characteristics?			
What is the bicycle facility type?		Bicycle Route Or No Designated Bikeway	Bicycle Route Or No Designated Bikeway
Speed		35	35
# of Travel Lanes		5	5
Does the street have a centerline?		Yes	Yes
Is the street classified as residential?		No	No
Segment LTS Score Per Mineta Methodology		4	4
Street Score+ LTS Score		4	4

StreetScore+

Pedestrian Score by Link

Refer to StreetScore+ white paper for criteria definitions.

Pedestrian Streetscore by Link		Dir1 - SB Input	Dir2 - NB Input
View Basic Roadway Characteristics?		-	
What is the width of the sidewalk?		7-6'	<6'
Is the sidewalk in good repair?		Even, Smooth Surface	Even, Smooth Surface
Does the sidewalk provide a continuous pedestrian environment?		Frequent Driveway Curb Cuts into the Sidewalk Zone	Frequent Driveway Curb Cuts into the Sidewalk Zone
Is there a landscape buffer and street trees?		No Landscaping	No Landscaping
What is the prevailing speed?		35	35
Number of Travel Lanes?		5	5
Is lighting present?		Roadway Lighting Only	No Lighting
What is the percent of heavy vehicles in curbside travel lane? (Use total percentage if by-lane data is not available. Percentage should not include transit vehicles.)		< =5%	< =5%
(Optional) What is the crosswalk frequency?		Crosswalks Spaced > 400'	Crosswalks Spaced > 400'
Street Score+ LTS Score		3	4



Intro Card

Input For General Roadway Characteristics		Dir1 - SB	Dir2 - NB
Roadway Variables		Marysville BI	Marysville BI
Roadway Name		Arcade BI to Sonoma	Arcade BI to Sonoma
Roadway Extents		Av	Av
ADT (average daily traffic)		> 15000	> 15000
Prevailing Speed in MPH (use posted speed limit if speed data is not available)		35	35
Are the bicycle conditions the same in both directions? (e.g. bicycle facilities are the same in both directions, number of lanes are the same in both directions)		No	No
Are the pedestrian conditions the same in both directions? (e.g. sidewalk of similar width present on both sides of the street, number of lanes are the same in both directions)		No	No
Is there a raised median?		No	No
Number of Total Travel Lanes		4	4

StreetScore+

Bike Score
by Link

Refer to StreetScore+ white paper for criteria definitions.

Bike StreetScore by Link		Dir1 - SB Input	Dir 2 - NB Input
View Basic Roadway Characteristics?			
What is the bicycle facility type?		Bicycle Route Or No Designated Bikeway	Bicycle Route Or No Designated Bikeway
Speed		35	35
# of Travel Lanes		4	4
Does the street have a centerline?		Yes	Yes
Is the street classified as residential?		No	No
Segment LTS Score Per Mineta Methodology		4	4
Street Score+ LTS Score		4	4

StreetScore+

Pedestrian Score by Link

Refer to StreetScore+ white paper for criteria definitions.

Pedestrian Streetscore by Link		Dir1 - SB Input	Dir2 - NB Input
View Basic Roadway Characteristics?			
What is the width of the sidewalk?		<6'	<6'
Is the sidewalk in good repair?		Even, Smooth Surface	Even, Smooth Surface
Does the sidewalk provide a continuous pedestrian environment?		Frequent Driveway Curb Cuts into the Sidewalk Zone	Frequent Driveway Curb Cuts into the Sidewalk Zone
Is there a landscape buffer and street trees?		No Landscaping	No Landscaping
What is the prevailing speed?		35	35
Number of Travel Lanes?		4	4
Is lighting present?		No Lighting	Roadway Lighting Only
What is the percent of heavy vehicles in curbside travel lane? (Use total percentage if by-lane data is not available. Percentage should not include transit vehicles.)		<=5%	<=5%
(Optional) What is the crosswalk frequency?		Crosswalks Spaced > 400'	Crosswalks Spaced > 400'
Street Score+ LTS Score		4	3



Intro Card

Input For General Roadway Characteristics		Dir1 - WB	Dir2 - EB
Roadway Variables		El Camino Av	El Camino Av
Roadway Name		Rail Crossing to Western Av	Rail Crossing to Western Av
Roadway Extents		12001-15000	12001-15000
ADT (average daily traffic)		30	30
Prevailing Speed in MPH (use posted speed limit if speed data is not available)		No	No
Are the bicycle conditions the same in both directions? (e.g. bicycle facilities are the same in both directions, number of lanes are the same in both directions)		No	No
Are the pedestrian conditions the same in both directions? (e.g. sidewalk of similar width present on both sides of the street, number of lanes are the same in both directions)		No	No
Is there a raised median?		No	No
Number of Total Travel Lanes		2	2

StreetScore+

Bike Score
by Link

Refer to StreetScore+ white paper for criteria definitions.

Bike StreetScore by Link		Dir1 - WB Input	Dir 2 - EB Input
View Basic Roadway Characteristics?			
What is the bicycle facility type?		Bicycle Lane	Bicycle Lane
Speed		30	30
# of Travel Lanes		2	2
Is the bikeway frequently blocked?		No	No
Is there on-street parking?		No	No
What is the bicycle lane width?		> =7'	6'
Is there a raised median present?		No	No
Segment LTS Score Per Mineta Methodology		3	3
Street Score+ LTS Score		3	3

StreetScore+

Pedestrian Score by Link

Refer to StreetScore+ white paper for criteria definitions.

Pedestrian Streetscore by Link		Dir1 - WB Input	Dir2 - EB Input
View Basic Roadway Characteristics?		-	
What is the width of the sidewalk?		7-6'	7-6'
Is the sidewalk in good repair?		Even, Smooth Surface	Even, Smooth Surface
Does the sidewalk provide a continuous pedestrian environment?		Frequent Driveway Curb Cuts into the Sidewalk Zone	Driveway Curb Cuts Out of the Sidewalk Zone
Is there a landscape buffer and street trees?		No Landscaping	No Landscaping
What is the prevailing speed?		30	30
Number of Travel Lanes?		2	2
Is lighting present?		Pedestrian-Scale	No Lighting
What is the percent of heavy vehicles in curbside travel lane? (Use total percentage if by-lane data is not available. Percentage should not include transit vehicles.)		< =5%	< =5%
(Optional) What is the crosswalk frequency?		Crosswalks Spaced > 400'	Crosswalks Spaced > 400'
Street Score+ LTS Score		3	4



Intro Card

Input For General Roadway Characteristics		Dir1 - WB	Dir2 - EB
Roadway Variables		El Camino Av	El Camino Av
Roadway Name		Western Av to Colfax St	Western Av to Colfax St
Roadway Extents		12001-15000	12001-15000
ADT (average daily traffic)		30	30
Prevailing Speed in MPH (use posted speed limit if speed data is not available)		No	No
Are the bicycle conditions the same in both directions? (e.g. bicycle facilities are the same in both directions, number of lanes are the same in both directions)		No	No
Are the pedestrian conditions the same in both directions? (e.g. sidewalk of similar width present on both sides of the street, number of lanes are the same in both directions)		No	No
Is there a raised median?		No	No
Number of Total Travel Lanes		2	2



Bike Score by Link

Refer to StreetScore+ white paper for criteria definitions.

Bike StreetScore by Link		Dir1 - WB Input	Dir 2 - EB Input
View Basic Roadway Characteristics?			
What is the bicycle facility type?		Bicycle Lane	Bicycle Lane
Speed		30	30
# of Travel Lanes		2	2
Is the bikeway frequently blocked?		No	No
Is there on-street parking?		No	No
What is the bicycle lane width?		<5'	<5'
Is there a raised median present?		No	No
Segment LTS Score Per Mineta Methodology		3	3
Street Score+ LTS Score		3	3

StreetScore+

Pedestrian Score by Link

Refer to StreetScore+ white paper for criteria definitions.

Pedestrian Streetscore by Link		Dir1 - WB Input	Dir2 - EB Input
View Basic Roadway Characteristics?			
What is the width of the sidewalk?	<6'	<6'	<6'
Is the sidewalk in good repair?	Even, Smooth Surface	Even, Smooth Surface	Even, Smooth Surface
Does the sidewalk provide a continuous pedestrian environment?	Driveway Curb Cuts Out of the Sidewalk Zone	Driveway Curb Cuts Out of the Sidewalk Zone	Driveway Curb Cuts Out of the Sidewalk Zone
Is there a landscape buffer and street trees?	Yes, Continuous	Yes, Continuous	Yes, Continuous
What is the prevailing speed?	30	30	30
Number of Travel Lanes?	2	2	2
Is lighting present?	Pedestrian-Scale	Pedestrian-Scale	Pedestrian-Scale
What is the percent of heavy vehicles in curbside travel lane? (Use total percentage if by-lane data is not available. Percentage should not include transit vehicles.)	<=5%	<=5%	<=5%
(Optional) What is the crosswalk frequency?	Crosswalks Spaced > 400'	Crosswalks Spaced > 400'	Crosswalks Spaced > 400'
Street Score+ LTS Score	3	3	3



Intro Card

Input For General Roadway Characteristics		Dir1 - WB	Dir2 - EB
Roadway Variables		El Camino Av	El Camino Av
Roadway Name		Colfax St to Edgewater Rd	Colfax St to Edgewater Rd
Roadway Extents		12001-15000	12001-15000
ADT (average daily traffic)		30	30
Prevailing Speed in MPH (use posted speed limit if speed data is not available)		No	No
Are the bicycle conditions the same in both directions? (e.g. bicycle facilities are the same in both directions, number of lanes are the same in both directions)		No	No
Are the pedestrian conditions the same in both directions? (e.g. sidewalk of similar width present on both sides of the street, number of lanes are the same in both directions)		No	No
Is there a raised median?		No	No
Number of Total Travel Lanes		2	2



Bike Score
by Link

Refer to StreetScore+ white paper for criteria definitions.

Bike StreetScore by Link		Dir1 - WB Input	Dir 2 - EB Input
View Basic Roadway Characteristics?			
What is the bicycle facility type?		Bicycle Lane	Bicycle Lane
Speed		30	30
# of Travel Lanes		2	2
Is the bikeway frequently blocked?		No	No
Is there on-street parking?		No	No
What is the bicycle lane width?		<5'	<5'
Is there a raised median present?		No	No
Segment LTS Score Per Mineta Methodology		3	3
Street Score+ LTS Score		3	3

StreetScore+

Pedestrian Score by Link

Refer to StreetScore+ white paper for criteria definitions.

Pedestrian Streetscore by Link	Dir1 - WB Input	Dir2 - EB Input
View Basic Roadway Characteristics?	-	-
What is the width of the sidewalk?	<6'	<6'
Is the sidewalk in good repair?	Even, Smooth Surface	Even, Smooth Surface
Does the sidewalk provide a continuous pedestrian environment?	Driveway Curb Cuts Out of the Sidewalk Zone	Driveway Curb Cuts Out of the Sidewalk Zone
Is there a landscape buffer and street trees?	Yes, Continuous	Yes, Continuous
What is the prevailing speed?	30	30
Number of Travel Lanes?	2	2
Is lighting present?	Pedestrian-Scale	Pedestrian-Scale
What is the percent of heavy vehicles in curbside travel lane? (Use total percentage if by-lane data is not available. Percentage should not include transit vehicles.)	<=5%	<=5%
(Optional) What is the crosswalk frequency?	Crosswalks Spaced > 400'	Crosswalks Spaced > 400'
Street Score+ LTS Score	3	3



Intro Card

Input For General Roadway Characteristics		Dir1 - WB	Dir2 - EB
Roadway Variables		El Camino Av	El Camino Av
Roadway Name		Edgewater Rd to Grove Av	Edgewater Rd to Grove Av
Roadway Extents		12001-15000	12001-15000
ADT (average daily traffic)		30	30
Prevailing Speed in MPH (use posted speed limit if speed data is not available)		No	No
Are the bicycle conditions the same in both directions? (e.g. bicycle facilities are the same in both directions, number of lanes are the same in both directions)		No	No
Are the pedestrian conditions the same in both directions? (e.g. sidewalk of similar width present on both sides of the street, number of lanes are the same in both directions)		No	No
Is there a raised median?		No	No
Number of Total Travel Lanes		2	2



Bike Score by Link

Refer to StreetScore+ white paper for criteria definitions.

Bike StreetScore by Link		Dir1 - WB Input	Dir 2 - EB Input
View Basic Roadway Characteristics?			
What is the bicycle facility type?		Bicycle Lane	Bicycle Lane
Speed		30	30
# of Travel Lanes		2	2
Is the bikeway frequently blocked?		No	No
Is there on-street parking?		No	No
What is the bicycle lane width?		<5'	<5'
Is there a raised median present?		No	No
Segment LTS Score Per Mineta Methodology		3	3
Street Score+ LTS Score		3	3

StreetScore+

Pedestrian Score by Link

Refer to StreetScore+ white paper for criteria definitions.

Pedestrian Streetscore by Link		Dir1 - WB Input	Dir2 - EB Input
View Basic Roadway Characteristics?			
What is the width of the sidewalk?	<6'	<6'	<6'
Is the sidewalk in good repair?	Even, Smooth Surface	Even, Smooth Surface	Even, Smooth Surface
Does the sidewalk provide a continuous pedestrian environment?	Driveway Curb Cuts Out of the Sidewalk Zone	Driveway Curb Cuts Out of the Sidewalk Zone	Driveway Curb Cuts Out of the Sidewalk Zone
Is there a landscape buffer and street trees?	Yes, Continuous	Yes, Continuous	Yes, Continuous
What is the prevailing speed?	30	30	30
Number of Travel Lanes?	2	2	2
Is lighting present?	Pedestrian-Scale	Pedestrian-Scale	Pedestrian-Scale
What is the percent of heavy vehicles in curbside travel lane? (Use total percentage if by-lane data is not available. Percentage should not include transit vehicles.)	<=5%	<=5%	<=5%
(Optional) What is the crosswalk frequency?	Crosswalks Spaced > 400'	Crosswalks Spaced > 400'	Crosswalks Spaced > 400'
Street Score+ LTS Score	3	3	3



Intro Card

Input For General Roadway Characteristics		Dir1 - WB	Dir2 - EB
Roadway Variables		El Camino Av	El Camino Av
Roadway Name		Grove Av to Altos Av / Hawthorne St	Grove Av to Altos Av / Hawthorne St
Roadway Extents		12001-15000	12001-15000
ADT (average daily traffic)		30	30
Prevailing Speed in MPH (use posted speed limit if speed data is not available)		No	No
Are the bicycle conditions the same in both directions? (e.g. bicycle facilities are the same in both directions, number of lanes are the same in both directions)		No	No
Are the pedestrian conditions the same in both directions? (e.g. sidewalk of similar width present on both sides of the street, number of lanes are the same in both directions)		No	No
Is there a raised median?		No	No
Number of Total Travel Lanes		2	2

StreetScore+

Bike Score
by Link

Refer to StreetScore+ white paper for criteria definitions.

Bike StreetScore by Link		Dir1 - WB Input	Dir 2 - EB Input
View Basic Roadway Characteristics?			
What is the bicycle facility type?		Bicycle Lane	Bicycle Lane
Speed		30	30
# of Travel Lanes		2	2
Is the bikeway frequently blocked?		No	No
Is there on-street parking?		No	No
What is the bicycle lane width?		> =7'	5.5'
Is there a raised median present?		No	No
Segment LTS Score Per Mineta Methodology		3	3
Street Score+ LTS Score		3	3

StreetScore⁺

Pedestrian
Score by
Link

Refer to StreetScore+ white paper for criteria definitions.

	Dir1 - WB Input	Dir2 - EB Input
Pedestrian Streetscore by Link		
View Basic Roadway Characteristics?	-	-
What is the width of the sidewalk?	<6'	<6'
Is the sidewalk in good repair?	Even, Smooth Surface	Even, Smooth Surface
Does the sidewalk provide a continuous pedestrian environment?	Frequent Driveway Curb Cuts into the Sidewalk Zone	Frequent Driveway Curb Cuts into the Sidewalk Zone
Is there a landscape buffer and street trees?	Yes, Discontinuous	No Landscaping
What is the prevailing speed? Number of Travel Lanes?	30	30
Is lighting present?	2	2
What is the percent of heavy vehicles in curbside travel lane? (Use total percentage if by-lane data is not available. Percentage should not include transit vehicles.)	Roadway Lighting Only	Roadway Lighting Only
(Optional) What is the crosswalk frequency?	<=5%	<=5%
	Crosswalks Spaced Every 400' or Less	Crosswalks Spaced Every 400' or Less
Street Score+ LTS Score	3	3



Intro Card

Input For General Roadway Characteristics		Dir1 - WB	Dir2 - EB
Roadway Variables		El Camino Av	El Camino Av
Roadway Name		Altos Av / Hawthorne St to Forrest St	Altos Av / Hawthorne St to Forrest St
Roadway Extents		12001-15000	12001-15000
ADT (average daily traffic)		30	30
Prevailing Speed in MPH (use posted speed limit if speed data is not available)		No	No
Are the bicycle conditions the same in both directions? (e.g. bicycle facilities are the same in both directions, number of lanes are the same in both directions)		No	No
Are the pedestrian conditions the same in both directions? (e.g. sidewalk of similar width present on both sides of the street, number of lanes are the same in both directions)		No	No
Is there a raised median?		No	No
Number of Total Travel Lanes		2	2



Bike Score
by Link

Refer to StreetScore+ white paper for criteria definitions.

Bike StreetScore by Link		Dir1 - WB Input	Dir 2 - EB Input
View Basic Roadway Characteristics?			
What is the bicycle facility type?		Bicycle Lane	Bicycle Lane
Speed		30	30
# of Travel Lanes		2	2
Is the bikeway frequently blocked?		No	No
Is there on-street parking?		No	No
What is the bicycle lane width?		<5'	5'
Is there a raised median present?		No	No
Segment LTS Score Per Mineta Methodology		3	3
Street Score+ LTS Score		3	3

StreetScore+

Pedestrian Score by Link

Refer to StreetScore+ white paper for criteria definitions.

Pedestrian Streetscore by Link		Dir1 - WB Input	Dir2 - EB Input
View Basic Roadway Characteristics?		-	
What is the width of the sidewalk?		<6'	<6'
Is the sidewalk in good repair?		Cracks, Failing Pavement	Even, Smooth Surface
Does the sidewalk provide a continuous pedestrian environment?		Driveway Curb Cuts Out of the Sidewalk Zone	Frequent Driveway Curb Cuts into the Sidewalk Zone
Is there a landscape buffer and street trees?		Yes, Continuous	No Landscaping
What is the prevailing speed?		30	30
Number of Travel Lanes?		2	2
Is lighting present?		Pedestrian-Scale	Pedestrian-Scale
What is the percent of heavy vehicles in curbside travel lane? (Use total percentage if by-lane data is not available. Percentage should not include transit vehicles.)		< =5%	< =5%
(Optional) What is the crosswalk frequency?		Crosswalks Spaced Every 400' or Less	Crosswalks Spaced Every 400' or Less
Street Score+ LTS Score		4	3



Intro Card

Input For General Roadway Characteristics		Dir1 - WB	Dir2 - EB
Roadway Variables		El Camino Av	El Camino Av
Roadway Name		Forrest St to Fairfield St	Forrest St to Fairfield St
Roadway Extents		12001-15000	12001-15000
ADT (average daily traffic)		30	30
Prevailing Speed in MPH (use posted speed limit if speed data is not available)		No	No
Are the bicycle conditions the same in both directions? (e.g. bicycle facilities are the same in both directions, number of lanes are the same in both directions)		No	No
Are the pedestrian conditions the same in both directions? (e.g. sidewalk of similar width present on both sides of the street, number of lanes are the same in both directions)		No	No
Is there a raised median?		No	No
Number of Total Travel Lanes		2	2



Bike Score
by Link

Refer to StreetScore+ white paper for criteria definitions.

Bike StreetScore by Link		Dir1 - WB Input	Dir 2 - EB Input
View Basic Roadway Characteristics?			
What is the bicycle facility type?		Bicycle Lane	Bicycle Lane
Speed		30	30
# of Travel Lanes		2	2
Is the bikeway frequently blocked?		No	No
Is there on-street parking?		No	No
What is the bicycle lane width?		<5'	<5'
Is there a raised median present?		No	No
Segment LTS Score Per Mineta Methodology		3	3
Street Score+ LTS Score		3	3

StreetScore+

Pedestrian Score by Link

Refer to StreetScore+ white paper for criteria definitions.

Pedestrian Streetscore by Link		Dir1 - WB Input	Dir2 - EB Input
View Basic Roadway Characteristics?			
What is the width of the sidewalk?	<6'	<6'	<6'
Is the sidewalk in good repair?	Even, Smooth Surface	Even, Smooth Surface	Even, Smooth Surface
Does the sidewalk provide a continuous pedestrian environment?	Driveway Curb Cuts Out of the Sidewalk Zone	Driveway Curb Cuts Out of the Sidewalk Zone	Driveway Curb Cuts Out of the Sidewalk Zone
Is there a landscape buffer and street trees?	Yes, Continuous	Yes, Continuous	Yes, Continuous
What is the prevailing speed?	30	30	30
Number of Travel Lanes?	2	2	2
Is lighting present?	Pedestrian-Scale	Pedestrian-Scale	Pedestrian-Scale
What is the percent of heavy vehicles in curbside travel lane? (Use total percentage if by-lane data is not available. Percentage should not include transit vehicles.)	<=5%	<=5%	<=5%
(Optional) What is the crosswalk frequency?	Crosswalks Spaced > 400'	Crosswalks Spaced > 400'	Crosswalks Spaced > 400'
Street Score+ LTS Score	3	3	3



Intro Card

Input For General Roadway Characteristics		Dir1 - WB	Dir2 - EB
Roadway Variables		El Camino Av	El Camino Av
Roadway Name		Fairfield St to Cantalier St	Fairfield St to Cantalier St
Roadway Extents		12001-15000	12001-15000
ADT (average daily traffic)		30	30
Prevailing Speed in MPH (use posted speed limit if speed data is not available)		No	No
Are the bicycle conditions the same in both directions? (e.g. bicycle facilities are the same in both directions, number of lanes are the same in both directions)		No	No
Are the pedestrian conditions the same in both directions? (e.g. sidewalk of similar width present on both sides of the street, number of lanes are the same in both directions)		No	No
Is there a raised median?		No	No
Number of Total Travel Lanes		2	2



Bike Score by Link

Refer to StreetScore+ white paper for criteria definitions.

Bike StreetScore by Link		Dir1 - WB Input	Dir 2 - EB Input
View Basic Roadway Characteristics?			
What is the bicycle facility type?		Bicycle Lane	Bicycle Lane
Speed		30	30
# of Travel Lanes		2	2
Is the bikeway frequently blocked?		No	No
Is there on-street parking?		No	No
What is the bicycle lane width?		<5'	<5'
Is there a raised median present?		No	No
Segment LTS Score Per Mineta Methodology		3	3
Street Score+ LTS Score		3	3

StreetScore+

Pedestrian Score by Link

Refer to StreetScore+ white paper for criteria definitions.

Pedestrian Streetscore by Link		Dir1 - WB Input	Dir2 - EB Input
View Basic Roadway Characteristics?			
What is the width of the sidewalk?	<6'	<6'	<6'
Is the sidewalk in good repair?	Even, Smooth Surface	Even, Smooth Surface	Even, Smooth Surface
Does the sidewalk provide a continuous pedestrian environment?	Driveway Curb Cuts Out of the Sidewalk Zone	Driveway Curb Cuts Out of the Sidewalk Zone	Driveway Curb Cuts Out of the Sidewalk Zone
Is there a landscape buffer and street trees?	Yes, Continuous	Yes, Continuous	Yes, Continuous
What is the prevailing speed?	30	30	30
Number of Travel Lanes?	2	2	2
Is lighting present?	Pedestrian-Scale	Pedestrian-Scale	Pedestrian-Scale
What is the percent of heavy vehicles in curbside travel lane? (Use total percentage if by-lane data is not available. Percentage should not include transit vehicles.)	<=5%	<=5%	<=5%
(Optional) What is the crosswalk frequency?	Crosswalks Spaced > 400'	Crosswalks Spaced > 400'	Crosswalks Spaced > 400'
Street Score+ LTS Score	3	3	3



Intro Card

Input For General Roadway Characteristics		Dir1 - WB	Dir2 - EB
Roadway Variables		El Camino Av	El Camino Av
Roadway Name		Cantallier St to Rio Linda Bl	Cantallier St to Rio Linda Bl
Roadway Extents		12001-15000	12001-15000
ADT (average daily traffic)		30	30
Prevailing Speed in MPH (use posted speed limit if speed data is not available)		No	No
Are the bicycle conditions the same in both directions? (e.g. bicycle facilities are the same in both directions, number of lanes are the same in both directions)		No	No
Are the pedestrian conditions the same in both directions? (e.g. sidewalk of similar width present on both sides of the street, number of lanes are the same in both directions)		No	No
Is there a raised median?		No	No
Number of Total Travel Lanes		2	2



Bike Score by Link

Refer to StreetScore+ white paper for criteria definitions.

Bike StreetScore by Link		Dir1 - WB Input	Dir 2 - EB Input
View Basic Roadway Characteristics?			
What is the bicycle facility type?		Bicycle Lane	Bicycle Route Or No Designated Bikeway
Speed		30	30
# of Travel Lanes		2	2
Is the bikeway frequently blocked?		No	
Is there on-street parking?		No	
What is the bicycle lane width?		<5'	
Is there a raised median present?		No	No
Speed		30	30
# of Travel Lanes		2	2
Does the street have a centerline?			Yes
Is the street classified as residential?			No
Segment LTS Score Per Mineta Methodology		3	3
Street Score+ LTS Score		3	2

StreetScore+

Pedestrian Score by Link

Refer to StreetScore+ white paper for criteria definitions.

	Dir1 - WB Input	Dir2 - EB Input
Pedestrian Streetscore by Link		
View Basic Roadway Characteristics?	-	
What is the width of the sidewalk?	<6'	<6'
Is the sidewalk in good repair?	Even, Smooth Surface	Even, Smooth Surface
Does the sidewalk provide a continuous pedestrian environment?	Driveway Curb Cuts Out of the Sidewalk Zone	Driveway Curb Cuts Out of the Sidewalk Zone
Is there a landscape buffer and street trees?	No Landscaping	No Landscaping
What is the prevailing speed?	30	30
Number of Travel Lanes?	2	2
Is lighting present?	Pedestrian-Scale	No Lighting
What is the percent of heavy vehicles in curbside travel lane? (Use total percentage if by-lane data is not available. Percentage should not include transit vehicles.)	<=5%	<=5%
(Optional) What is the crosswalk frequency?	Crosswalks Spaced > 400'	Crosswalks Spaced > 400'
Street Score+ LTS Score	3	4



Intro Card

Input For General Roadway Characteristics		Dir1 - WB	Dir2 - EB
Roadway Variables		El Camino Av	El Camino Av
Roadway Name		Cantallier St to Rio Linda Bl	Cantallier St to Rio Linda Bl
Roadway Extents		12001-15000	12001-15000
ADT (average daily traffic)		30	30
Prevailing Speed in MPH (use posted speed limit if speed data is not available)		No	No
Are the bicycle conditions the same in both directions? (e.g. bicycle facilities are the same in both directions, number of lanes are the same in both directions)		No	No
Are the pedestrian conditions the same in both directions? (e.g. sidewalk of similar width present on both sides of the street, number of lanes are the same in both directions)		No	No
Is there a raised median?		No	No
Number of Total Travel Lanes		3	3

StreetScore+

Bike Score
by Link

Refer to StreetScore+ white paper for criteria definitions.

	Dir1 - WB Input	Dir 2 - EB Input
Bike StreetScore by Link		
View Basic Roadway Characteristics?		
What is the bicycle facility type?	Bicycle Route Or No Designated Bikeway	Bicycle Route Or No Designated Bikeway
Speed	30	30
# of Travel Lanes	3	3
Does the street have a centerline?	Yes	Yes
Is the street classified as residential?	No	No
Segment LTS Score Per Mineta Methodology	3	3
Street Score+ LTS Score	2	2

StreetScore+

Pedestrian
Score by
Link

Refer to StreetScore+ white paper for criteria definitions.

Pedestrian Streetscore by Link		Dir1 - WB Input	Dir2 - EB Input
View Basic Roadway Characteristics?		-	
What is the width of the sidewalk?		<6'	<6'
Is the sidewalk in good repair?		Even, Smooth Surface	Even, Smooth Surface
Does the sidewalk provide a continuous pedestrian environment?		Frequent Driveway Curb Cuts into the Sidewalk Zone	Frequent Driveway Curb Cuts into the Sidewalk Zone
Is there a landscape buffer and street trees?		No Landscaping	No Landscaping
What is the prevailing speed?		30	30
Number of Travel Lanes?		3	3
Is lighting present?		No Lighting	Roadway Lighting Only
What is the percent of heavy vehicles in curbside travel lane? (Use total percentage if by-lane data is not available. Percentage should not include transit vehicles.)		<=5%	<=5%
(Optional) What is the crosswalk frequency?		Crosswalks Spaced > 400'	Crosswalks Spaced > 400'
Street Score+ LTS Score		4	3



Intro Card

Input For General Roadway Characteristics		Dir1 - WB	Dir2 - EB
Roadway Variables		El Camino Av	El Camino Av
Roadway Name		Rio Linda Bl to Empress St	Rio Linda Bl to Empress St
Roadway Extents		12001-15000	12001-15000
ADT (average daily traffic)		30	30
Prevailing Speed in MPH (use posted speed limit if speed data is not available)		No	No
Are the bicycle conditions the same in both directions? (e.g. bicycle facilities are the same in both directions, number of lanes are the same in both directions)		No	No
Are the pedestrian conditions the same in both directions? (e.g. sidewalk of similar width present on both sides of the street, number of lanes are the same in both directions)		No	No
Is there a raised median?		No	No
Number of Total Travel Lanes		5	5

StreetScore+

Bike Score by Link

Refer to StreetScore+ white paper for criteria definitions.

Bike StreetScore by Link		Dir1 - WB Input	Dir 2 - EB Input
View Basic Roadway Characteristics?			
What is the bicycle facility type?		Bicycle Lane	Bicycle Route Or No Designated Bikeway
Speed		30	30
# of Travel Lanes		5	5
Is the bikeway frequently blocked?		No	
Is there on-street parking?		No	
What is the bicycle lane width?		6'	
Is there a raised median present?		No	No
Speed		30	30
# of Travel Lanes		5	5
Does the street have a centerline?			Yes
Is the street classified as residential?			No
Segment LTS Score Per Mineta Methodology		3	4
Street Score+ LTS Score		3	4

StreetScore+

Pedestrian
Score by
Link

Refer to StreetScore+ white paper for criteria definitions.

Pedestrian Streetscore by Link		Dir1 - WB Input	Dir2 - EB Input
View Basic Roadway Characteristics?		-	
What is the width of the sidewalk?		<6'	<6'
Is the sidewalk in good repair?		Even, Smooth Surface	Even, Smooth Surface
Does the sidewalk provide a continuous pedestrian environment?		Frequent Driveway Curb Cuts into the Sidewalk Zone	Frequent Driveway Curb Cuts into the Sidewalk Zone
Is there a landscape buffer and street trees?		No Landscaping	No Landscaping
What is the prevailing speed?		30	30
Number of Travel Lanes?		5	5
Is lighting present?		Roadway Lighting Only	Roadway Lighting Only
What is the percent of heavy vehicles in curbside travel lane? (Use total percentage if by-lane data is not available. Percentage should not include transit vehicles.)		<=5%	<=5%
(Optional) What is the crosswalk frequency?		Crosswalks Spaced > 400'	Crosswalks Spaced > 400'
Street Score+ LTS Score		3	3



Intro Card

Input For General Roadway Characteristics		Dir1 - WB	Dir2 - EB
Roadway Variables		Dir1 - WB	Dir2 - EB
Roadway Name		Broadway	Broadway
Roadway Extents		38th St to Martin Luther King Jr. BI	38th St to Martin Luther King Jr. BI
ADT (average daily traffic)		> 15000	> 15000
Prevailing Speed in MPH (use posted speed limit if speed data is not available)		25	25
Are the bicycle conditions the same in both directions? (e.g. bicycle facilities are the same in both directions, number of lanes are the same in both directions)		No	No
Are the pedestrian conditions the same in both directions? (e.g. sidewalk of similar width present on both sides of the street, number of lanes are the same in both directions)		No	No
Is there a raised median?		Yes	Yes
Number of Total Travel Lanes		4	4

StreetScore+

Bike Score
by Link

Refer to StreetScore+ white paper for criteria definitions.

Bike StreetScore by Link		Dir1 - WB Input	Dir 2 - EB Input
View Basic Roadway Characteristics?			
What is the bicycle facility type?		Bicycle Lane	Bicycle Lane
Speed		25	25
# of Travel Lanes		4	4
Is the bikeway frequently blocked?		No	No
Is there on-street parking?		No	No
What is the bicycle lane width?		5'	5.5'
Is there a raised median present?		Yes	Yes
Segment LTS Score Per Mineta Methodology		2	2
Street Score+ LTS Score		2	2

StreetScore+

Pedestrian
Score by
Link

Refer to StreetScore+ white paper for criteria definitions.

Pedestrian Streetscore by Link		Dir1 - WB Input	Dir2 - EB Input
View Basic Roadway Characteristics?		-	
What is the width of the sidewalk?		7-6'	7-6'
Is the sidewalk in good repair?		Even, Smooth Surface	Even, Smooth Surface
Does the sidewalk provide a continuous pedestrian environment?		Frequent Driveway Curb Cuts into the Sidewalk Zone	Frequent Driveway Curb Cuts into the Sidewalk Zone
		No Landscaping	No Landscaping
		25	25
		4	4
Is there a landscape buffer and street trees?		Pedestrian-Scale	
What is the prevailing speed? Number of Travel Lanes?		Pedestrian-Scale	
Is lighting present?		Pedestrian-Scale	
What is the percent of heavy vehicles in curbside travel lane? (Use total percentage if by-lane data is not available. Percentage should not include transit vehicles.)		< =5%	
(Optional) What is the crosswalk frequency?		Crosswalks Spaced > 400'	
Street Score+ LTS Score		3	3



Intro Card

Input For General Roadway Characteristics		Dir1 - WB	Dir2 - EB
Roadway Variables		Broadway	Broadway
Roadway Name		Martin Luther King Jr. Bl to 39th St	Martin Luther King Jr. Bl to 39th St
Roadway Extents		> 15000	> 15000
ADT (average daily traffic)		30	30
Prevailing Speed in MPH (use posted speed limit if speed data is not available)		No	No
Are the bicycle conditions the same in both directions? (e.g. bicycle facilities are the same in both directions, number of lanes are the same in both directions)		No	No
Are the pedestrian conditions the same in both directions? (e.g. sidewalk of similar width present on both sides of the street, number of lanes are the same in both directions)		Yes	Yes
Is there a raised median?		5	5
Number of Total Travel Lanes			

StreetScore+

Bike Score
by Link

Refer to StreetScore+ white paper for criteria definitions.

Bike StreetScore by Link		Dir1 - WB Input	Dir 2 - EB Input
View Basic Roadway Characteristics?			
What is the bicycle facility type?		Bicycle Lane	Bicycle Lane
Speed		30	30
# of Travel Lanes		5	5
Is the bikeway frequently blocked?		No	No
Is there on-street parking?		No	Yes
What is the combined bicycle lane and parking lane width?			13.5'
What is the bicycle lane width?		5.5'	
Is there a raised median present?		Yes	Yes
Segment LTS Score Per Mineta Methodology		3	3
Street Score+ LTS Score		3	3

StreetScore+

Pedestrian Score by Link

Refer to StreetScore+ white paper for criteria definitions.

Pedestrian Streetscore by Link		Dir1 - WB Input	Dir2 - EB Input
View Basic Roadway Characteristics?		-	
What is the width of the sidewalk?		<6'	7-6'
Is the sidewalk in good repair?		Even, Smooth Surface	Even, Smooth Surface
Does the sidewalk provide a continuous pedestrian environment?		Frequent Driveway Curb Cuts into the Sidewalk Zone	Driveway Curb Cuts Out of the Sidewalk Zone
Is there a landscape buffer and street trees?		No Landscaping	Yes, Continuous
What is the prevailing speed?		30	30
Number of Travel Lanes?		5	5
Is lighting present?		Roadway Lighting Only	Pedestrian-Scale
What is the percent of heavy vehicles in curbside travel lane? (Use total percentage if by-lane data is not available. Percentage should not include transit vehicles.)		< =5%	< =5%
(Optional) What is the crosswalk frequency?		Crosswalks Spaced Every 400' or Less	Crosswalks Spaced Every 400' or Less
Street Score+ LTS Score		3	2



Intro Card

Input For General Roadway Characteristics		Dir1 - WB	Dir2 - EB
Roadway Variables		Broadway	Broadway
Roadway Name		39th St to Santa Cruz	39th St to Santa Cruz
Roadway Extents		Wy	Wy
ADT (average daily traffic)		> 15000	> 15000
Prevailing Speed in MPH (use posted speed limit if speed data is not available)		30	30
Are the bicycle conditions the same in both directions? (e.g. bicycle facilities are the same in both directions, number of lanes are the same in both directions)		No	No
Are the pedestrian conditions the same in both directions? (e.g. sidewalk of similar width present on both sides of the street, number of lanes are the same in both directions)		No	No
Is there a raised median?		No	No
Number of Total Travel Lanes		4	4

StreetScore+

Bike Score
by Link

Refer to StreetScore+ white paper for criteria definitions.

Bike StreetScore by Link		Dir1 - WB Input	Dir 2 - EB Input
View Basic Roadway Characteristics?			
What is the bicycle facility type?		Bicycle Route Or No Designated Bikeway	Bicycle Route Or No Designated Bikeway
Speed		30	30
# of Travel Lanes		4	4
Does the street have a centerline?		Yes	Yes
Is the street classified as residential?		No	No
Segment LTS Score Per Mineta Methodology		4	4
Street Score+ LTS Score		4	4

StreetScore+

Pedestrian
Score by
Link

Refer to StreetScore+ white paper for criteria definitions.

Pedestrian Streetscore by Link		Dir1 - WB Input	Dir2 - EB Input
View Basic Roadway Characteristics?		-	
What is the width of the sidewalk?		7-6'	<6'
Is the sidewalk in good repair?		Even, Smooth Surface	Even, Smooth Surface
Does the sidewalk provide a continuous pedestrian environment?		Frequent Driveway Curb Cuts into the Sidewalk Zone	Frequent Driveway Curb Cuts into the Sidewalk Zone
Is there a landscape buffer and street trees?		No Landscaping	No Landscaping
What is the prevailing speed?		30	30
Number of Travel Lanes?		4	4
Is lighting present?		Roadway Lighting Only	Roadway Lighting Only
What is the percent of heavy vehicles in curbside travel lane? (Use total percentage if by-lane data is not available. Percentage should not include transit vehicles.)		< =5%	< =5%
(Optional) What is the crosswalk frequency?		Crosswalks Spaced > 400'	Crosswalks Spaced > 400'
Street Score+ LTS Score		3	3



Intro Card

Input For General Roadway Characteristics		Dir1 - WB	Dir2 - EB
Roadway Variables		Broadway	Broadway
Roadway Name		Santa Cruz Wy to 42nd St	Santa Cruz Wy to 42nd St
Roadway Extents		> 15000	> 15000
ADT (average daily traffic)		30	30
Prevailing Speed in MPH (use posted speed limit if speed data is not available)		No	No
Are the bicycle conditions the same in both directions? (e.g. bicycle facilities are the same in both directions, number of lanes are the same in both directions)		No	No
Are the pedestrian conditions the same in both directions? (e.g. sidewalk of similar width present on both sides of the street, number of lanes are the same in both directions)		No	No
Is there a raised median?		No	No
Number of Total Travel Lanes		4	4

StreetScore+

Bike Score
by Link

Refer to StreetScore+ white paper for criteria definitions.

Bike StreetScore by Link		Dir1 - WB Input	Dir 2 - EB Input
View Basic Roadway Characteristics?			
What is the bicycle facility type?		Bicycle Route Or No Designated Bikeway	Bicycle Route Or No Designated Bikeway
Speed		30	30
# of Travel Lanes		4	4
Does the street have a centerline?		Yes	Yes
Is the street classified as residential?		No	No
Segment LTS Score Per Mineta Methodology		4	4
Street Score+ LTS Score		4	4

StreetScore+

Pedestrian Score by Link

Refer to StreetScore+ white paper for criteria definitions.

Pedestrian Streetscore by Link		Dir1 - WB Input	Dir2 - EB Input
View Basic Roadway Characteristics?			
What is the width of the sidewalk?	7-6'	<6'	
Is the sidewalk in good repair?	Even, Smooth Surface	Even, Smooth Surface	
Does the sidewalk provide a continuous pedestrian environment?	Driveway Curb Cuts Out of the Sidewalk Zone	Driveway Curb Cuts Out of the Sidewalk Zone	
Is there a landscape buffer and street trees?	No Landscaping	No Landscaping	
What is the prevailing speed?	30	30	
Number of Travel Lanes?	4	4	
Is lighting present?	Pedestrian-Scale	Roadway Lighting Only	
What is the percent of heavy vehicles in curbside travel lane? (Use total percentage if by-lane data is not available. Percentage should not include transit vehicles.)	<=5%	<=5%	
(Optional) What is the crosswalk frequency?	Crosswalks Spaced > 400'	Crosswalks Spaced > 400'	
Street Score+ LTS Score	3	3	3



Intro Card

Input For General Roadway Characteristics		Dir1 - WB	Dir2 - EB
Roadway Variables		Broadway	Broadway
Roadway Name		42nd St to 43rd St	42nd St to 43rd St
Roadway Extents		> 15000	> 15000
ADT (average daily traffic)		30	30
Prevailing Speed in MPH (use posted speed limit if speed data is not available)		No	No
Are the bicycle conditions the same in both directions? (e.g. bicycle facilities are the same in both directions, number of lanes are the same in both directions)		No	No
Are the pedestrian conditions the same in both directions? (e.g. sidewalk of similar width present on both sides of the street, number of lanes are the same in both directions)		No	No
Is there a raised median?		No	No
Number of Total Travel Lanes		4	4

StreetScore+

Bike Score
by Link

Refer to StreetScore+ white paper for criteria definitions.

Bike StreetScore by Link		Dir1 - WB Input	Dir 2 - EB Input
View Basic Roadway Characteristics?			
What is the bicycle facility type?		Bicycle Route Or No Designated Bikeway	Bicycle Route Or No Designated Bikeway
Speed		30	30
# of Travel Lanes		4	4
Does the street have a centerline?		Yes	Yes
Is the street classified as residential?		No	No
Segment LTS Score Per Mineta Methodology		4	4
Street Score+ LTS Score		4	4

StreetScore+

Pedestrian Score by Link

Refer to StreetScore+ white paper for criteria definitions.

Pedestrian Streetscore by Link		Dir1 - WB Input	Dir2 - EB Input
View Basic Roadway Characteristics?		-	
What is the width of the sidewalk?		7-6'	7-6'
Is the sidewalk in good repair?		Even, Smooth Surface	Even, Smooth Surface
Does the sidewalk provide a continuous pedestrian environment?		Driveway Curb Cuts Out of the Sidewalk Zone	Frequent Driveway Curb Cuts into the Sidewalk Zone
Is there a landscape buffer and street trees?		No Landscaping	No Landscaping
What is the prevailing speed?		30	30
Number of Travel Lanes?		4	4
Is lighting present?		Roadway Lighting Only	Roadway Lighting Only
What is the percent of heavy vehicles in curbside travel lane? (Use total percentage if by-lane data is not available. Percentage should not include transit vehicles.)		< =5%	< =5%
(Optional) What is the crosswalk frequency?		Crosswalks Spaced Every 400' or Less	Crosswalks Spaced Every 400' or Less
Street Score+ LTS Score		3	3



Intro Card

Input For General Roadway Characteristics		Dir1 - WB	Dir2 - EB
Roadway Variables		Broadway	Broadway
Roadway Name		43rd St to Stockton BI	43rd St to Stockton BI
Roadway Extents		> 15000	> 15000
ADT (average daily traffic)		30	30
Prevailing Speed in MPH (use posted speed limit if speed data is not available)		No	No
Are the bicycle conditions the same in both directions? (e.g. bicycle facilities are the same in both directions, number of lanes are the same in both directions)		No	No
Are the pedestrian conditions the same in both directions? (e.g. sidewalk of similar width present on both sides of the street, number of lanes are the same in both directions)		No	No
Is there a raised median?		No	No
Number of Total Travel Lanes		5	5



Bike Score by Link

Refer to StreetScore+ white paper for criteria definitions.

Bike StreetScore by Link		Dir1 - WB Input	Dir 2 - EB Input
View Basic Roadway Characteristics?			
What is the bicycle facility type?		Bicycle Lane	Bicycle Route Or No Designated Bikeway
Speed		30	30
# of Travel Lanes		5	5
Is the bikeway frequently blocked?		No	
Is there on-street parking?		No	
What is the bicycle lane width?		5'	
Is there a raised median present?		No	No
Speed		30	30
# of Travel Lanes		5	5
Does the street have a centerline?			Yes
Is the street classified as residential?			No
Segment LTS Score Per Mineta Methodology		3	4
Street Score+ LTS Score		3	4

StreetScore⁺

Pedestrian Score by Link

Refer to StreetScore+ white paper for criteria definitions.

Pedestrian Streetscore by Link		Dir1 - WB Input	Dir2 - EB Input
View Basic Roadway Characteristics?			
What is the width of the sidewalk?		7-6'	7-6'
Is the sidewalk in good repair?		Even, Smooth Surface	Even, Smooth Surface
Does the sidewalk provide a continuous pedestrian environment?		Frequent Driveway Curb Cuts into the Sidewalk Zone	Frequent Driveway Curb Cuts into the Sidewalk Zone
Is there a landscape buffer and street trees?		Yes, Discontinuous	No Landscaping
What is the prevailing speed?		30	30
Number of Travel Lanes?		5	5
Is lighting present?		Roadway Lighting Only	Pedestrian-Scale
What is the percent of heavy vehicles in curbside travel lane? (Use total percentage if by-lane data is not available. Percentage should not include transit vehicles.)		< =5%	< =5%
(Optional) What is the crosswalk frequency?		Crosswalks Spaced > 400'	Crosswalks Spaced > 400'
Street Score+ LTS Score		3	3



Intro Card

Input For General Roadway Characteristics		Dir1 - WB	Dir2 - EB
Roadway Variables		Broadway	Broadway
Roadway Name		Stockton Bl to 49th St	Stockton Bl to 49th St
Roadway Extents		> 15000	> 15000
ADT (average daily traffic)		30	30
Prevailing Speed in MPH (use posted speed limit if speed data is not available)		No	No
Are the bicycle conditions the same in both directions? (e.g. bicycle facilities are the same in both directions, number of lanes are the same in both directions)		No	No
Are the pedestrian conditions the same in both directions? (e.g. sidewalk of similar width present on both sides of the street, number of lanes are the same in both directions)		No	No
Is there a raised median?		No	No
Number of Total Travel Lanes		4	4

StreetScore+

Bike Score by Link

Refer to StreetScore+ white paper for criteria definitions.

Bike StreetScore by Link		Dir1 - WB Input	Dir 2 - EB Input
View Basic Roadway Characteristics?			
What is the bicycle facility type?		Bicycle Lane	Bicycle Route Or No Designated Bikeway
Speed		30	30
# of Travel Lanes		4	4
Is the bikeway frequently blocked?		No	
Is there on-street parking?		No	
What is the bicycle lane width?		6.5'	
Is there a raised median present?		No	No
Speed		30	30
# of Travel Lanes		4	4
Does the street have a centerline?			Yes
Is the street classified as residential?			No
Segment LTS Score Per Mineta Methodology		3	4
Street Score+ LTS Score		3	4

StreetScore+

Pedestrian
Score by
Link

Refer to StreetScore+ white paper for criteria definitions.

Pedestrian Streetscore by Link		Dir1 - WB Input	Dir2 - EB Input
View Basic Roadway Characteristics?		-	
What is the width of the sidewalk?		7-6'	7-6'
Is the sidewalk in good repair?		Even, Smooth Surface	Even, Smooth Surface
Does the sidewalk provide a continuous pedestrian environment?		Frequent Driveway Curb Cuts into the Sidewalk Zone	Frequent Driveway Curb Cuts into the Sidewalk Zone
		No Landscaping	No Landscaping
		30	30
		4	4
		Roadway Lighting Only	Roadway Lighting Only
Is there a landscape buffer and street trees? What is the prevailing speed? Number of Travel Lanes? Is lighting present?		< =5%	< =5%
		Crosswalks Spaced > 400'	Crosswalks Spaced > 400'
What is the percent of heavy vehicles in curbside travel lane? (Use total percentage if by-lane data is not available. Percentage should not include transit vehicles.)			
(Optional) What is the crosswalk frequency?			
Street Score+ LTS Score		3	3



Intro Card

Input For General Roadway Characteristics		Dir1 - SB	Dir2 - NB
Roadway Variables		Stockton BI	Stockton BI
Roadway Name		4th Av to Broadway	4th Av to Broadway
Roadway Extents		> 15000	> 15000
ADT (average daily traffic)		35	35
Prevailing Speed in MPH (use posted speed limit if speed data is not available)		No	No
Are the bicycle conditions the same in both directions? (e.g. bicycle facilities are the same in both directions, number of lanes are the same in both directions)		No	No
Are the pedestrian conditions the same in both directions? (e.g. sidewalk of similar width present on both sides of the street, number of lanes are the same in both directions)		Yes	Yes
Is there a raised median?		4	4
Number of Total Travel Lanes			

StreetScore+

Bike Score
by Link

Refer to StreetScore+ white paper for criteria definitions.

	Dir1 - SB Input	Dir 2 - NB Input
Bike StreetScore by Link		
View Basic Roadway Characteristics?		
What is the bicycle facility type?	Bicycle Route Or No Designated Bikeway	Bicycle Route Or No Designated Bikeway
Speed	35	35
# of Travel Lanes	4	4
Does the street have a centerline?	Yes	Yes
Is the street classified as residential?	No	No
Segment LTS Score Per Mineta Methodology	4	4
Street Score+ LTS Score	4	4

StreetScore+

Pedestrian Score by Link

Refer to StreetScore+ white paper for criteria definitions.

Pedestrian Streetscore by Link		Dir1 - SB Input	Dir2 - NB Input
View Basic Roadway Characteristics?			
What is the width of the sidewalk?		<6'	7-6'
Is the sidewalk in good repair?		Even, Smooth Surface	Even, Smooth Surface
Does the sidewalk provide a continuous pedestrian environment?		Frequent Driveway Curb Cuts into the Sidewalk Zone	Driveway Curb Cuts Out of the Sidewalk Zone
Is there a landscape buffer and street trees?		Yes, Continuous	Yes, Discontinuous
What is the prevailing speed?		35	35
Number of Travel Lanes?		4	4
Is lighting present?		Roadway Lighting Only	Roadway Lighting Only
What is the percent of heavy vehicles in curbside travel lane? (Use total percentage if by-lane data is not available. Percentage should not include transit vehicles.)		<=5%	<=5%
(Optional) What is the crosswalk frequency?		Crosswalks Spaced > 400'	Crosswalks Spaced > 400'
Street Score+ LTS Score		3	3



Intro Card

Input For General Roadway Characteristics		Dir1 - SB	Dir2 - NB
Roadway Variables		Stockton BI	Stockton BI
Roadway Name		Broadway to 7th Av	Broadway to 7th Av
Roadway Extents		> 15000	> 15000
ADT (average daily traffic)		35	35
Prevailing Speed in MPH (use posted speed limit if speed data is not available)		No	No
Are the bicycle conditions the same in both directions? (e.g. bicycle facilities are the same in both directions, number of lanes are the same in both directions)		No	No
Are the pedestrian conditions the same in both directions? (e.g. sidewalk of similar width present on both sides of the street, number of lanes are the same in both directions)		No	No
Is there a raised median?		No	No
Number of Total Travel Lanes		5	5

StreetScore+

Bike Score
by Link

Refer to StreetScore+ white paper for criteria definitions.

Bike StreetScore by Link		Dir1 - SB Input	Dir 2 - NB Input
View Basic Roadway Characteristics?			
What is the bicycle facility type?		Bicycle Lane	Bicycle Lane
Speed		35	35
# of Travel Lanes		5	5
Is the bikeway frequently blocked?		No	No
Is there on-street parking?		No	No
What is the bicycle lane width?		5'	<5'
Is there a raised median present?		No	No
Segment LTS Score Per Mineta Methodology		3	3
Street Score+ LTS Score		3	3

StreetScore+

Pedestrian Score by Link

Refer to StreetScore+ white paper for criteria definitions.

Pedestrian Streetscore by Link		Dir1 - SB Input	Dir2 - NB Input
View Basic Roadway Characteristics?			
What is the width of the sidewalk?		<6'	<6'
Is the sidewalk in good repair?		Even, Smooth Surface	Even, Smooth Surface
Does the sidewalk provide a continuous pedestrian environment?		Frequent Driveway Curb Cuts into the Sidewalk Zone	Driveway Curb Cuts Out of the Sidewalk Zone
Is there a landscape buffer and street trees?		No Landscaping	Yes, Continuous
What is the prevailing speed?		35	35
Number of Travel Lanes?		5	5
Is lighting present?		Roadway Lighting Only	Pedestrian-Scale
What is the percent of heavy vehicles in curbside travel lane? (Use total percentage if by-lane data is not available. Percentage should not include transit vehicles.)		<=5%	<=5%
(Optional) What is the crosswalk frequency?		Crosswalks Spaced > 400'	Crosswalks Spaced > 400'
Street Score+ LTS Score		3	3



Intro Card

Input For General Roadway Characteristics		Dir1 - SB	Dir2 - NB
Roadway Variables		Stockton BI	Stockton BI
Roadway Name		7th Av to 9th Av	7th Av to 9th Av
Roadway Extents		> 15000	> 15000
ADT (average daily traffic)		35	35
Prevailing Speed in MPH (use posted speed limit if speed data is not available)		No	No
Are the bicycle conditions the same in both directions? (e.g. bicycle facilities are the same in both directions, number of lanes are the same in both directions)		No	No
Are the pedestrian conditions the same in both directions? (e.g. sidewalk of similar width present on both sides of the street, number of lanes are the same in both directions)		No	No
Is there a raised median?		No	No
Number of Total Travel Lanes		5	5

StreetScore+

Bike Score
by Link

Refer to StreetScore+ white paper for criteria definitions.

	Dir1 - SB Input	Dir 2 - NB Input
Bike StreetScore by Link		
View Basic Roadway Characteristics?	-	
What is the bicycle facility type?	Bicycle Lane	Bicycle Lane
Speed	35	35
# of Travel Lanes	5	5
Is the bikeway frequently blocked?	No	No
Is there on-street parking?	No	No
What is the bicycle lane width?	5'	5'
Is there a raised median present?	No	No
Segment LTS Score Per Mineta Methodology	3	3
Street Score+ LTS Score	3	3

StreetScore+

Pedestrian
Score by
Link

Refer to StreetScore+ white paper for criteria definitions.

Pedestrian Streetscore by Link		Dir1 - SB Input	Dir2 - NB Input
View Basic Roadway Characteristics?			
What is the width of the sidewalk?		<6'	<6'
Is the sidewalk in good repair?		Even, Smooth Surface	Even, Smooth Surface
Does the sidewalk provide a continuous pedestrian environment?		Driveway Curb Cuts Out of the Sidewalk Zone	Driveway Curb Cuts Out of the Sidewalk Zone
Is there a landscape buffer and street trees?		Yes, Discontinuous	Yes, Continuous
What is the prevailing speed? Number of Travel Lanes?		35	35
Is lighting present?		5	5
What is the percent of heavy vehicles in curbside travel lane? (Use total percentage if by-lane data is not available. Percentage should not include transit vehicles.)		Roadway Lighting Only	Roadway Lighting Only
(Optional) What is the crosswalk frequency?		<=5%	<=5%
		Crosswalks Spaced > 400'	Crosswalks Spaced > 400'
Street Score+ LTS Score		3	3



Intro Card

Input For General Roadway Characteristics		Dir1 - SB	Dir2 - NB
Roadway Variables		Stockton BI	Stockton BI
Roadway Name		9th Av to 11th Av	9th Av to 11th Av
Roadway Extents		> 15000	> 15000
ADT (average daily traffic)		35	35
Prevailing Speed in MPH (use posted speed limit if speed data is not available)		No	No
Are the bicycle conditions the same in both directions? (e.g. bicycle facilities are the same in both directions, number of lanes are the same in both directions)		No	No
Are the pedestrian conditions the same in both directions? (e.g. sidewalk of similar width present on both sides of the street, number of lanes are the same in both directions)		No	No
Is there a raised median?		No	No
Number of Total Travel Lanes		5	5

StreetScore+

Bike Score
by Link

Refer to StreetScore+ white paper for criteria definitions.

	Dir1 - SB Input	Dir 2 - NB Input
Bike StreetScore by Link		
View Basic Roadway Characteristics?	-	
What is the bicycle facility type?	Bicycle Lane	Bicycle Lane
Speed	35	35
# of Travel Lanes	5	5
Is the bikeway frequently blocked?	No	No
Is there on-street parking?	No	No
What is the bicycle lane width?	5.5'	5.5'
Is there a raised median present?	No	No
Segment LTS Score Per Mineta Methodology	3	3
Street Score+ LTS Score	3	3

StreetScore+

Pedestrian Score by Link

Refer to StreetScore+ white paper for criteria definitions.

	Dir1 - SB Input	Dir2 - NB Input
Pedestrian Streetscore by Link		
View Basic Roadway Characteristics?	-	
What is the width of the sidewalk?	<6'	<6'
Is the sidewalk in good repair?	Even, Smooth Surface	Even, Smooth Surface
Does the sidewalk provide a continuous pedestrian environment?	Driveway Curb Cuts Out of the Sidewalk Zone	Driveway Curb Cuts Out of the Sidewalk Zone
Is there a landscape buffer and street trees?	No Landscaping	Yes, Continuous
What is the prevailing speed?	35	35
Number of Travel Lanes?	5	5
Is lighting present?	Roadway Lighting Only	Roadway Lighting Only
What is the percent of heavy vehicles in curbside travel lane? (Use total percentage if by-lane data is not available. Percentage should not include transit vehicles.)	<=5%	<=5%
(Optional) What is the crosswalk frequency?	Crosswalks Spaced > 400'	Crosswalks Spaced > 400'
Street Score+ LTS Score	3	3



Intro Card

Input For General Roadway Characteristics		Dir1 - SB	Dir2 - NB
Roadway Variables		Stockton BI	Stockton BI
Roadway Name		11th Av to 14th Av	11th Av to 14th Av
Roadway Extents		> 15000	> 15000
ADT (average daily traffic)		35	35
Prevailing Speed in MPH (use posted speed limit if speed data is not available)		No	No
Are the bicycle conditions the same in both directions? (e.g. bicycle facilities are the same in both directions, number of lanes are the same in both directions)		No	No
Are the pedestrian conditions the same in both directions? (e.g. sidewalk of similar width present on both sides of the street, number of lanes are the same in both directions)		No	No
Is there a raised median?		No	No
Number of Total Travel Lanes		5	5

StreetScore+

Bike Score
by Link

Refer to StreetScore+ white paper for criteria definitions.

	Dir1 - SB Input	Dir 2 - NB Input
Bike StreetScore by Link		
View Basic Roadway Characteristics?	-	
What is the bicycle facility type?	Bicycle Lane	Bicycle Lane
Speed	35	35
# of Travel Lanes	5	5
Is the bikeway frequently blocked?	No	No
Is there on-street parking?	No	No
What is the bicycle lane width?	5.5'	5'
Is there a raised median present?	No	No
Segment LTS Score Per Mineta Methodology	3	3
Street Score+ LTS Score	3	3

StreetScore+

Pedestrian Score by Link

Refer to StreetScore+ white paper for criteria definitions.

	Dir1 - SB Input	Dir2 - NB Input
Pedestrian Streetscore by Link		
View Basic Roadway Characteristics?	-	-
What is the width of the sidewalk?	<6'	<6'
Is the sidewalk in good repair?	Even, Smooth Surface	Even, Smooth Surface
Does the sidewalk provide a continuous pedestrian environment?	Driveway Curb Cuts Out of the Sidewalk Zone	Driveway Curb Cuts Out of the Sidewalk Zone
Is there a landscape buffer and street trees?	No Landscaping	Yes, Continuous
What is the prevailing speed?	35	35
Number of Travel Lanes?	5	5
Is lighting present?	Roadway Lighting Only	Roadway Lighting Only
What is the percent of heavy vehicles in curbside travel lane? (Use total percentage if by-lane data is not available. Percentage should not include transit vehicles.)	<=5%	<=5%
(Optional) What is the crosswalk frequency?	Crosswalks Spaced > 400'	Crosswalks Spaced > 400'
Street Score+ LTS Score	3	3



Intro Card

Input For General Roadway Characteristics		Dir1 - SB	Dir2 - NB
Roadway Variables		Stockton BI	Stockton BI
Roadway Name		14th Av to 15th Av	14th Av to 15th Av
Roadway Extents		> 15000	> 15000
ADT (average daily traffic)		35	35
Prevailing Speed in MPH (use posted speed limit if speed data is not available)		No	No
Are the bicycle conditions the same in both directions? (e.g. bicycle facilities are the same in both directions, number of lanes are the same in both directions)		No	No
Are the pedestrian conditions the same in both directions? (e.g. sidewalk of similar width present on both sides of the street, number of lanes are the same in both directions)		No	No
Is there a raised median?		No	No
Number of Total Travel Lanes		5	5

StreetScore+

Bike Score
by Link

Refer to StreetScore+ white paper for criteria definitions.

Bike StreetScore by Link		Dir1 - SB Input	Dir 2 - NB Input
View Basic Roadway Characteristics?			
What is the bicycle facility type?		Bicycle Lane	Bicycle Lane
Speed		35	35
# of Travel Lanes		5	5
Is the bikeway frequently blocked?		No	No
Is there on-street parking?		No	No
What is the bicycle lane width?		> =7'	<5'
Is there a raised median present?		No	No
Segment LTS Score Per Mineta Methodology		3	3
Street Score+ LTS Score		3	3

StreetScore+

Pedestrian Score by Link

Refer to StreetScore+ white paper for criteria definitions.

	Dir1 - SB Input	Dir2 - NB Input
Pedestrian Streetscore by Link		
View Basic Roadway Characteristics?	-	
What is the width of the sidewalk?	<6'	<6'
Is the sidewalk in good repair?	Even, Smooth Surface	Even, Smooth Surface
Does the sidewalk provide a continuous pedestrian environment?	Driveway Curb Cuts Out of the Sidewalk Zone	Frequent Driveway Curb Cuts into the Sidewalk Zone
Is there a landscape buffer and street trees?	Yes, Continuous	Yes, Discontinuous
What is the prevailing speed? Number of Travel Lanes?	35	35
Is lighting present?	5	5
What is the percent of heavy vehicles in curbside travel lane? (Use total percentage if by-lane data is not available. Percentage should not include transit vehicles.)	Roadway Lighting Only	Roadway Lighting Only
(Optional) What is the crosswalk frequency?	<=5%	<=5%
	Crosswalks Spaced > 400'	Crosswalks Spaced > 400'
Street Score+ LTS Score	3	3



Intro Card

Input For General Roadway Characteristics		Dir1 - SB	Dir2 - NB
Roadway Variables		Stockton BI	Stockton BI
Roadway Name		Jansen Dr to 37th Av	Jansen Dr to 37th Av
Roadway Extents		> 15000	> 15000
ADT (average daily traffic)		40	40
Prevailing Speed in MPH (use posted speed limit if speed data is not available)		No	No
Are the bicycle conditions the same in both directions? (e.g. bicycle facilities are the same in both directions, number of lanes are the same in both directions)		No	No
Are the pedestrian conditions the same in both directions? (e.g. sidewalk of similar width present on both sides of the street, number of lanes are the same in both directions)		No	No
Is there a raised median?		No	No
Number of Total Travel Lanes		5	5

StreetScore+

Bike Score
by Link

Refer to StreetScore+ white paper for criteria definitions.

Bike StreetScore by Link		Dir1 - SB Input	Dir 2 - NB Input
View Basic Roadway Characteristics?			
What is the bicycle facility type?		Bicycle Lane	Bicycle Lane
Speed		40	40
# of Travel Lanes		5	5
Is the bikeway frequently blocked?		No	No
Is there on-street parking?		No	No
What is the bicycle lane width?		5.5'	5'
Is there a raised median present?		No	No
Segment LTS Score Per Mineta Methodology		4	4
Street Score+ LTS Score		4	4

StreetScore+

Pedestrian Score by Link

Refer to StreetScore+ white paper for criteria definitions.

Pedestrian Streetscore by Link		Dir1 - SB Input	Dir2 - NB Input
View Basic Roadway Characteristics?		-	
What is the width of the sidewalk?		<6'	<6'
Is the sidewalk in good repair?		Even, Smooth Surface	Even, Smooth Surface
Does the sidewalk provide a continuous pedestrian environment?		Frequent Driveway Curb Cuts into the Sidewalk Zone	Frequent Driveway Curb Cuts into the Sidewalk Zone
Is there a landscape buffer and street trees?		No Landscaping	No Landscaping
What is the prevailing speed?		40	40
Number of Travel Lanes?		5	5
Is lighting present?		Roadway Lighting Only	Roadway Lighting Only
What is the percent of heavy vehicles in curbside travel lane? (Use total percentage if by-lane data is not available. Percentage should not include transit vehicles.)		< =5%	< =5%
(Optional) What is the crosswalk frequency?		Crosswalks Spaced > 400'	Crosswalks Spaced > 400'
Street Score+ LTS Score		4	4



Intro Card

Input For General Roadway Characteristics		Dir1 - SB	Dir2 - NB
Roadway Variables		Stockton BI	Stockton BI
Roadway Name		37th Av to McMahan Dr	37th Av to McMahan Dr
Roadway Extents			
ADT (average daily traffic)		> 15000	> 15000
Prevailing Speed in MPH (use posted speed limit if speed data is not available)		40	40
Are the bicycle conditions the same in both directions? (e.g. bicycle facilities are the same in both directions, number of lanes are the same in both directions)		No	No
Are the pedestrian conditions the same in both directions? (e.g. sidewalk of similar width present on both sides of the street, number of lanes are the same in both directions)		No	No
Is there a raised median?		No	No
Number of Total Travel Lanes		5	5

StreetScore+

Bike Score
by Link

Refer to StreetScore+ white paper for criteria definitions.

Bike StreetScore by Link		Dir1 - SB Input	Dir 2 - NB Input
View Basic Roadway Characteristics?			
What is the bicycle facility type?		Bicycle Lane	Bicycle Lane
Speed		40	40
# of Travel Lanes		5	5
Is the bikeway frequently blocked?		No	No
Is there on-street parking?		No	No
What is the bicycle lane width?		5'	5'
Is there a raised median present?		No	No
Segment LTS Score Per Mineta Methodology		4	4
Street Score+ LTS Score		4	4

StreetScore+

Pedestrian Score by Link

Refer to StreetScore+ white paper for criteria definitions.

Pedestrian Streetscore by Link		Dir1 - SB Input	Dir2 - NB Input
View Basic Roadway Characteristics?		-	
What is the width of the sidewalk?		7-6'	7-6'
Is the sidewalk in good repair?		Even, Smooth Surface	Even, Smooth Surface
Does the sidewalk provide a continuous pedestrian environment?		Frequent Driveway Curb Cuts into the Sidewalk Zone	Frequent Driveway Curb Cuts into the Sidewalk Zone
Is there a landscape buffer and street trees?		No Landscaping	No Landscaping
What is the prevailing speed?		40	40
Number of Travel Lanes?		5	5
Is lighting present?		Roadway Lighting Only	Roadway Lighting Only
What is the percent of heavy vehicles in curbside travel lane? (Use total percentage if by-lane data is not available. Percentage should not include transit vehicles.)		< =5%	< =5%
(Optional) What is the crosswalk frequency?		Crosswalks Spaced > 400'	Crosswalks Spaced > 400'
Street Score+ LTS Score		4	4



Intro Card

Input For General Roadway Characteristics		Dir1 - SB	Dir2 - NB
Roadway Variables		Stockton BI	Stockton BI
Roadway Name		McMahon Dr to Lemon Hill Av	McMahon Dr to Lemon Hill Av
Roadway Extents		Hill Av	Hill Av
ADT (average daily traffic)		> 15000	> 15000
Prevailing Speed in MPH (use posted speed limit if speed data is not available)		40	40
Are the bicycle conditions the same in both directions? (e.g. bicycle facilities are the same in both directions, number of lanes are the same in both directions)		No	No
Are the pedestrian conditions the same in both directions? (e.g. sidewalk of similar width present on both sides of the street, number of lanes are the same in both directions)		No	No
Is there a raised median?		No	No
Number of Total Travel Lanes		5	5

StreetScore+

Bike Score
by Link

Refer to StreetScore+ white paper for criteria definitions.

Bike StreetScore by Link		Dir1 - SB Input	Dir 2 - NB Input
View Basic Roadway Characteristics?			
What is the bicycle facility type?		Bicycle Route Or No Designated Bikeway	Bicycle Lane
Speed		40	40
# of Travel Lanes		5	5
Is the bikeway frequently blocked?			No
Is there on-street parking?			No
What is the bicycle lane width?			5'
Is there a raised median present?		No	No
Speed		40	40
# of Travel Lanes		5	5
Does the street have a centerline?		Yes	
Is the street classified as residential?		No	
Segment LTS Score Per Mineta Methodology		4	4
Street Score+ LTS Score		4	4

StreetScore+

Pedestrian Score by Link

Refer to StreetScore+ white paper for criteria definitions.

Pedestrian Streetscore by Link		Dir1 - SB Input	Dir2 - NB Input
View Basic Roadway Characteristics?		-	
What is the width of the sidewalk?		<6'	<6'
Is the sidewalk in good repair?		Even, Smooth Surface	Even, Smooth Surface
Does the sidewalk provide a continuous pedestrian environment?		Frequent Driveway Curb Cuts into the Sidewalk Zone	Frequent Driveway Curb Cuts into the Sidewalk Zone
Is there a landscape buffer and street trees?		No Landscaping	No Landscaping
What is the prevailing speed?		40	40
Number of Travel Lanes?		5	5
Is lighting present?		Roadway Lighting Only	Roadway Lighting Only
What is the percent of heavy vehicles in curbside travel lane? (Use total percentage if by-lane data is not available. Percentage should not include transit vehicles.)		<=5%	<=5%
(Optional) What is the crosswalk frequency?		Crosswalks Spaced > 400'	Crosswalks Spaced > 400'
Street Score+ LTS Score		4	4



Intro Card

Input For General Roadway Characteristics		Dir1 - SB	Dir2 - NB
Roadway Variables		Stockton BI	Stockton BI
Roadway Name		Lemon Hill Av to EI	Lemon Hill Av to EI
Roadway Extents		Paraiso Av	Paraiso Av
ADT (average daily traffic)		> 15000	> 15000
Prevailing Speed in MPH (use posted speed limit if speed data is not available)		40	40
Are the bicycle conditions the same in both directions? (e.g. bicycle facilities are the same in both directions, number of lanes are the same in both directions)		No	No
Are the pedestrian conditions the same in both directions? (e.g. sidewalk of similar width present on both sides of the street, number of lanes are the same in both directions)		No	No
Is there a raised median?		No	No
Number of Total Travel Lanes		5	5



Bike Score
by Link

Refer to StreetScore+ white paper for criteria definitions.

Bike StreetScore by Link		Dir1 - SB Input	Dir 2 - NB Input
View Basic Roadway Characteristics?			
What is the bicycle facility type?		Bicycle Lane	Bicycle Lane
Speed		40	40
# of Travel Lanes		5	5
Is the bikeway frequently blocked?		No	No
Is there on-street parking?		No	No
What is the bicycle lane width?		<5'	<5'
Is there a raised median present?		No	No
Segment LTS Score Per Mineta Methodology		4	4
Street Score+ LTS Score		4	4

StreetScore+

Pedestrian Score by Link

Refer to StreetScore+ white paper for criteria definitions.

Pedestrian Streetscore by Link		Dir1 - SB Input	Dir2 - NB Input
View Basic Roadway Characteristics?		-	
What is the width of the sidewalk?		<6'	<6'
Is the sidewalk in good repair?		Even, Smooth Surface	Even, Smooth Surface
Does the sidewalk provide a continuous pedestrian environment?		Frequent Driveway Curb Cuts into the Sidewalk Zone	Frequent Driveway Curb Cuts into the Sidewalk Zone
Is there a landscape buffer and street trees?		No Landscaping	No Landscaping
What is the prevailing speed?		40	40
Number of Travel Lanes?		5	5
Is lighting present?		Roadway Lighting Only	Roadway Lighting Only
What is the percent of heavy vehicles in curbside travel lane? (Use total percentage if by-lane data is not available. Percentage should not include transit vehicles.)		<=5%	<=5%
(Optional) What is the crosswalk frequency?		Crosswalks Spaced > 400'	Crosswalks Spaced > 400'
Street Score+ LTS Score		4	4



Intro Card

Input For General Roadway Characteristics		Dir1 - SB	Dir2 - NB
Roadway Variables		Stockton BI	Stockton BI
Roadway Name		Lemon Hill Av to Dias Av	Lemon Hill Av to Dias Av
Roadway Extents			
ADT (average daily traffic)		> 15000	> 15000
Prevailing Speed in MPH (use posted speed limit if speed data is not available)		40	40
Are the bicycle conditions the same in both directions? (e.g. bicycle facilities are the same in both directions, number of lanes are the same in both directions)		No	No
Are the pedestrian conditions the same in both directions? (e.g. sidewalk of similar width present on both sides of the street, number of lanes are the same in both directions)		No	No
Is there a raised median?		No	No
Number of Total Travel Lanes		5	5



Bike Score
by Link

Refer to StreetScore+ white paper for criteria definitions.

Bike StreetScore by Link		Dir1 - SB Input	Dir 2 - NB Input
View Basic Roadway Characteristics?			
What is the bicycle facility type?		Bicycle Lane	Bicycle Lane
Speed		40	40
# of Travel Lanes		5	5
Is the bikeway frequently blocked?		No	No
Is there on-street parking?		No	No
What is the bicycle lane width?		<5'	<5'
Is there a raised median present?		No	No
Segment LTS Score Per Mineta Methodology		4	4
Street Score+ LTS Score		4	4

StreetScore+

Pedestrian Score by Link

Refer to StreetScore+ white paper for criteria definitions.

Pedestrian Streetscore by Link		Dir1 - SB Input	Dir2 - NB Input
View Basic Roadway Characteristics?			
What is the width of the sidewalk?		<6'	<6'
Is the sidewalk in good repair?		Even, Smooth Surface	Even, Smooth Surface
Does the sidewalk provide a continuous pedestrian environment?		Frequent Driveway Curb Cuts into the Sidewalk Zone	Frequent Driveway Curb Cuts into the Sidewalk Zone
Is there a landscape buffer and street trees?		No Landscaping	No Landscaping
What is the prevailing speed?		40	40
Number of Travel Lanes?		5	5
Is lighting present?		Roadway Lighting Only	Roadway Lighting Only
What is the percent of heavy vehicles in curbside travel lane? (Use total percentage if by-lane data is not available. Percentage should not include transit vehicles.)		< =5%	< =5%
(Optional) What is the crosswalk frequency?		Crosswalks Spaced > 400'	Crosswalks Spaced > 400'
Street Score+ LTS Score		4	4



Intro Card

Input For General Roadway Characteristics		Dir1 - SB	Dir2 - NB
Roadway Variables		Stockton BI	Stockton BI
Roadway Name		Dias Av to 47th Av / Elder Creek Rd	Dias Av to 47th Av / Elder Creek Rd
Roadway Extents			
ADT (average daily traffic)		> 15000	> 15000
Prevailing Speed in MPH (use posted speed limit if speed data is not available)		40	40
Are the bicycle conditions the same in both directions? (e.g. bicycle facilities are the same in both directions, number of lanes are the same in both directions)		No	No
Are the pedestrian conditions the same in both directions? (e.g. sidewalk of similar width present on both sides of the street, number of lanes are the same in both directions)		No	No
Is there a raised median?		Yes	Yes
Number of Total Travel Lanes		4	4

StreetScore+

Bike Score
by Link

Refer to StreetScore+ white paper for criteria definitions.

	Dir1 - SB Input	Dir 2 - NB Input
Bike StreetScore by Link		
View Basic Roadway Characteristics?	-	
What is the bicycle facility type?	Bicycle Lane	Bicycle Lane
Speed	40	40
# of Travel Lanes	4	4
Is the bikeway frequently blocked?	No	No
Is there on-street parking?	No	No
What is the bicycle lane width?	5'	<5'
Is there a raised median present?	Yes	Yes
Segment LTS Score Per Mineta Methodology	4	4
Street Score+ LTS Score	4	4

StreetScore+

Pedestrian Score by Link

Refer to StreetScore+ white paper for criteria definitions.

Pedestrian Streetscore by Link		Dir1 - SB Input	Dir2 - NB Input
View Basic Roadway Characteristics?			
What is the width of the sidewalk?		7-6'	<6'
Is the sidewalk in good repair?		Even, Smooth Surface	Even, Smooth Surface
Does the sidewalk provide a continuous pedestrian environment?		Frequent Driveway Curb Cuts into the Sidewalk Zone	Frequent Driveway Curb Cuts into the Sidewalk Zone
Is there a landscape buffer and street trees?		No Landscaping	No Landscaping
What is the prevailing speed?		40	40
Number of Travel Lanes?		4	4
Is lighting present?		Roadway Lighting Only	Roadway Lighting Only
What is the percent of heavy vehicles in curbside travel lane? (Use total percentage if by-lane data is not available. Percentage should not include transit vehicles.)		< =5%	< =5%
(Optional) What is the crosswalk frequency?		Crosswalks Spaced > 400'	Crosswalks Spaced > 400'
Street Score+ LTS Score		4	4



Intro Card

Input For General Roadway Characteristics		Dir1 - SB	Dir2 - NB
Roadway Variables		Stockton BI	Stockton BI
Roadway Name		47th Av / Elder Creek Rd to 48th Av	47th Av / Elder Creek Rd to 48th Av
Roadway Extents		> 15000	> 15000
ADT (average daily traffic)		40	40
Prevailing Speed in MPH (use posted speed limit if speed data is not available)		No	No
Are the bicycle conditions the same in both directions? (e.g. bicycle facilities are the same in both directions, number of lanes are the same in both directions)		No	No
Are the pedestrian conditions the same in both directions? (e.g. sidewalk of similar width present on both sides of the street, number of lanes are the same in both directions)		Yes	Yes
Is there a raised median?		4	4
Number of Total Travel Lanes			



Bike Score
by Link

Refer to StreetScore+ white paper for criteria definitions.

Bike StreetScore by Link		Dir1 - SB Input	Dir 2 - NB Input
View Basic Roadway Characteristics?			
What is the bicycle facility type?			
Speed		40	40
# of Travel Lanes		4	4
Is the bikeway frequently blocked?		No	No
Is there on-street parking?		No	No
What is the bicycle lane width?		5'	5.5'
Is there a raised median present?		Yes	Yes
Segment LTS Score Per Mineta Methodology		4	4
Street Score+ LTS Score		4	4

StreetScore+

Pedestrian Score by Link

Refer to StreetScore+ white paper for criteria definitions.

Pedestrian Streetscore by Link		Dir1 - SB Input	Dir2 - NB Input
View Basic Roadway Characteristics?		-	
What is the width of the sidewalk?		<6'	<6'
Is the sidewalk in good repair?		Even, Smooth Surface	Even, Smooth Surface
Does the sidewalk provide a continuous pedestrian environment?		Frequent Driveway Curb Cuts into the Sidewalk Zone	Frequent Driveway Curb Cuts into the Sidewalk Zone
Is there a landscape buffer and street trees?		No Landscaping	No Landscaping
What is the prevailing speed?		40	40
Number of Travel Lanes?		4	4
Is lighting present?		Roadway Lighting Only	Roadway Lighting Only
What is the percent of heavy vehicles in curbside travel lane? (Use total percentage if by-lane data is not available. Percentage should not include transit vehicles.)		< =5%	< =5%
(Optional) What is the crosswalk frequency?		Crosswalks Spaced > 400'	Crosswalks Spaced > 400'
Street Score+ LTS Score		4	4



Intro Card

Input For General Roadway Characteristics		Dir1 - SB	Dir2 - NB
Roadway Variables		Stockton BI	Stockton BI
Roadway Name		48th Av to Fowler Rd / Riza Av	48th Av to Fowler Rd / Riza Av
Roadway Extents		> 15000	> 15000
ADT (average daily traffic)		40	40
Prevailing Speed in MPH (use posted speed limit if speed data is not available)		No	No
Are the bicycle conditions the same in both directions? (e.g. bicycle facilities are the same in both directions, number of lanes are the same in both directions)		No	No
Are the pedestrian conditions the same in both directions? (e.g. sidewalk of similar width present on both sides of the street, number of lanes are the same in both directions)		No	No
Is there a raised median?		No	No
Number of Total Travel Lanes		5	5



Bike Score by Link

Refer to Streetscore+ white paper for criteria definitions.

Bike StreetScore by Link		Dir1 - SB Input	Dir 2 - NB Input
View Basic Roadway Characteristics?			
What is the bicycle facility type?		Bicycle Lane	Bicycle Route Or No Designated Bikeway
Speed		40	40
# of Travel Lanes		5	5
Is the bikeway frequently blocked?		No	
Is there on-street parking?		No	
What is the bicycle lane width?		5'	
Is there a raised median present?		No	No
Speed		40	40
# of Travel Lanes		5	5
Does the street have a centerline?			Yes
Is the street classified as residential?			No
Segment LTS Score Per Mineta Methodology		4	4
Street Score+ LTS Score		4	4

StreetScore+

Pedestrian Score by Link

Refer to StreetScore+ white paper for criteria definitions.

Pedestrian Streetscore by Link		Dir1 - SB Input	Dir2 - NB Input
View Basic Roadway Characteristics?			
What is the width of the sidewalk?		<6'	<6'
Is the sidewalk in good repair?		Even, Smooth Surface	Even, Smooth Surface
Does the sidewalk provide a continuous pedestrian environment?		Frequent Driveway Curb Cuts into the Sidewalk Zone	Frequent Driveway Curb Cuts into the Sidewalk Zone
Is there a landscape buffer and street trees?		No Landscaping	No Landscaping
What is the prevailing speed?		40	40
Number of Travel Lanes?		5	5
Is lighting present?		Roadway Lighting Only	Roadway Lighting Only
What is the percent of heavy vehicles in curbside travel lane? (Use total percentage if by-lane data is not available. Percentage should not include transit vehicles.)		< =5%	< =5%
(Optional) What is the crosswalk frequency?		Crosswalks Spaced > 400'	Crosswalks Spaced > 400'
Street Score+ LTS Score		4	4



Intro Card

Input For General Roadway Characteristics		Dir1 - SB	Dir2 - NB
Roadway Variables		Stockton BI	Stockton BI
Roadway Name		Fowler Rd / Riza Av to Patterson Wy	Fowler Rd / Riza Av to Patterson Wy
Roadway Extents		> 15000	> 15000
ADT (average daily traffic)		40	40
Prevailing Speed in MPH (use posted speed limit if speed data is not available)		No	No
Are the bicycle conditions the same in both directions? (e.g. bicycle facilities are the same in both directions, number of lanes are the same in both directions)		No	No
Are the pedestrian conditions the same in both directions? (e.g. sidewalk of similar width present on both sides of the street, number of lanes are the same in both directions)		No	No
Is there a raised median?		No	No
Number of Total Travel Lanes		5	5



Bike Score by Link

Refer to StreetScore+ white paper for criteria definitions.

Bike StreetScore by Link		Dir1 - SB Input	Dir 2 - NB Input
View Basic Roadway Characteristics?			
What is the bicycle facility type?		Bicycle Lane	Bicycle Route Or No Designated Bikeway
Speed		40	40
# of Travel Lanes		5	5
Is the bikeway frequently blocked?		No	
Is there on-street parking?		Yes	
What is the combined bicycle lane and parking lane width?		< 13'	
Speed		40	40
# of Travel Lanes		5	5
Does the street have a centerline?			Yes
Is the street classified as residential?			No
Segment LTS Score Per Mineta Methodology		4	4
Street Score+ LTS Score		4	4

StreetScore⁺

Pedestrian
Score by
Link

Refer to StreetScore+ white paper for criteria definitions.

Pedestrian Streetscore by Link		Dir1 - SB Input	Dir2 - NB Input
View Basic Roadway Characteristics?			
What is the width of the sidewalk?		<6'	<6'
Is the sidewalk in good repair?		Even, Smooth Surface	Cracks, Failing Pavement
Does the sidewalk provide a continuous pedestrian environment?		Frequent Driveway Curb Cuts into the Sidewalk Zone	Driveway Curb Cuts Out of the Sidewalk Zone
Is there a landscape buffer and street trees?		No Landscaping	No Landscaping
What is the prevailing speed?		40	40
Number of Travel Lanes?		5	5
Is lighting present?		Roadway Lighting Only	Roadway Lighting Only
What is the percent of heavy vehicles in curbside travel lane? (Use total percentage if by-lane data is not available. Percentage should not include transit vehicles.)		< =5%	< =5%
(Optional) What is the crosswalk frequency?		Crosswalks Spaced > 400'	Crosswalks Spaced > 400'
Street Score+ LTS Score		4	4



Intro Card

Input For General Roadway Characteristics		Dir1 - SB	Dir2 - NB
Roadway Variables		Stockton BI	Stockton BI
Roadway Name		Patterson Wy to 65th St	Patterson Wy to 65th St
Roadway Extents		> 15000	> 15000
ADT (average daily traffic)		40	40
Prevaling Speed in MPH (use posted speed limit if speed data is not available)		No	No
Are the bicycle conditions the same in both directions? (e.g. bicycle facilities are the same in both directions, number of lanes are the same in both directions)		No	No
Are the pedestrian conditions the same in both directions? (e.g. sidewalk of similar width present on both sides of the street, number of lanes are the same in both directions)		No	No
Is there a raised median?		No	No
Number of Total Travel Lanes		5	5

StreetScore+

Bike Score
by Link

Refer to StreetScore+ white paper for criteria definitions.

Bike StreetScore by Link		Dir1 - SB Input	Dir 2 - NB Input
View Basic Roadway Characteristics?			
What is the bicycle facility type?		Bicycle Lane	Bicycle Lane
Speed		40	40
# of Travel Lanes		5	5
Is the bikeway frequently blocked?		No	No
Is there on-street parking?		No	No
What is the bicycle lane width?		5.5'	5.5'
Is there a raised median present?		No	No
Segment LTS Score Per Mineta Methodology		4	4
Street Score+ LTS Score		4	4

StreetScore+

Pedestrian Score by Link

Refer to StreetScore+ white paper for criteria definitions.

Pedestrian Streetscore by Link		Dir1 - SB Input	Dir2 - NB Input
View Basic Roadway Characteristics?		-	
What is the width of the sidewalk?		7-6'	7-6'
Is the sidewalk in good repair?		Even, Smooth Surface	Even, Smooth Surface
Does the sidewalk provide a continuous pedestrian environment?		Frequent Driveway Curb Cuts into the Sidewalk Zone	Frequent Driveway Curb Cuts into the Sidewalk Zone
Is there a landscape buffer and street trees?		No Landscaping	No Landscaping
What is the prevailing speed?		40	40
Number of Travel Lanes?		5	5
Is lighting present?		Roadway Lighting Only	Roadway Lighting Only
What is the percent of heavy vehicles in curbside travel lane? (Use total percentage if by-lane data is not available. Percentage should not include transit vehicles.)		< =5%	< =5%
(Optional) What is the crosswalk frequency?		Crosswalks Spaced > 400'	Crosswalks Spaced > 400'
Street Score+ LTS Score		4	4



Intro Card

Input For General Roadway Characteristics		Dir1 - WB	Dir2 - EB
Roadway Variables		Florin Rd	Florin Rd
Roadway Name		Tamoshanter Wy to 24th St	Tamoshanter Wy to 24th St
Roadway Extents		> 15000	> 15000
ADT (average daily traffic)		40	40
Prevailing Speed in MPH (use posted speed limit if speed data is not available)		No	No
Are the bicycle conditions the same in both directions? (e.g. bicycle facilities are the same in both directions, number of lanes are the same in both directions)		No	No
Are the pedestrian conditions the same in both directions? (e.g. sidewalk of similar width present on both sides of the street, number of lanes are the same in both directions)		Yes	Yes
Is there a raised median?		5	5
Number of Total Travel Lanes			

StreetScore+

Bike Score
by Link

Refer to StreetScore+ white paper for criteria definitions.

Bike StreetScore by Link		Dir1 - WB Input	Dir 2 - EB Input
View Basic Roadway Characteristics?			
What is the bicycle facility type?		Bicycle Route Or No Designated Bikeway	Bicycle Route Or No Designated Bikeway
Speed		40	40
# of Travel Lanes		5	5
Does the street have a centerline?		Yes	Yes
Is the street classified as residential?		No	No
Segment LTS Score Per Mineta Methodology		4	4
Street Score+ LTS Score		4	4

StreetScore+

Pedestrian Score by Link

Refer to StreetScore+ white paper for criteria definitions.

Pedestrian Streetscore by Link		Dir1 - WB Input	Dir2 - EB Input
View Basic Roadway Characteristics?		-	-
What is the width of the sidewalk?		<6'	<6'
Is the sidewalk in good repair?		Even, Smooth Surface	Even, Smooth Surface
Does the sidewalk provide a continuous pedestrian environment?		Frequent Driveway Curb Cuts into the Sidewalk Zone	Frequent Driveway Curb Cuts into the Sidewalk Zone
Is there a landscape buffer and street trees?		No Landscaping	No Landscaping
What is the prevailing speed?		40	40
Number of Travel Lanes?		5	5
Is lighting present?		Roadway Lighting Only	Roadway Lighting Only
What is the percent of heavy vehicles in curbside travel lane? (Use total percentage if by-lane data is not available. Percentage should not include transit vehicles.)		< =5%	< =5%
(Optional) What is the crosswalk frequency?		Crosswalks Spaced > 400'	Crosswalks Spaced > 400'
Street Score+ LTS Score		4	4



Intro Card

Input For General Roadway Characteristics		Dir1 - WB	Dir2 - EB
Roadway Variables		Florin Rd	Florin Rd
Roadway Name		24th St to 25th St	24th St to 25th St
Roadway Extents		> 15000	> 15000
ADT (average daily traffic)		40	40
Prevailing Speed in MPH (use posted speed limit if speed data is not available)		No	No
Are the bicycle conditions the same in both directions? (e.g. bicycle facilities are the same in both directions, number of lanes are the same in both directions)		Yes	Yes
Are the pedestrian conditions the same in both directions? (e.g. sidewalk of similar width present on both sides of the street, number of lanes are the same in both directions)		Yes	Yes
Is there a raised median?		5	5
Number of Total Travel Lanes			

StreetScore+

Bike Score by Link

Refer to StreetScore+ white paper for criteria definitions.

Bike StreetScore by Link		Dir1 - WB Input	Dir2 - EB Input
View Basic Roadway Characteristics?			
What is the bicycle facility type?		Bicycle Lane	Bicycle Route Or No Designated Bikeway
Speed		40	40
# of Travel Lanes		5	5
Is the bikeway frequently blocked?		No	
Is there on-street parking?		No	
What is the bicycle lane width?		5'	
Is there a raised median present?		Yes	Yes
Speed		40	40
# of Travel Lanes		5	5
Does the street have a centerline?			Yes
Is the street classified as residential?			No
Segment LTS Score Per Mineta Methodology		4	4
Street Score+ LTS Score		4	4

StreetScore+

Pedestrian Score by Link

Refer to StreetScore+ white paper for criteria definitions.

Pedestrian Streetscore by Link		Dir1 - WB Input	Dir2 - EB Input
View Basic Roadway Characteristics?		-	
What is the width of the sidewalk?		<6'	<6'
Is the sidewalk in good repair?		Even, Smooth Surface	Even, Smooth Surface
Does the sidewalk provide a continuous pedestrian environment?		Frequent Driveway Curb Cuts into the Sidewalk Zone	Frequent Driveway Curb Cuts into the Sidewalk Zone
Is there a landscape buffer and street trees?		No Landscaping	No Landscaping
What is the prevailing speed?		40	40
Number of Travel Lanes?		5	5
Is lighting present?		Roadway Lighting Only	Roadway Lighting Only
What is the percent of heavy vehicles in curbside travel lane? (Use total percentage if by-lane data is not available. Percentage should not include transit vehicles.)		< =5%	< =5%
(Optional) What is the crosswalk frequency?		Crosswalks Spaced > 400'	Crosswalks Spaced > 400'
Street Score+ LTS Score		4	4



Intro Card

Input For General Roadway Characteristics	
Roadway Variables	Dir1 - WB
Roadway Name	Florin Rd
Roadway Extents	25th St to Woodbine Av
ADT (average daily traffic)	> 15000
Prevailing Speed in MPH (use posted speed limit if speed data is not available)	40
Are the bicycle conditions the same in both directions? (e.g. bicycle facilities are the same in both directions, number of lanes are the same in both directions)	No
Are the pedestrian conditions the same in both directions? (e.g. sidewalk of similar width present on both sides of the street, number of lanes are the same in both directions)	Yes
Is there a raised median?	Yes
Number of Total Travel Lanes	5
	Dir2 - EB
	Florin Rd
	25th St to Woodbine Av
	> 15000
	40
	No
	Yes
	Yes
	5

StreetScore+

Bike Score by Link

Refer to StreetScore+ white paper for criteria definitions.

Bike StreetScore by Link		Dir1 - WB Input	Dir2 - EB Input
View Basic Roadway Characteristics?			
What is the bicycle facility type?		Bicycle Lane	Bicycle Route Or No Designated Bikeway
Speed		40	40
# of Travel Lanes		5	5
Is the bikeway frequently blocked?		No	
Is there on-street parking?		No	
What is the bicycle lane width?		5'	
Is there a raised median present?		Yes	Yes
Speed		40	40
# of Travel Lanes		5	5
Does the street have a centerline?			Yes
Is the street classified as residential?			No
Segment LTS Score Per Mineta Methodology		4	4
Street Score+ LTS Score		4	4

StreetScore+

Pedestrian Score by Link

Refer to StreetScore+ white paper for criteria definitions.

Pedestrian Streetscore by Link		Dir1 - WB Input	Dir2 - EB Input
View Basic Roadway Characteristics?		-	
What is the width of the sidewalk?		<6'	<6'
Is the sidewalk in good repair?		Even, Smooth Surface	Even, Smooth Surface
Does the sidewalk provide a continuous pedestrian environment?		Frequent Driveway Curb Cuts into the Sidewalk Zone	Frequent Driveway Curb Cuts into the Sidewalk Zone
Is there a landscape buffer and street trees?		No Landscaping	No Landscaping
What is the prevailing speed?		40	40
Number of Travel Lanes?		5	5
Is lighting present?		Roadway Lighting Only	No Lighting
What is the percent of heavy vehicles in curbside travel lane? (Use total percentage if by-lane data is not available. Percentage should not include transit vehicles.)		<=5%	<=5%
(Optional) What is the crosswalk frequency?		Crosswalks Spaced > 400'	Crosswalks Spaced > 400'
Street Score+ LTS Score		4	4



Intro Card

Input For General Roadway Characteristics	
Roadway Variables	Dir1 - WB
Roadway Name	Florin Rd
Roadway Extents	Woodbine Av to Loma Verde Wy
ADT (average daily traffic)	> 15000
Prevailing Speed in MPH (use posted speed limit if speed data is not available)	40
Are the bicycle conditions the same in both directions? (e.g. bicycle facilities are the same in both directions, number of lanes are the same in both directions)	No
Are the pedestrian conditions the same in both directions? (e.g. sidewalk of similar width present on both sides of the street, number of lanes are the same in both directions)	Yes
Is there a raised median?	No
Number of Total Travel Lanes	5
	Dir2 - EB
	Florin Rd
	Woodbine Av to Loma Verde Wy
	> 15000
	40
	No
	Yes
	No
	5



Bike Score
by Link

Refer to StreetScore+ white paper for criteria definitions.

Bike StreetScore by Link		Dir1 - WB Input	Dir2 - EB Input
View Basic Roadway Characteristics?			
What is the bicycle facility type?		Bicycle Lane	Bicycle Lane
Speed		40	40
# of Travel Lanes		5	5
Is the bikeway frequently blocked?		No	No
Is there on-street parking?		No	No
What is the bicycle lane width?		5'	5'
Is there a raised median present?		No	No
Segment LTS Score Per Mineta Methodology		4	4
Street Score+ LTS Score		4	4

StreetScore+

Pedestrian
Score by
Link

Refer to StreetScore+ white paper for criteria definitions.

Pedestrian Streetscore by Link		Dir1 - WB Input	Dir2 - EB Input
View Basic Roadway Characteristics?		-	-
What is the width of the sidewalk?		<6'	<6'
Is the sidewalk in good repair?		Even, Smooth Surface	Even, Smooth Surface
Does the sidewalk provide a continuous pedestrian environment?		Frequent Driveway Curb Cuts into the Sidewalk Zone	Driveway Curb Cuts Out of the Sidewalk Zone
Is there a landscape buffer and street trees?		No Landscaping	No Landscaping
What is the prevailing speed? Number of Travel Lanes?		40	40
Is lighting present?		5	5
What is the percent of heavy vehicles in curbside travel lane? (Use total percentage if by-lane data is not available. Percentage should not include transit vehicles.)		Roadway Lighting Only	Roadway Lighting Only
(Optional) What is the crosswalk frequency?		< =5%	< =5%
		Crosswalks Spaced > 400'	Crosswalks Spaced > 400'
Street Score+ LTS Score		4	4



Intro Card

Input For General Roadway Characteristics	
Roadway Variables	Dir1 - WB
Roadway Name	Florin Rd
Roadway Extents	Loma Verde Wy to Indian Ln / 29th St
ADT (average daily traffic)	> 15000
Prevailing Speed in MPH (use posted speed limit if speed data is not available)	40
Are the bicycle conditions the same in both directions? (e.g. bicycle facilities are the same in both directions, number of lanes are the same in both directions)	No
Are the pedestrian conditions the same in both directions? (e.g. sidewalk of similar width present on both sides of the street, number of lanes are the same in both directions)	Yes
Is there a raised median?	Yes
Number of Total Travel Lanes	6
	Dir2 - EB
	Florin Rd
	Loma Verde Wy to Indian Ln / 29th St
	> 15000
	40
	No
	Yes
	Yes
	5

StreetScore+

Bike Score
by Link

Refer to StreetScore+ white paper for criteria definitions.

Bike StreetScore by Link		Dir1 - WB Input	Dir2 - EB Input
View Basic Roadway Characteristics?			
What is the bicycle facility type?		Bicycle Lane	Bicycle Lane
Speed		40	40
# of Travel Lanes		6	5
Is the bikeway frequently blocked?		No	No
Is there on-street parking?		No	No
What is the bicycle lane width?		5'	5'
Is there a raised median present?		Yes	Yes
Segment LTS Score Per Mineta Methodology		4	4
Street Score+ LTS Score		4	4

StreetScore+

Pedestrian Score by Link

Refer to StreetScore+ white paper for criteria definitions.

Pedestrian Streetscore by Link		Dir1 - WB Input	Dir2 - EB Input
View Basic Roadway Characteristics?		-	
What is the width of the sidewalk?		<6'	<6'
Is the sidewalk in good repair?		Even, Smooth Surface	Even, Smooth Surface
Does the sidewalk provide a continuous pedestrian environment?		Frequent Driveway Curb Cuts into the Sidewalk Zone	Frequent Driveway Curb Cuts into the Sidewalk Zone
Is there a landscape buffer and street trees?		No Landscaping	No Landscaping
What is the prevailing speed?		40	40
Number of Travel Lanes?		6	5
Is lighting present?		Roadway Lighting Only	Roadway Lighting Only
What is the percent of heavy vehicles in curbside travel lane? (Use total percentage if by-lane data is not available. Percentage should not include transit vehicles.)		<=5%	<=5%
(Optional) What is the crosswalk frequency?		Crosswalks Spaced > 400'	Crosswalks Spaced > 400'
Street Score+ LTS Score		4	4



Intro Card

Input For General Roadway Characteristics	
Roadway Variables	Dir1 - WB
Roadway Name	Florin Rd
Roadway Extents	Indian Ln / 29th St to LRT
ADT (average daily traffic)	> 15000
Prevailing Speed in MPH (use posted speed limit if speed data is not available)	40
Are the bicycle conditions the same in both directions? (e.g. bicycle facilities are the same in both directions, number of lanes are the same in both directions)	No
Are the pedestrian conditions the same in both directions? (e.g. sidewalk of similar width present on both sides of the street, number of lanes are the same in both directions)	Yes
Is there a raised median?	Yes
Number of Total Travel Lanes	4
	Dir2 - EB
	Florin Rd
	Indian Ln / 29th St to LRT
	> 15000
	40
	No
	Yes
	Yes
	4



Bike Score
by Link

Refer to StreetScore+ white paper for criteria definitions.

Bike StreetScore by Link		Dir1 - WB Input	Dir2 - EB Input
View Basic Roadway Characteristics?			
What is the bicycle facility type?		Bicycle Route Or No Designated Bikeway	Bicycle Route Or No Designated Bikeway
Speed		40	40
# of Travel Lanes		4	4
Does the street have a centerline?		Yes	Yes
Is the street classified as residential?		No	No
Segment LTS Score Per Mineta Methodology		4	4
Street Score+ LTS Score		4	4

StreetScore+

Pedestrian Score by Link

Refer to StreetScore+ white paper for criteria definitions.

Pedestrian Streetscore by Link		Dir1 - WB Input	Dir2 - EB Input
View Basic Roadway Characteristics?		-	
What is the width of the sidewalk?		7-6'	7-6'
Is the sidewalk in good repair?		Even, Smooth Surface	Even, Smooth Surface
Does the sidewalk provide a continuous pedestrian environment?		Frequent Driveway Curb Cuts into the Sidewalk Zone	Frequent Driveway Curb Cuts into the Sidewalk Zone
Is there a landscape buffer and street trees?		No Landscaping	No Landscaping
What is the prevailing speed?		40	40
Number of Travel Lanes?		4	4
Is lighting present?		Roadway Lighting Only	Roadway Lighting Only
What is the percent of heavy vehicles in curbside travel lane? (Use total percentage if by-lane data is not available. Percentage should not include transit vehicles.)		< =5%	< =5%
(Optional) What is the crosswalk frequency?		Crosswalks Spaced > 400'	Crosswalks Spaced > 400'
Street Score+ LTS Score		4	4



Intro Card

Input For General Roadway Characteristics	
Roadway Variables	Dir1 - WB
Roadway Name	Florin Rd
Roadway Extents	LRT to Serenity Dr
ADT (average daily traffic)	> 15000
Prevailing Speed in MPH (use posted speed limit if speed data is not available)	40
Are the bicycle conditions the same in both directions? (e.g. bicycle facilities are the same in both directions, number of lanes are the same in both directions)	No
Are the pedestrian conditions the same in both directions? (e.g. sidewalk of similar width present on both sides of the street, number of lanes are the same in both directions)	Yes
Is there a raised median?	Yes
Number of Total Travel Lanes	4

Dir2 - EB	Florin Rd
LRT to Serenity Dr	LRT to Serenity Dr
> 15000	> 15000
40	40
No	No
Yes	Yes
Yes	Yes
4	4



Bike Score by Link

Refer to StreetScore+ white paper for criteria definitions.

Bike StreetScore by Link		Dir1 - WB Input	Dir2 - EB Input
View Basic Roadway Characteristics?			
What is the bicycle facility type?		Bicycle Route Or No Designated Bikeway	Bicycle Route Or No Designated Bikeway
Speed		40	40
# of Travel Lanes		4	4
Does the street have a centerline?		Yes	Yes
Is the street classified as residential?		No	No
Segment LTS Score Per Mineta Methodology		4	4
Street Score+ LTS Score		4	4

StreetScore+

Pedestrian Score by Link

Refer to StreetScore+ white paper for criteria definitions.

Pedestrian Streetscore by Link		Dir1 - WB Input	Dir2 - EB Input
View Basic Roadway Characteristics?			
What is the width of the sidewalk?	<6'	<6'	<6'
Is the sidewalk in good repair?	Even, Smooth Surface	Even, Smooth Surface	Even, Smooth Surface
Does the sidewalk provide a continuous pedestrian environment?	Driveway Curb Cuts Out of the Sidewalk Zone	Driveway Curb Cuts Out of the Sidewalk Zone	Driveway Curb Cuts Out of the Sidewalk Zone
Is there a landscape buffer and street trees?	No Landscaping	No Landscaping	No Landscaping
What is the prevailing speed?	40	40	40
Number of Travel Lanes?	4	4	4
Is lighting present?	Roadway Lighting Only	Roadway Lighting Only	Roadway Lighting Only
What is the percent of heavy vehicles in curbside travel lane? (Use total percentage if by-lane data is not available. Percentage should not include transit vehicles.)	<=5%	<=5%	<=5%
(Optional) What is the crosswalk frequency?	Crosswalks Spaced > 400'	Crosswalks Spaced > 400'	Crosswalks Spaced > 400'
Street Score+ LTS Score	4	4	4



Intro Card

Input For General Roadway Characteristics		Dir1 - WB	Dir2 - EB
Roadway Variables		Florin Rd	Florin Rd
Roadway Name		Indian Ln / 29th St to Luther Burbank HS	Indian Ln / 29th St to Luther Burbank HS
Roadway Extents		> 15000	> 15000
ADT (average daily traffic)		40	40
Prevailing Speed in MPH (use posted speed limit if speed data is not available)		No	No
Are the bicycle conditions the same in both directions? (e.g. bicycle facilities are the same in both directions, number of lanes are the same in both directions)		Yes	Yes
Are the pedestrian conditions the same in both directions? (e.g. sidewalk of similar width present on both sides of the street, number of lanes are the same in both directions)		Yes	Yes
Is there a raised median?		4	4
Number of Total Travel Lanes			

StreetScore+

Bike Score
by Link

Refer to StreetScore+ white paper for criteria definitions.

Bike StreetScore by Link		Dir1 - WB Input	Dir2 - EB Input
View Basic Roadway Characteristics?			
What is the bicycle facility type?		Bicycle Lane	Bicycle Lane
Speed		40	40
# of Travel Lanes		4	4
Is the bikeway frequently blocked?		No	No
Is there on-street parking?		No	No
What is the bicycle lane width?		5'	6.5'
Is there a raised median present?		Yes	Yes
Segment LTS Score Per Mineta Methodology		4	4
Street Score+ LTS Score		4	4

StreetScore+

Pedestrian Score by Link

Refer to StreetScore+ white paper for criteria definitions.

Pedestrian Streetscore by Link		Dir1 - WB Input	Dir2 - EB Input
View Basic Roadway Characteristics?		-	
What is the width of the sidewalk?		<6'	<6'
Is the sidewalk in good repair?		Even, Smooth Surface	Even, Smooth Surface
Does the sidewalk provide a continuous pedestrian environment?		Frequent Driveway Curb Cuts into the Sidewalk Zone	Frequent Driveway Curb Cuts into the Sidewalk Zone
Is there a landscape buffer and street trees?		No Landscaping	No Landscaping
What is the prevailing speed?		40	40
Number of Travel Lanes?		4	4
Is lighting present?		Roadway Lighting Only	Roadway Lighting Only
What is the percent of heavy vehicles in curbside travel lane? (Use total percentage if by-lane data is not available. Percentage should not include transit vehicles.)		<=5%	<=5%
(Optional) What is the crosswalk frequency?		Crosswalks Spaced > 400'	Crosswalks Spaced > 400'
Street Score+ LTS Score		4	4



Intro Card

Input For General Roadway Characteristics		Dir1 - WB	Dir2 - EB
Roadway Variables		Florin Rd	Florin Rd
Roadway Name		Luther Burbank HS to Luther Dr	Luther Burbank HS to Luther Dr
Roadway Extents		> 15000	> 15000
ADT (average daily traffic)		40	40
Prevailing Speed in MPH (use posted speed limit if speed data is not available)		No	No
Are the bicycle conditions the same in both directions? (e.g. bicycle facilities are the same in both directions, number of lanes are the same in both directions)		Yes	Yes
Are the pedestrian conditions the same in both directions? (e.g. sidewalk of similar width present on both sides of the street, number of lanes are the same in both directions)		Yes	Yes
Is there a raised median?		4	4
Number of Total Travel Lanes			

StreetScore+

Bike Score
by Link

Refer to StreetScore+ white paper for criteria definitions.

Bike StreetScore by Link		Dir1 - WB Input	Dir2 - EB Input
View Basic Roadway Characteristics?			
What is the bicycle facility type?		Bicycle Lane	Bicycle Lane
Speed		40	40
# of Travel Lanes		4	4
Is the bikeway frequently blocked?		No	No
Is there on-street parking?		No	No
What is the bicycle lane width?		5'	5'
Is there a raised median present?		Yes	Yes
Segment LTS Score Per Mineta Methodology		4	4
Street Score+ LTS Score		4	4

StreetScore+

Pedestrian Score by Link

Refer to StreetScore+ white paper for criteria definitions.

Pedestrian Streetscore by Link		Dir1 - WB Input	Dir2 - EB Input
View Basic Roadway Characteristics?		-	
What is the width of the sidewalk?		<6'	<6'
Is the sidewalk in good repair?		Even, Smooth Surface	Even, Smooth Surface
Does the sidewalk provide a continuous pedestrian environment?		Frequent Driveway Curb Cuts into the Sidewalk Zone	Frequent Driveway Curb Cuts into the Sidewalk Zone
Is there a landscape buffer and street trees?		No Landscaping	No Landscaping
What is the prevailing speed?		40	40
Number of Travel Lanes?		4	4
Is lighting present?		Roadway Lighting Only	Roadway Lighting Only
What is the percent of heavy vehicles in curbside travel lane? (Use total percentage if by-lane data is not available. Percentage should not include transit vehicles.)		<=5%	<=5%
(Optional) What is the crosswalk frequency?		Crosswalks Spaced > 400'	Crosswalks Spaced > 400'
Street Score+ LTS Score		4	4



Intro Card

Input For General Roadway Characteristics	
Roadway Variables	Dir1 - WB
Roadway Name	Florin Rd
Roadway Extents	Luther Dr to Munson Wy
ADT (average daily traffic)	> 15000
Prevailing Speed in MPH (use posted speed limit if speed data is not available)	40
Are the bicycle conditions the same in both directions? (e.g. bicycle facilities are the same in both directions, number of lanes are the same in both directions)	No
Are the pedestrian conditions the same in both directions? (e.g. sidewalk of similar width present on both sides of the street, number of lanes are the same in both directions)	Yes
Is there a raised median?	Yes
Number of Total Travel Lanes	4
	Dir2 - EB
	Florin Rd
	Luther Dr to Munson Wy
	> 15000
	40
	No
	Yes
	Yes
	4

StreetScore+

Bike Score
by Link

Refer to StreetScore+ white paper for criteria definitions.

Bike StreetScore by Link		Dir1 - WB Input	Dir2 - EB Input
View Basic Roadway Characteristics?			
What is the bicycle facility type?		Bicycle Lane	Bicycle Lane
Speed		40	40
# of Travel Lanes		4	4
Is the bikeway frequently blocked?		No	No
Is there on-street parking?		No	No
What is the bicycle lane width?		5'	5'
Is there a raised median present?		Yes	Yes
Segment LTS Score Per Mineta Methodology		4	4
Street Score+ LTS Score		4	4

StreetScore+

Pedestrian Score by Link

Refer to StreetScore+ white paper for criteria definitions.

Pedestrian Streetscore by Link		Dir1 - WB Input	Dir2 - EB Input
View Basic Roadway Characteristics?			
What is the width of the sidewalk?	<6'	Even, Smooth Surface	<6'
Is the sidewalk in good repair?	Frequent	Even, Smooth Surface	Frequent
Does the sidewalk provide a continuous pedestrian environment?	Driveway Curb Cuts into the Sidewalk Zone	Driveway Curb Cuts into the Sidewalk Zone	Driveway Curb Cuts into the Sidewalk Zone
Is there a landscape buffer and street trees?	No Landscaping	No Landscaping	No Landscaping
What is the prevailing speed?	40	40	40
Number of Travel Lanes?	4	4	4
Is lighting present?	Roadway Lighting Only	Roadway Lighting Only	Roadway Lighting Only
What is the percent of heavy vehicles in curbside travel lane? (Use total percentage if by-lane data is not available. Percentage should not include transit vehicles.)	< =5%	< =5%	< =5%
(Optional) What is the crosswalk frequency?	Crosswalks Spaced > 400'	Crosswalks Spaced > 400'	Crosswalks Spaced > 400'
Street Score+ LTS Score	4	4	4



Intro Card

Input For General Roadway Characteristics	
Roadway Variables	Dir1 - WB
Roadway Name	Florin Rd
Roadway Extents	Munson Wy to Franklin BI
ADT (average daily traffic)	> 15000
Prevailing Speed in MPH (use posted speed limit if speed data is not available)	40
Are the bicycle conditions the same in both directions? (e.g. bicycle facilities are the same in both directions, number of lanes are the same in both directions)	No
Are the pedestrian conditions the same in both directions? (e.g. sidewalk of similar width present on both sides of the street, number of lanes are the same in both directions)	Yes
Is there a raised median?	Yes
Number of Total Travel Lanes	5
	Dir2 - EB
	Florin Rd
	Munson Wy to Franklin BI
	> 15000
	40
	No
	Yes
	Yes
	5

StreetScore+

Bike Score by Link

Refer to StreetScore+ white paper for criteria definitions.

	Dir1 - WB Input	Dir2 - EB Input
Bike StreetScore by Link		
View Basic Roadway Characteristics?	-	
What is the bicycle facility type?	Bicycle Lane	Bicycle Lane
Speed	40	40
# of Travel Lanes	5	5
Is the bikeway frequently blocked?	No	No
Is there on-street parking?	No	No
What is the bicycle lane width?	<5'	6'
Is there a raised median present?	Yes	Yes
Segment LTS Score Per Mineta Methodology	4	4
Street Score+ LTS Score	4	4

StreetScore+

Pedestrian Score by Link

Refer to StreetScore+ white paper for criteria definitions.

Pedestrian Streetscore by Link		Dir1 - WB Input	Dir2 - EB Input
View Basic Roadway Characteristics?		-	
What is the width of the sidewalk?		7-6'	<6'
Is the sidewalk in good repair?		Even, Smooth Surface	Even, Smooth Surface
Does the sidewalk provide a continuous pedestrian environment?		Frequent Driveway Curb Cuts into the Sidewalk Zone	Frequent Driveway Curb Cuts into the Sidewalk Zone
Is there a landscape buffer and street trees?		No Landscaping	No Landscaping
What is the prevailing speed?		40	40
Number of Travel Lanes?		5	5
Is lighting present?		Roadway Lighting Only	Roadway Lighting Only
What is the percent of heavy vehicles in curbside travel lane? (Use total percentage if by-lane data is not available. Percentage should not include transit vehicles.)		< =5%	< =5%
(Optional) What is the crosswalk frequency?		Crosswalks Spaced > 400'	Crosswalks Spaced > 400'
Street Score+ LTS Score		4	4



Vision Zero Top 5 Corridors Study

Community Outreach Summary Report | Phase II

SPRING 2019

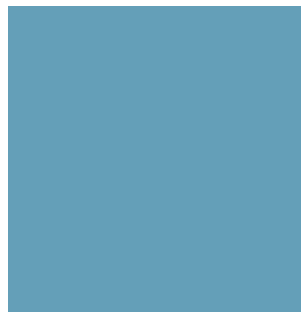

Table of Contents

- 2| About the Study
- 3| Community Outreach Program
- 5| Compilation of Input by Corridor
 - 6| Broadway
 - 8| North Stockton
 - 10| South Stockton
 - 11| Florin
 - 13| Marysville
 - 14| El Camino
- 15| Public Notification
- 16| Appendix



About the Vision Zero Top Five Corridors

In 2017, the City of Sacramento identified five corridors in Sacramento with the highest number of fatal and serious crashes involving pedestrians, bicyclists, and motorists.

The purpose of the Vision Zero Top Five Corridor Study is to analyze the factors that contribute to these corridors' high crash rates and propose counter measures for each corridor that can be implemented near-term. Improvements are based on technical analysis, community input, and best practices in roadway safety and design.

Each of the five corridors span about one mile and are shown on the map to the right and listed below:

Marysville Boulevard

North Avenue to Arcade Boulevard

El Camino Avenue

Del Paso Boulevard to the paved levee trail adjacent to Steelhead Creek

Broadway / Stockton Boulevard

Martin Luther King Jr. Boulevard to 13th Avenue

South Stockton Boulevard

McMahon Drive to Patterson Way

Florin Road

24th Street to Munson Way

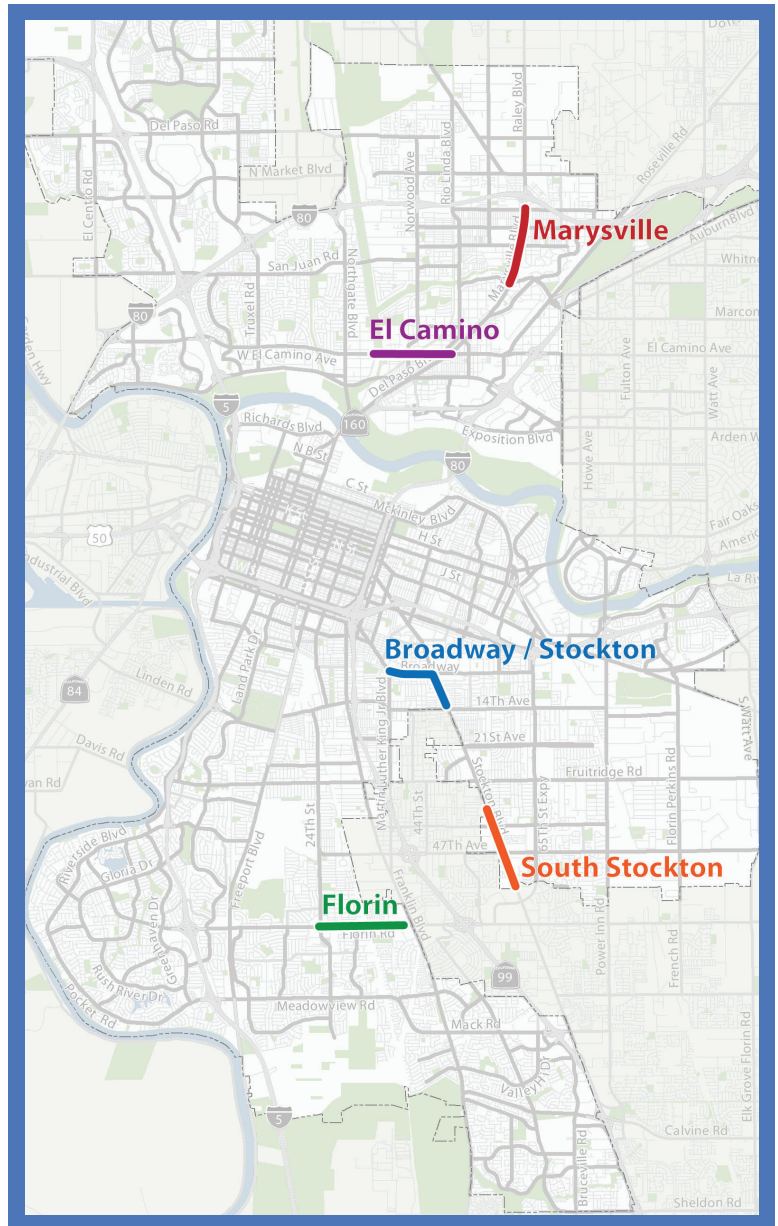

Community Outreach Program

Engaging community members allows the project team to vet their understanding of the existing conditions, explore potential best use practices to improve mobility challenges and to identify ways to assure the improvements will work for the community members.

Technical data and analysis can identify where crashes take place along a corridor, how often they take place, and the types of crashes. However, community input is needed to assure improvements fit within the context of the community. The community outreach program includes two phases:

Phase 1 (October – December 2018)

Objectives

- Build community awareness about the Vision Zero Top Five Corridors Study.
- Present an overview of existing conditions along the top five corridors and potential best practices.
- Obtain community input on the community’s experiences traveling along the top five corridors.

Phase 2 (Spring – Summer 2019)

Objectives

- Present draft countermeasures developed based upon technical analysis, best practices in addressing transportation challenges, and community input.
- Obtain community input on the draft countermeasures at the proposed locations along the corridor.

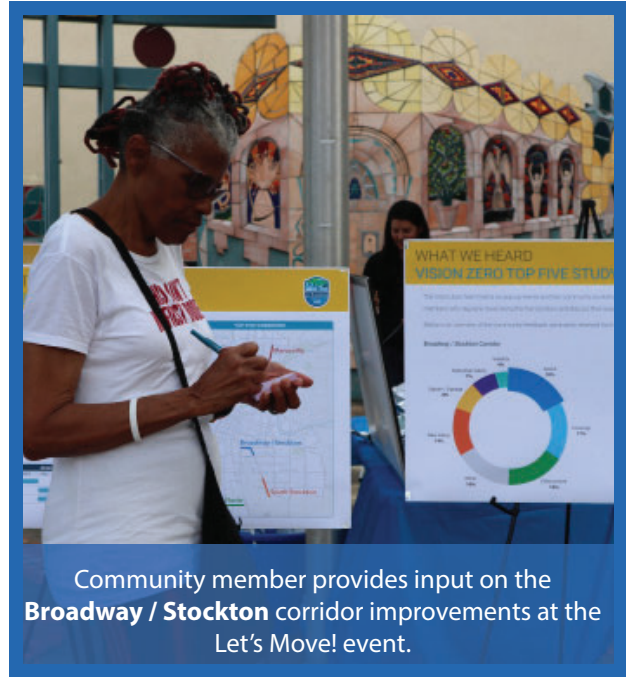

Community member provides input on the **Broadway / Stockton** corridor improvements at the Let’s Move! event.

PROJECT SCHEDULE

	2018												2019				
	May	Jun	Jul	Aug	Sep	Oct	Nov	Dec	Jan	Feb	Mar	Apr	May	Jun	Jul	Aug	Sep
Existing Conditions Analysis	[Bar from May to Oct 2018]																
Corridor Plans Development													[Bar from Oct 2018 to Apr 2019]				
Community Outreach													[Bar from Sep 2018 to Jun 2019]				
Top Five HIN Corridor Study													[Bar from May 2019 to Sep 2019]				

WE ARE HERE!

During this second phase of outreach, the City of Sacramento Vision Zero team held two community open houses and one community event, each within one of two adjacent corridors per meeting.

- May 30** Community Event, “Let’s Move!” for the Broadway-North Stockton corridor
- June 5** Community Open House for the South Stockton and Florin corridors
- June 6** Community Open House for the El Camino and Marysville corridors

The purpose of the community open houses and events were to engage stakeholders, community members, motorists, pedestrians, bicyclists, and transit riders who travel on and live nearby one of the top five corridors in Sacramento. These open houses and events were a key opportunity to build awareness and inform the community about the potential transportation improvements coming to their neighborhood and get their input.

These corridors are located in underrepresented communities within the City. Using traditional community engagement methods can be problematic for these hard-to-reach communities. To address this issue the project team decided to host a community family-friendly celebration at one of the neighborhood parks along the corridor. In conjunction with other City mobility initiatives, the Vision Zero project team developed and implemented “Let’s Move” which featured fun activities around personal movement for adults and children. The project team also collaborated with some of the local businesses along the corridor to participate in the Let’s Move event.

The project team engaged more than 100 community members throughout Phase II of public outreach.

At each of the outreach events, community members were provided informational boards that displayed information relevant to two of the top five corridors depending on the location of each event. The information on the boards included an overview of the project background, crash analytics of each corridor, and a toolkit of proposed corridor-wide and location specific improvements. The new Phase II boards are described below:

WHAT WE HEARD

These boards displayed an overview of the community feedback comments received from Phase I Outreach.

CORRIDOR-WIDE RECOMMENDATIONS

This board displayed a side-by-side comparison of the corridor as it is today, and the recommendations proposed to-scale and their locations along the corridor.

LOCATION-SPECIFIC RECOMMENDATIONS

This board displayed a map of each corridor, highlighting where each of the proposed improvements would be implemented. The purpose of this station was to confirm the project team’s understanding of the community feedback and how the feedback was incorporated into the proposed improvements for each corridor.

IMPROVEMENTS

This board displayed all recommended improvements for each corridor and their descriptions.

The boards listed above can be found in the appendix of this document.

Samples

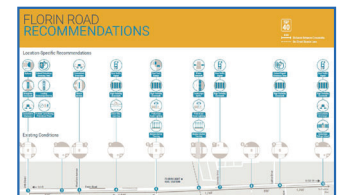
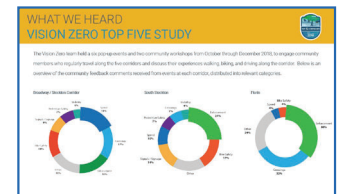

Guided Tai Chi with local kids at the Let’s Move Event.

Compilation of Input by Corridor

The following pages reflect the input received at each community event facilitated by the project team.



Let's Move Event | Broadway / North Stockton Corridor

LET'S MOVE!

On May 31, 2019, the Vision Zero project team collaborated with multiple City-wide transportation projects and hosted the Let's Move Event at McClatchy Park, adjacent to the Broadway / North Stockton top five corridor. The "Let's Move!" event engaged stakeholders, community members, motorists, pedestrians, bicyclists, and transit riders who travel on and live nearby the Broadway / North Stockton corridor in Sacramento. This event was a key opportunity to build awareness and inform the community about ongoing transportation projects and programs, as well as potential transportation improvements coming to their neighborhood.

Participants were given opportunities to contribute their ideas, input, and questions for the Envision Broadway in Oak Park project, the Electric Vehicle Blueprint project, and the City of Sacramento General Plan in addition to the Vision Zero Top Five study.

The event was structured in an open house / festival format and organized around a series of three information stations where attendees were able to review materials, ask questions of staff, and provide their input. The Vision Zero information stations focused on proposed countermeasures for the Broadway / North Stockton corridor. Community members were encouraged to provide their input directly onto the display boards at each information station.

Family-friendly, movement-based activities and games were set-up between each information station. Streamed music played in the background as participants engaged in guided tai chi, flow movement, prompted group painting, a kid's obstacle course, and partner / group games such as twister and connect-four.

Below is the feedback received from each information station pertaining to the Vision Zero Top 5 study .

The full-size board displays from each station can be found in the appendix.



Adrian Engel, Fehr and Peers, discusses the **Envision Broadway Project** with a community member at Let's Move!



Leslie Mancebo, City of Sacramento, discusses the **Vision Zero Top Five Study** with a community member at Let's Move!



Local kids play with bubbles at Let's Move!



Community members at Let's Move!

Broadway Corridor Feedback

Broadway Recommendations

- Intersection 1: Continue to study 4th Avenue & 21st Street
- Intersection 1: Can we fix the approach geometry at Martin Luther King Jr. Boulevard, awkward and jagged movements – it's scary as a bicyclist with the EBR through Pocket onto Martin Luther King Jr. Boulevard.
- Intersection 1: Need to make the area under Highway 99 between Franklin Boulevard and Alhambra more inviting (cleaner and safer)
- Intersection 1: If traffic is diverted to X Street there should be a left turn lane to go from X onto Alhambra.
- Intersection 3: Add an enhanced crossing at a La Solidarid with the road diet.
- Intersection 7: Can we fix the uneven pavement at the light's intersection, traveling west? I must move closer to the inner lane to avoid tire / alignment damage on my car. This pavement is on the outer lane (right side).
- Intersection 10: Consolidate driveways please.
- Overall Parking: Residential parking on Broadway is an issue. Cars stick out in the street.
- Overall Parking: I'm a resident at 5th and T Streets, now retired. I'm taxed with loads of parking meters and have a residence sticker. Any remedy for us retirees on filtered incomes having to pay meters often!

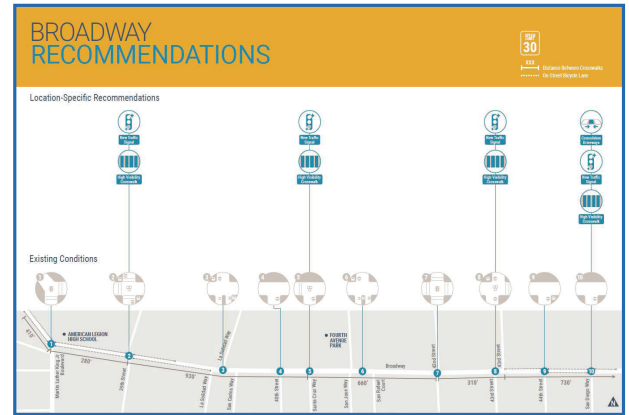

Broadway Location-Specific Recommendations

- Bus lanes or pull-outs for them are needed.
- Keep the bus stops on Broadway.
- I love the separated bike lanes!
- I support these improvements.
- Separation of the bus stop lane (since there are only two lanes going either way.)

Broadway Improvements

- Advanced Dilemma Zone Detection: I like this idea rather than a radar.
- Advanced Dilemma Zone Detection: Radar speed boxes take a photo of the license plate if a car is speeding.
- Advanced Dilemma Zone Detection: Seriously look at attempting to prevent "Yellow Runners."



North Stockton Boulevard Corridor Feedback

North Stockton Recommendations

- Intersection 1: I like the pedestrian scramble
- Intersection 1: The meeting access continuing north of Broadway is awkward, can you consolidate and simplify?
- Intersection 6: Yes please!

North Stockton Location-Specific Recommendations

- Broadway and 2nd Avenue: sidewalk infill north of Broadway, formalize and consolidate access.
- Bus Boarding Islands: More transit shelters and benches with warmth (solar heating).
- Bus Boarding Islands: Aren't buses 0 clearance? Is this needed?
- Bus Boarding Islands: Bus only / HOV lanes. SacRT express and light rail needed.
- Road Diet: A road diet and separated bike lanes all the way to midtown!
- 11th and Stockton: Sidewalks are narrow, and I have ADA concerns through the commercial areas.
- Overall: Consolidate driveways and entry points.
- Overall: More trees and landscaping.
- Overall: Consolidate driveways and add a center median with trees.

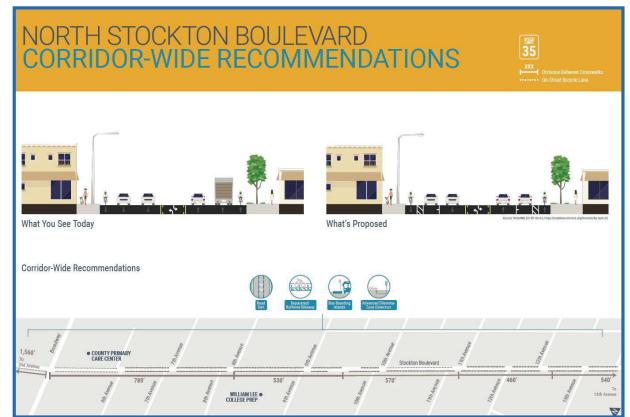
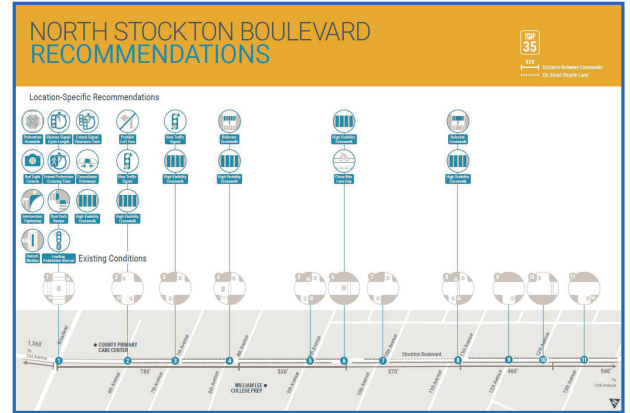

North Stockton Improvements

- Consolidate Driveways: Great idea!
- Intersection Tightening: Bad for trucks.
- Red Light Camera: No thanks.
- Separated / Buffered Bikeway: Yes please!
- Separated / Buffered Bikeway: Buffered bikeway please.



Broadway / North Stockton Corridor | *Online Feedback*

- Please add parking and above all make it safe for cyclists on Stockton Boulevard by adding in the safe cycling lane.
 - ◊ Implement all the changes in the current plan (e.g., two lane traffic reduction with parking and widen the bike lane)
 - ◊ Please extend the cycling lane from 14th Street to San Francisco Boulevard or the Colonial Library. Many of us in the Colonial Heights neighborhood commute to work downtown by bicycle daily.
 - ◊ I anticipate that this change will make Stockton Boulevard a safer road to cycle on, reduce the reckless and currently consistent speeding on Stockton Boulevard, and add to city revenue by helping Stockton businesses get up running again. I fully support these changes.
 - ◊ It is reasonably foreseeable that a extending these changes down Stockton Boulevard to the Colonial Library will reduce blight, boost home prices in the Colonial Heights, and increase city revenue. It may also be a minimal increase to cost that will pay off big for Sacramento!
- Please slow traffic and make this a safe place to walk, ride bikes and use futuristic mobility options like scooters. We want trees for shade. We want to be able to walk our dog safely and without fear of being killed by a motorist. Protected bike lanes are important. Sidewalks that slow traffic and protect us from cars are important.
- Thank you for completing this study! The Broadway / North Stockton corridor feels unsafe. Cars drive very fast and recklessly. To feel safe, cyclists take to the sidewalk or travel against traffic which impacts pedestrians. I'd love to see improvements for all modes of transit that allow all community members safe access to amenities (light rail, etc.) along Broadway and Stockton Boulevard.
- Stockton Boulevard at T Street is a corridor that is only going to get worse with time where a new, huge housing development is going in. Ingress and egress at this building is going to cause an already busy/ dangerous intersection (without dedicated left turn signals except southbound Stockton at T Street) to get even worse.
- Both of these corridors are important and need improvement. I would like to add that our entire city needs improvement and to make bicycle/pedestrian safety a top concern during the planning phase of every roadway. For our city to grow it must take alternate forms of transportation more seriously starting with enforcement on the constant use of bike lanes as loading zones. It does the city no good to spend money on painting bike lanes green when the city could care less about rows and rows of cars parked on them.



Community Open House | South Stockton / Florin Corridors

On June 5th, the Vision Zero project team held a community open house at Luther Burbank High School, located directly on the Florin Road corridor.

Participants were given opportunities to contribute their ideas, input, and questions for the Vision Zero Top Five Study through interactive board displays.

The meeting was structured in an open house format and organized by corridor and organized into two information stations. The information stations focused on proposed countermeasures for the Florin Road and South Stockton corridors as part of the Vision Zero Top Five Study. Community members were encouraged to provide their input directly onto the display boards at each information station.



Rebecca Shafer, Fehr and Peers, discusses the Florin Corridor with a community member.

Below is the feedback received from each information station.

The full-size board displays from each station can be found in the appendix.

South Stockton Boulevard Corridor Feedback

South Stockton Recommendations

- Raised Medians: Some people stand on raised medians when they are too low. Consider higher curbs.
- High visibility crosswalks: Need more of these.
- Pedestrian Crossing time: Extend pedestrian crossing time at Fruitridge Road and Stockton Boulevard.
- Extend Pedestrian Crossing time: This will be useful since many people run red lights.

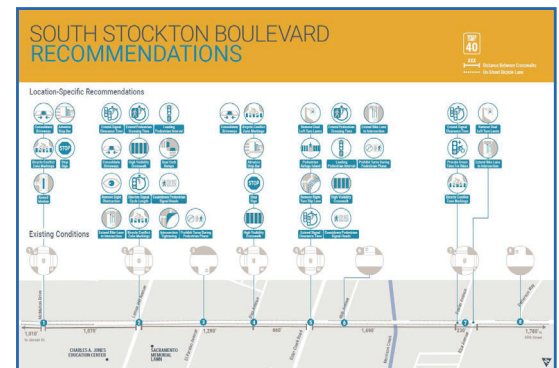

South Stockton Boulevard | Online Feedback

- As a citizen of Sacramento, I am horrified that the five most dangerous corridors in this City are in areas historically under served by city government. This is a clear case of economic injustice. The City should redirect the millions of dollars earmarked for projects in areas over-supplied with bicycle facilities to these far more important projects. In particular, the Two Rivers Trail is not necessary -- there is a parallel trail right across the American River, and the area it serves has a multitude of bicycle facilities. This is a stark case where the City is not walking its talk of commitment to justice for underserved neighborhoods.
- Try to find a parallel route on quieter streets. There is a lot of traffic from delivery trucks to older/more polluting cars in this area. The result is a lot of opportunities for conflict and very poor air quality. It is also not shaded, its bumpy (poor road or manholes in bike lane), and there is a lot of broken glass/debris. These things make it generally unpleasant to ride on Stockton and only the most intense cyclists will use it. I'd love to see it improved, but I think the best way may be to truly focus on a parallel street where there are fewer cars and conflict opportunities. I bike 8 miles from East Sacramento to South Sacramento and I'll only be passed by 10 cars in the neighborhoods. On Stockton, it could be as many as hundreds.

Florin Corridor Feedback

Florin Recommendations

- Intersection 1: Chirping for entire crossing time; more crossing time.
- Intersection 4: Traffic signal needed at Loma Verde.
- Intersection 6: Fix for those with handicaps – right now they must go almost in the street to get around the crossing gate (on both sides).
- Intersection 9: Better visibility and better maintenance needed.
- Intersection 10: Another crosswalk between Franklin Boulevard and Luther Burbank High School is needed.
- Overall: Before repaving, make sure the utilities are working.

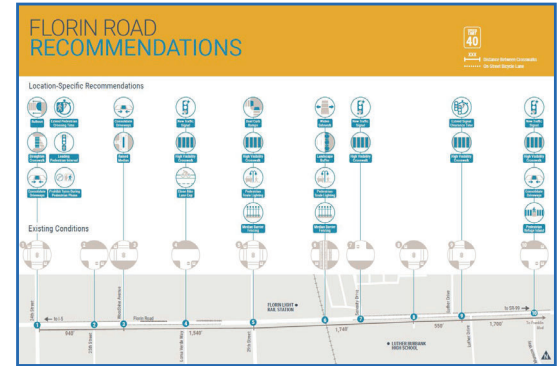

Florin Improvements

- Overall: Crosswalks under the light rail tracks needed.
- Overall: More enforcement needed for wrong-way cycling.
- Overall: How are these improvements helping with the heat island effect?
- Advanced Dilemma-Zone Detection: More stop signs to slow down drivers.
- New traffic signal: more traffic lights needed.
- High visibility crosswalks: More crosswalks.
- Pedestrian Refuge Island: Add more trees; they provide shade and are better for the environment.
- Landscaping: Trees need to be at the forefront of this discussion - they filter particulate matter out of the air, reduce the urban heat island effect (shading asphalt, concrete, and building surfaces that absorb heat while also cooling the air and reducing energy / AC usage), and encourage the use of alternative transportation like walking, cycling, or public transit. Especially in underserved neighborhoods, every street, parking lot, bike path, park, and school should be well shaded.
- Landscape buffer: We like this.



Florin Road | Online Feedback

- My comment is about the reduced speeds in all school areas. Currently, the school signage in my area simply says “25 MPH when children are present”. I am hoping that the new rules and signage are more specific, which is why I believe drivers ignore the current speed limit. I understand it’s difficult to pinpoint specific days/times considering all school activities. Electronic reduced speed signs operate even when the school is closed, so drivers ignore it. How can speed limits be enforced when the sign reading “when children are present” is so vague? Specifying class times and school activities wouldn’t include all afterschool activities, but it would be better.



Community Open House | Marysville / El Camino Corridors

On June 6th, the Vision Zero project team held a community open house at the Greater Sacramento Urban League, located on the Marysville Boulevard corridor.

Participants were given opportunities to contribute their ideas, input, and questions for the Vision Zero Top Five Study through interactive board displays.

The meeting was structured in an open house format and organized by corridor and organized into two information stations. The information stations focused on proposed countermeasures for the Marysville Boulevard and El Camino Avenue corridors as part of the Vision Zero Top Five Study. Community members were encouraged to provide their input directly onto the display boards at each information station.



David Carter, Fehr and Peers, discusses the Marysville Corridor with a community member.

Below is the feedback received from each information station.
The full-size board displays from each station can be found in the appendix.

Marysville Boulevard Corridor Feedback

Marysville Recommendations

- Intersection 8: Class II Bike Lane: Need education for any new features or improvements.
- Intersection 9: Square up intersections and add curb extensions by the park and Grant Union High School.
- Intersection 9: Consider pedestrian scramble where there are a lot of pedestrians, like by Grant Union High School.

Marysville Location-Specific Recommendations

- Overall: widen sidewalks with extra space.
- Overall: Watch for blind spots with parking and separated bike lanes.
- Streetlights: Better lighting (brighter bulbs)
- Parking: Approve on-street parking.

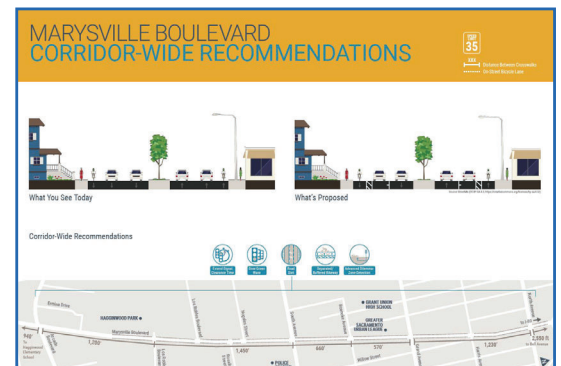
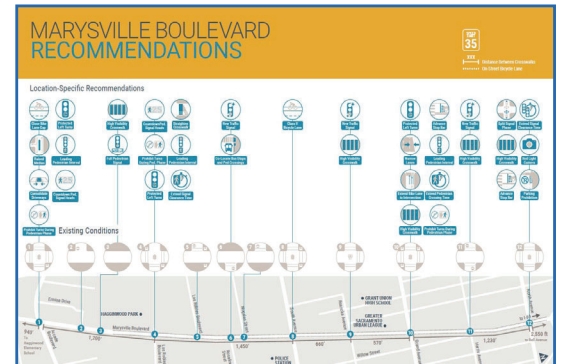

El Camino Avenue Corridor Feedback

El Camino Recommendations

- Overall: Replace and widen bike lanes on El Camino Avenue.
- Overall: The sidewalk gap closure is good.
- Intersection 5: Traction Avenue, west of Jack Park is not needed. Eliminate it!
- Intersection 8: Anything to help with visibility is good at the Rio Linda crossing.
- Intersection 11: Pedestrian Scramble: I like the pedestrian scramble at this intersection. This way pedestrians can move in all directions, and I don't think it would affect traffic too much.
- Intersection 11: Citations are what get peoples' attention when speeding or running lights.

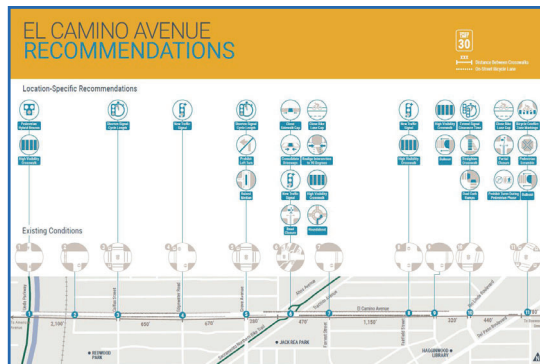

El Camino Avenue | *Online Feedback*

- Need to change El Camino Avenue to possibly four lanes, two each way. Maybe put in some roundabouts. There also needs to be one or two more pedestrian crossing lights and better bike lanes.
- I live on El Camino Avenue, across from Cantalier Street and have noticed many senior neighbors trying to cross at the cross walk in front of my house at the Cantalier intersection. With the recent purchase of the church across the street there is much more foot traffic at this intersection (which is nice!) but please post better speed signage and paint or make the cross walk more visible as I have had to stop traffic for seniors more than once at this intersection/crossing. A speed bump here may be useful. I support bike lanes on El Camino Avenue and hope additional bike racks are added to the highly walkable area along with bike rentals. Please consider adding public water fountains near bike racks or bike friendly areas along this route as well. It's hot and cyclists or pedestrians could use water fountain breaks.

Public Notification

The project team completed an extensive notification process for the Let's Move community event and each community open house. The purpose of creating and completing such an extensive notification plan was to inform the public about the project, its goals, and ask community members who were notified to share the project and event information with their fellow communities.

For each event, a list of businesses, community associations, and individuals were notified by phone and email to share the event information with their organization along the adjacent corridor. A general email was also sent to all individuals who signed up throughout the City of Sacramento's email database for their specific corridor.

Below is a list of organizations and groups who helped share information about the project and events through email, social media, or printed flyer:

- AARP
- A World of Tomorrow
- Broadway Coffee
- City of Sacramento
- Classy Hippie Tea Company
- Councilmember Larry Carr, District 8
- Councilmember Jay Schenrier, District 5
- Councilmember Allen Warren, District 2
- Inn off Capitol Park
- Oak Park Art Garden
- Old Soul Broadway
- Next Door
- North Sacramento Beat
- North Sacramento Chamber of Commerce
- Sac365
- Sacramento Area Bicycle Advocates (SABA)
- Sacramento Building Healthy Communities (SacBHC)
- Sacramento Regional Baptist Church
- Sacramento State
- SacTRU
- Sierra 2 Center
- Stockton Boulevard Partnership
- Strapping Store
- Vibe Health Bar
- WALK Sacramento



Appendix

■ Project Boards

- What We Heard
- Broadway
- North Stockton
- South Stockton
- Florin
- Marysville
- El Camino

■ Public Notification Flyers

ABOUT THE VISION ZERO TOP FIVE STUDY

In 2017, the City of Sacramento identified the five corridors in Sacramento with the **highest numbers of fatal and serious crashes** involving pedestrians, bicyclists, and motorists.

The Vision Zero Top Five Corridor Study is analyzing the factors that contribute to these corridors' high crash rates.

Based on **technical analysis, community input, and best practices in roadway safety and design**, the study will identify improvements for each of these corridors that can be implemented in the near-term.

Project Schedule

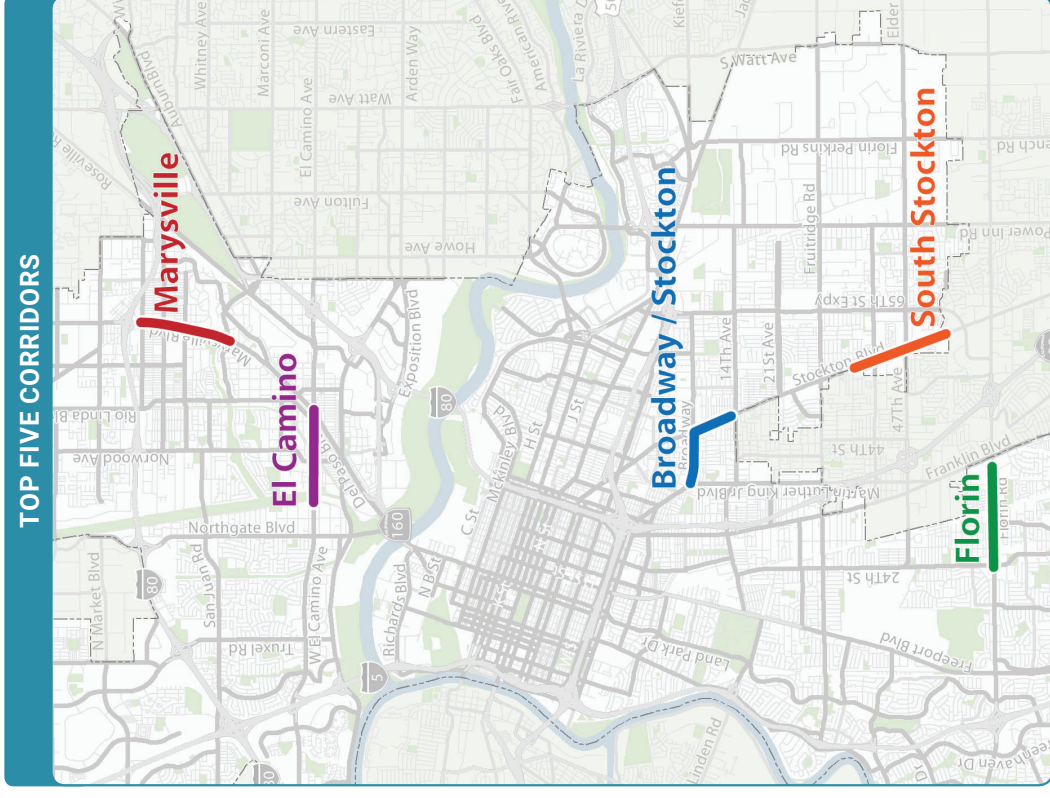
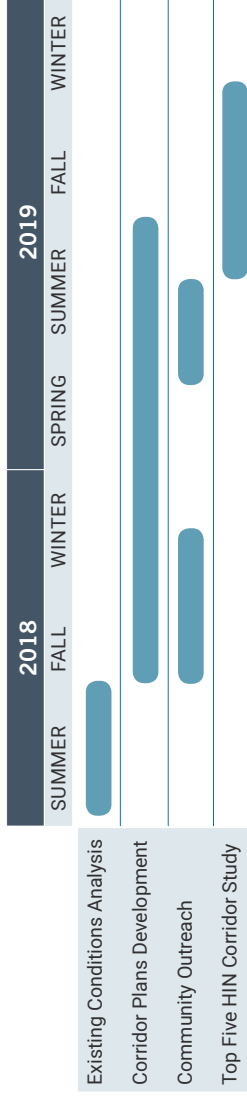

WHAT WE HEARD VISION ZERO TOP FIVE STUDY



The Vision Zero team held a six pop-up events and two community workshops from October through December 2018, to engage community members who regularly travel along the five corridors and discuss their experiences walking, biking, and driving along the corridor. Below is an overview of the community feedback comments received from events at each corridor, distributed into relevant categories.

Broadway / Stockton Corridor

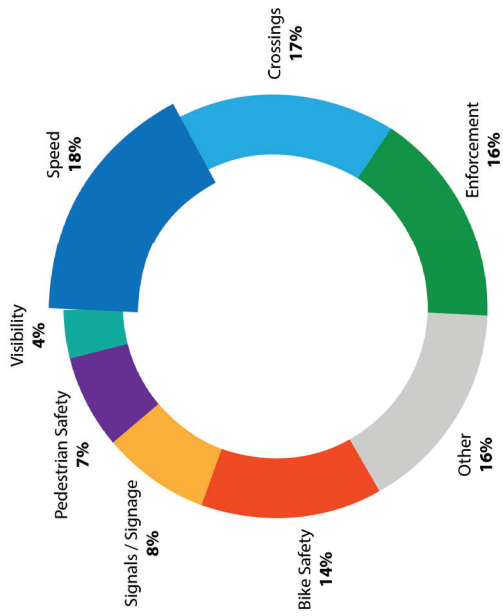

South Stockton

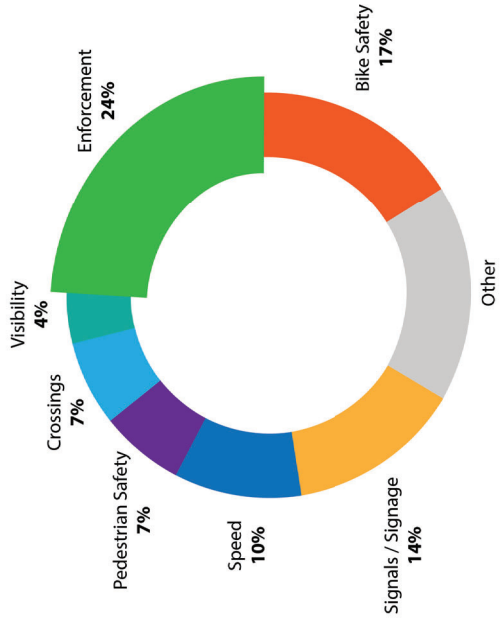

Florin

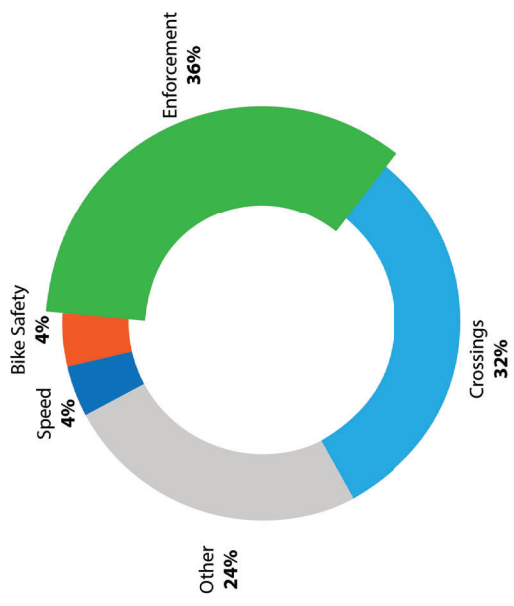

WHAT WE HEARD VISION ZERO TOP FIVE STUDY



Below is an overview of the community feedback comments received from events at each corridor, distributed into relevant categories.

Marysville

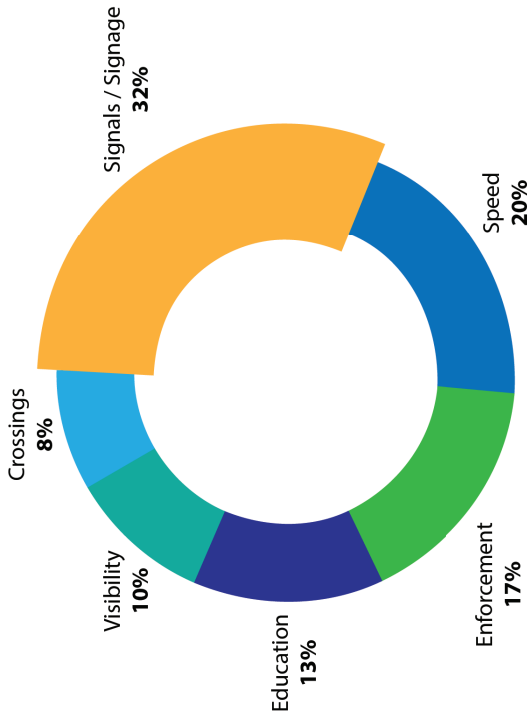

El Camino

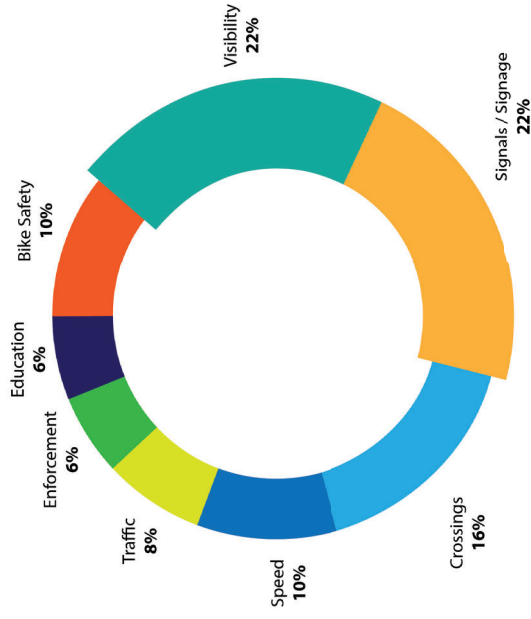

BROADWAY CORRIDOR-WIDE RECOMMENDATIONS



Distance Between Crosswalks
On-Street Bicycle Lane

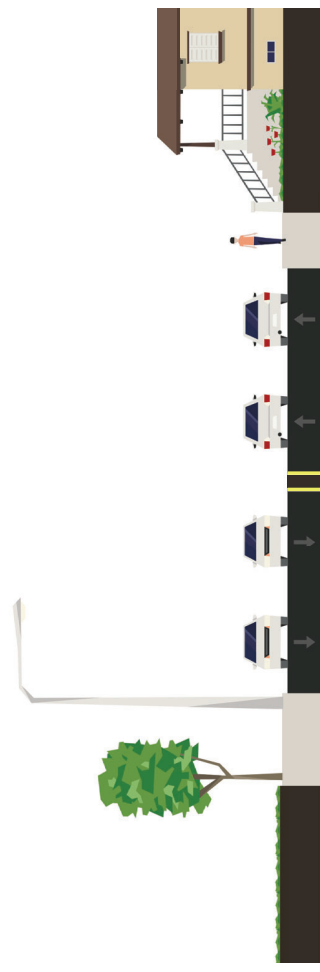

What You See Today

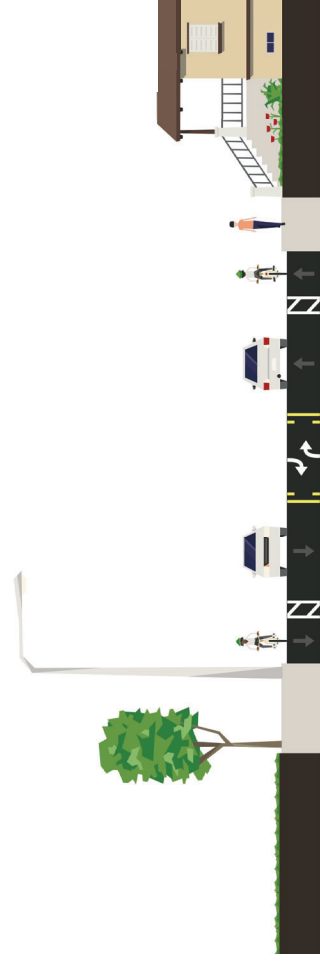

What's Proposed

Source: StreetMx (CC BY-SA 4.0, <https://creativecommons.org/licenses/by-sa/4.0/>)

Corridor-Wide Recommendations

- Road Diet
- Separated/Buffered Bicycle
- Advanced Dilemma-Zone Detection

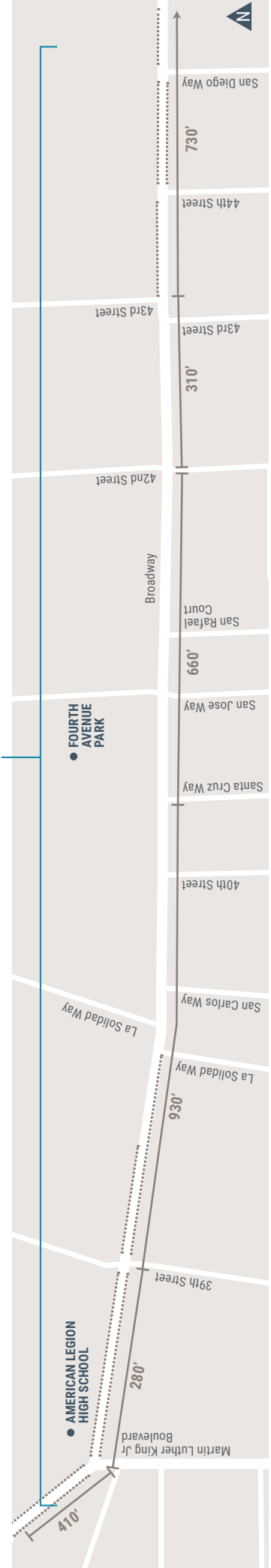

BROADWAY IMPROVEMENTS



S4 | 40%

Advanced Dilemma-Zone Detection

🔗 Signals/Signage

Advanced dilemma-zone detection enhances safety at signalized intersections by modifying traffic control signal timing on the fly to reduce the number of drivers that may have difficulty deciding whether to stop or proceed during a yellow phase. This may reduce rear-end crashes associated with unsafe stopping and angle crashes due to red light running.



Consolidate Driveways

🔗 Bike Safety, Pedestrian Safety, Visibility

Reducing the number of driveway entrances/exits through consolidation limits the exposure of bicyclists, pedestrians, and drivers to vehicles entering or exiting driveways, reducing conflicts.



MSG/NS17/NS18 | 25-35%

High Visibility Crosswalk

🔗 Crossings, Pedestrian Safety, Visibility

A crosswalk designed to be more visible to approaching drivers, striped with ladder markings using high-visibility material such as thermoplastic tape instead of paint.



NS3 | 25%

New Traffic Signal

🔗 Signals/Signage

New traffic signals help organize travel of all modes at an intersection, limiting interactions between vehicles, pedestrians, and bicyclists with conflicting movements. New signals can have a traffic calming effect on long, high-speed straightaways.



RT5 | 30%

Road Diet

🔗 Speed, Pedestrian Safety, Bike Safety, Crossings

Road diets generally reassign space in the roadway from vehicle travel lanes to create room for bicycle facilities, wider sidewalks, or center turn lanes. Road diets optimize street space to benefit all users by improving the safety and comfort of pedestrians and bicyclists, and reducing vehicle speeds and the potential for rear end collisions.



R36 | 35%

Separated/Buffered Bikeway

🔗 Bike Safety

Designated bicycle lanes, separated from vehicle traffic by a physical barrier, usually bollards, landscaping, or parked cars. These facilities can increase safety by decreasing opportunities for collisions with overtaking vehicles, and reducing the risk of dooring.

BROADWAY RECOMMENDATIONS



XXX

Distance Between Crosswalks
On-Street Bicycle Lane

Location-Specific Recommendations

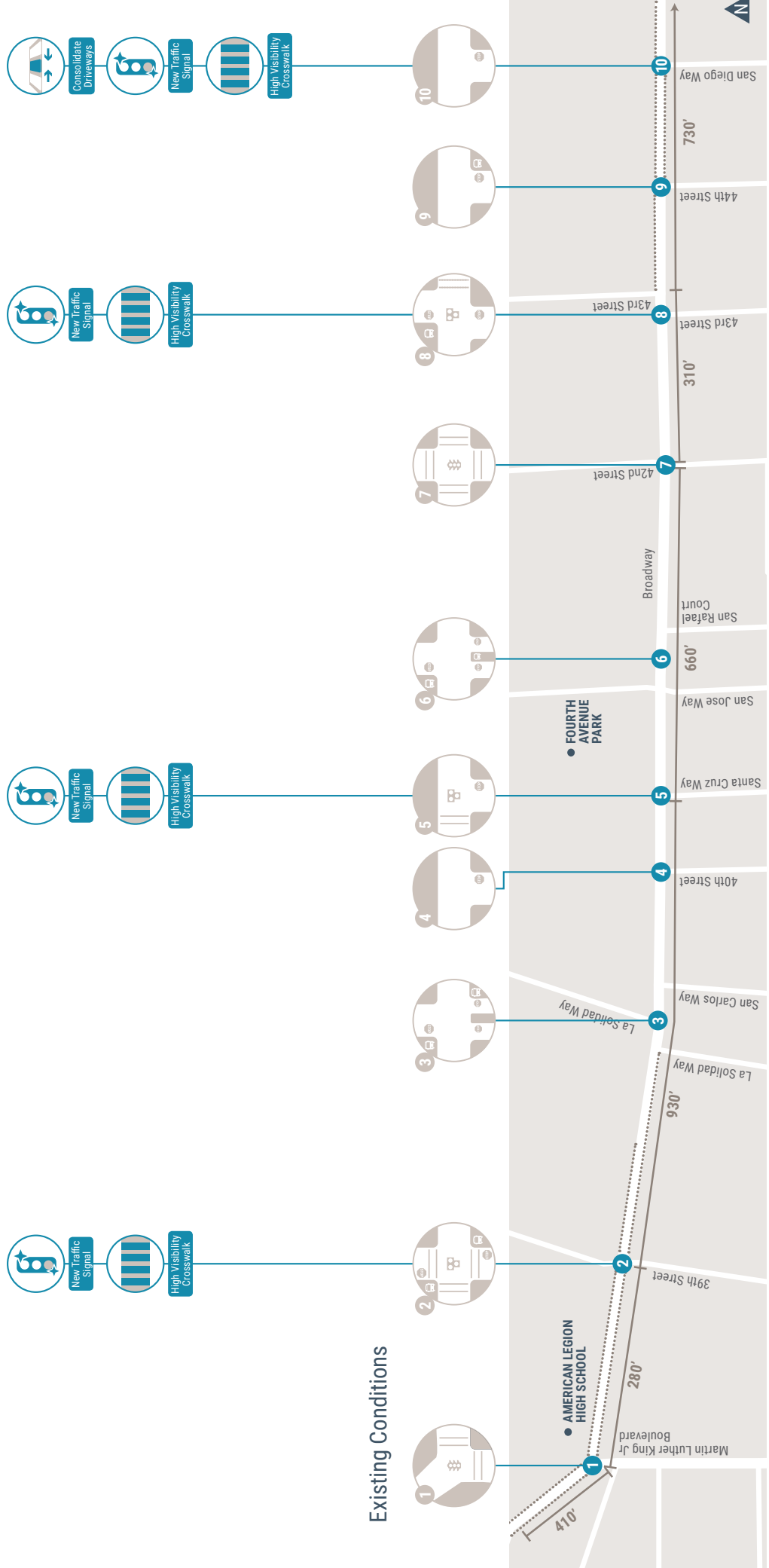

NORTH STOCKTON BOULEVARD CORRIDOR-WIDE RECOMMENDATIONS

SPEED
LIMIT
35

Distance Between Crosswalks
On-Street Bicycle Lane

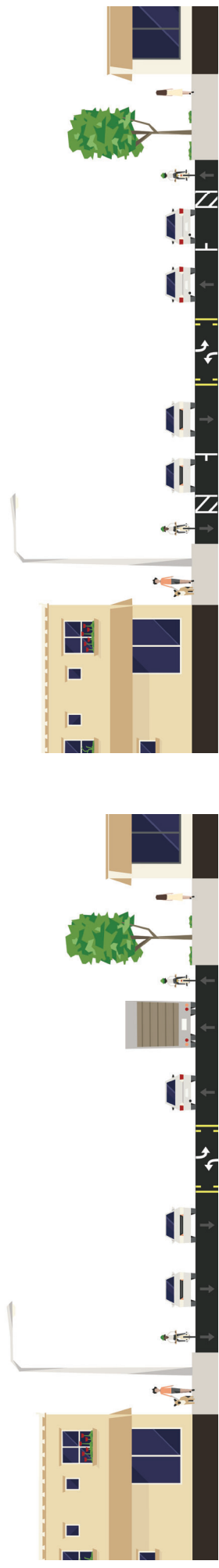

What You See Today

What's Proposed

Source: StreetMik (CC BY-SA 4.0, <https://creativecommons.org/licenses/by-sa/4.0/>)

Corridor-Wide Recommendations

- Road Diet
- Separated/Buffered Bikeway
- Bus Boarding Islands
- Advanced Dilemma-Zone Detection

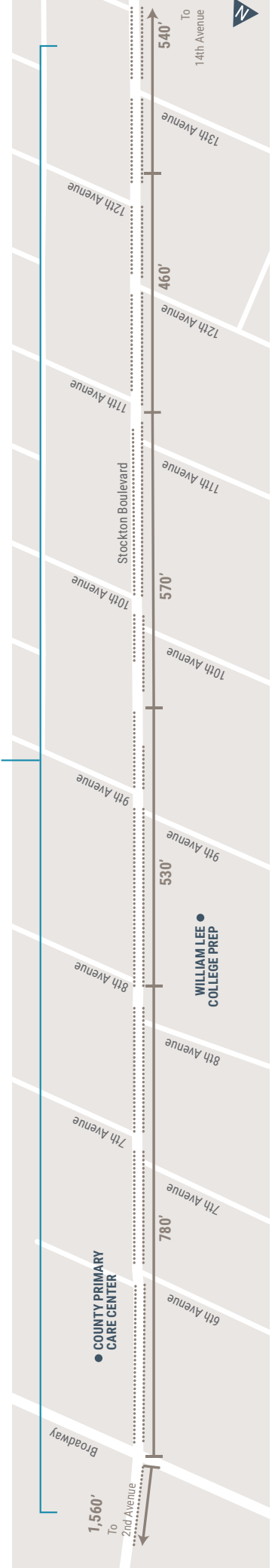

NORTH STOCKTON BOULEVARD IMPROVEMENTS



S4 40%

Advanced Dilemma-Zone Detection

🔗 Signals/Signage

Advanced dilemma-zone detection enhances safety at signalized intersections by modifying traffic control signal timing on the fly to reduce the number of drivers that may have difficulty deciding whether to stop or proceed during a yellow phase. This may reduce rear-end crashes associated with unsafe stopping and angle crashes due to red light running.



Bus Boarding Islands

🔗 Bike Safety

Dedicated waiting and boarding areas for passengers that are separated from the sidewalk by a bike channel, eliminating conflicts between transit vehicles and bikes at stops.



R36 35%

Close Bike Lane Gap

🔗 Bike Safety

Closing gaps between bicycle lanes increases the amount of dedicated facilities bicyclists can use, reducing mixing of bicyclists and drivers and increasing network connectivity and visibility of bicyclists in the roadway.



Consolidate Driveways

🔗 Bike Safety, Pedestrian

Reducing the number of driveway entrances/exits through consolidation limits the exposure of bicyclists, pedestrians, and drivers to vehicles entering or exiting driveways, reducing conflicts.



Dual Curb Ramps

🔗 Pedestrian Safety

Dual curb ramps improve ADA accessibility at all intersection approaches so that pedestrians with mobility challenges, or those pushing carts or strollers, can safely enter and exit all crosswalks.



S3 15%

Extend Pedestrian Crossing Time

🔗 Crossings, Pedestrian Safety

Increases time for pedestrian walk phases, and can better accommodate vulnerable populations such as children and the elderly.



S3 15%

Extend Signal Clearance Time

🔗 Signals/Signage

Extending yellow and all red time allows drivers and bicyclists to safely cross through a signalized intersection before conflicting traffic movements are permitted to enter the intersection.



NS6/NS17/NS18 25-35%

High Visibility Crosswalk

🔗 Crossings, Pedestrian Safety, Visibility

A crosswalk designed to be more visible to approaching drivers, striped with ladder markings using high-visibility material such as thermoplastic tape instead of paint.



Intersection Tightening

🔗 Crossings, Pedestrian Safety, Speed, Visibility

Uses temporary materials like paint, plastic bollards, and reflective markers to visually and physically narrow the street at intersections, which can create a shorter crossing for pedestrians and slows vehicles approaching the intersection and turning.



S5 59%

Leading Pedestrian Interval

🔗 Crossings, Pedestrian Safety, Visibility

Traffic signals timed to allow pedestrians a short head start in crossing an intersection to minimize conflicts with turning vehicles and improve pedestrian visibility.



NS3 25%

New Traffic Signal

🔗 Signals/Signage

New traffic signals help organize travel of all modes at an intersection, limiting interactions between vehicles, pedestrians, and bicyclists with conflicting movements. New signals can have a traffic calming effect on long, high-speed straightaways.



S3 35%

Pedestrian Scramble

🔗 Crossings, Pedestrian Safety, Signals/Signage

Restricts vehicular movements to provide an exclusive signal phase allowing pedestrians to cross in all directions, including diagonally.



S10 10%

Prohibit Left Turn

🔗 Bike Safety, Crossings, Pedestrian Safety, Signals/Signage

Bans left turns at locations where a turning vehicle may conflict with pedestrians in the crosswalk or where opposing traffic volume is high. Reduces pedestrian interaction with vehicles when crossing.



S13/NS12/R9 25% - 45%

Raised Median

🔗 Crossings, Pedestrian Safety, Speed

Curbed sections in the center of the roadway that are physically separated from vehicular traffic. Raised medians can also help control access to and from side streets and driveways, reducing conflict points.



Red Light Camera

🔗 Signals/Signage

Red light cameras can be used for automated enforcement to issue citations to drivers running red lights at signalized intersections, and may discourage this behavior.

NORTH STOCKTON BOULEVARD IMPROVEMENTS



Relocate Crosswalk

📌 Crossings, Pedestrian Safety, Visibility

Relocating existing crosswalks can help improve pedestrian visibility, shorten crossing distances, and minimize conflicts with vehicles. In some cases, crosswalks currently located between two legs of an offset intersection may be moved to the far side of the intersection to minimize the number of conflicting vehicle turning movements.



Road Diet

📌 Speed, Pedestrian Safety, Bike Safety, Crossings

Road diets generally reassign space in the roadway from vehicle travel lanes to create room for bicycle facilities, wider sidewalks, or center turn lanes. Road diets optimize street space to benefit all users by improving the safety and comfort of pedestrians and bicyclists, and reducing vehicle speeds and the potential for rear end collisions.



Separated/Buffered Bikeway

📌 Bike Safety

Designated bicycle lanes, separated from vehicle traffic by a physical barrier, usually bollards, landscaping, or parked cars. These facilities can increase safety by decreasing opportunities for collisions with over-taking vehicles, and reducing the risk of dooring.



Shorten Signal Cycle Length

📌 Signals/Signage

Reducing the cycle length at intersections may reduce the delay experienced by vehicles, bicyclists, and pedestrians. When delay is significant, road users are more inclined to ignore signal indications.

NORTH STOCKTON BOULEVARD RECOMMENDATIONS

SPEED
LIMIT
35

XXX

Distance Between Crosswalks
..... On-Street Bicycle Lane

Location-Specific Recommendations

- Pedestrian Scramble
- Shorten Signal Cycle Length
- Extend Signal Clearance Time
- Red Light Camera
- Extend Pedestrian Crossing Time
- Consolidate Driveways
- Intersection Tightening
- Dual Curb Ramps
- High Visibility Crosswalk
- Prohibit Left Turn
- New Traffic Signal
- High Visibility Crosswalk

Existing Conditions

- Raised Median
- Leading Pedestrian Interval

- High Visibility Crosswalk
- Relocate Crosswalk
- High Visibility Crosswalk
- Close Bike Lane Gap

- Relocate Crosswalk
- High Visibility Crosswalk
- New Traffic Signal
- High Visibility Crosswalk

- Pedestrian Scramble
- Shorten Signal Cycle Length
- Extend Signal Clearance Time
- Red Light Camera
- Extend Pedestrian Crossing Time
- Consolidate Driveways
- Intersection Tightening
- Dual Curb Ramps
- High Visibility Crosswalk
- Prohibit Left Turn
- New Traffic Signal
- High Visibility Crosswalk

- High Visibility Crosswalk
- Close Bike Lane Gap

- Relocate Crosswalk
- High Visibility Crosswalk

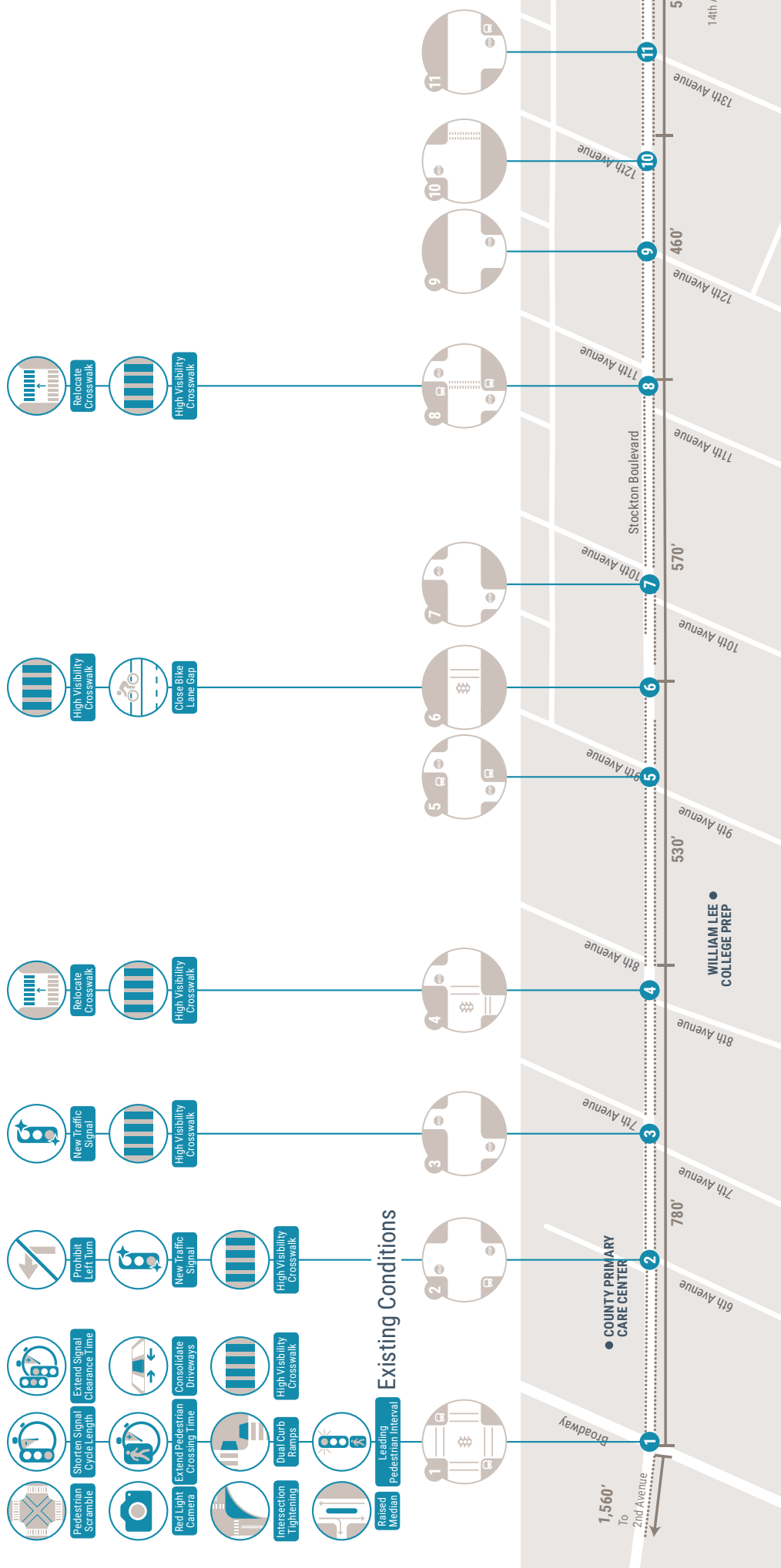

SOUTH STOCKTON BOULEVARD CORRIDOR-WIDE RECOMMENDATIONS

SPEED
LIMIT
40

XXX

Distance Between Crosswalks
On-Street Bicycle Lane



What You See Today

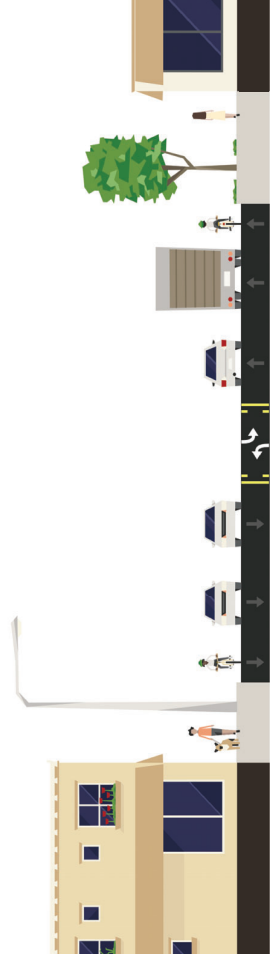

What's Proposed

Source: StreetMix (CC BY-SA 4.0, <https://creativecommons.org/licenses/by-sa/4.0/>)

Corridor-Wide Recommendations

- Pedestrian Scale Lighting
- Slow Green Wave
- Shorten Signal Cycle Length
- Extend Signal Clearance Time
- Advanced Dilemma-Zone Detection

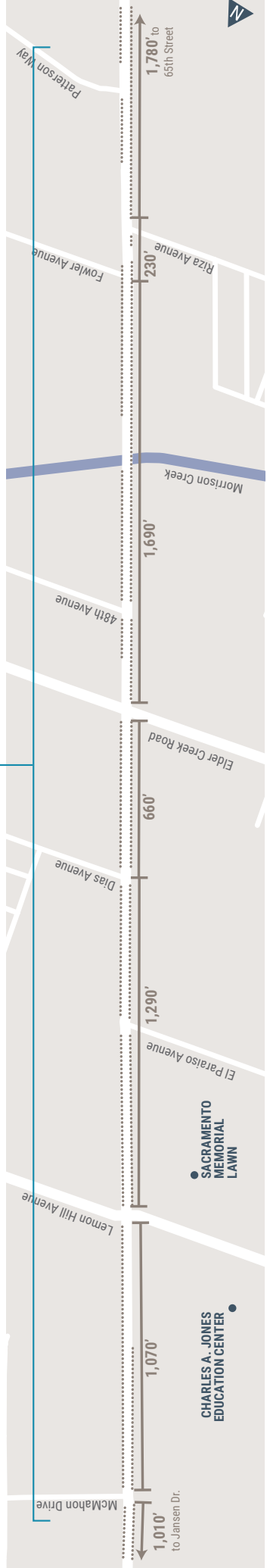

SOUTH STOCKTON BOULEVARD IMPROVEMENTS



S4 40%

Advanced Dilemma-Zone Detection

🔗 Signals/Signage

Advanced dilemma-zone detection enhances safety at signalized intersections by modifying traffic control signal timing on the fly to reduce the number of drivers that may have difficulty deciding whether to stop or proceed during a yellow phase. This may reduce rear-end crashes associated with unsafe stopping and angle crashes due to red light running.



SZ1 15%

Advance Stop Bar

🔗 Crossings, Pedestrian Safety

A stop bar placed ahead of the crosswalk at stop signs and signals reduces instances of vehicles encroaching on the crosswalk.



Bicycle Conflict Zone Markings

🔗 Bike Safety

Green pavement within a bicycle lane to increase visibility of bicyclists and to reinforce bicycle priority. The green pavement is used as a spot treatment in conflict areas such as driveways.



Consolidate Driveways

🔗 Bike Safety, Pedestrian Safety, Visibility

Reducing the number of driveway entrances/exits through consolidation limits the exposure of bicyclists, pedestrians, and drivers to vehicles entering or exiting driveways, reducing conflicts.



ST9 25%

Countdown Pedestrian Signal Heads

🔗 Crossings, Pedestrian Safety, Signals/Signage

Displays "countdown" of seconds remaining on the pedestrian signal. Countdown indications improve safety for all road users, and are required for all newly installed traffic signals where pedestrian signals are installed.



Dual Curb Ramps

🔗 Pedestrian Safety

Dual curb ramps improve ADA accessibility at all intersection approaches so that pedestrians with mobility challenges, or those pushing carts or strollers, can safely enter and exit all crosswalks.



Extend Bike Lane to Intersection

🔗 Bike Safety

In locations where a bike lane is dropped due to the addition of a right turn pocket, the intersection approach may be restriped to allow for bicyclists to move to the left side of right-turning vehicles ahead of reaching the intersection.



S3 15%

Extend Pedestrian Crossing Time

🔗 Crossings, Pedestrian Safety

Increases time for pedestrian walk phases, and can better accommodate vulnerable populations such as children and the elderly.



S3 15%

Extend Signal Clearance Time

🔗 Signals/Signage

Extending yellow and all red time allows drivers and bicyclists to safely cross through a signalized intersection before conflicting traffic movements are permitted to enter the intersection.



NS6/NS7/NS10 25-35%

High Visibility Crosswalk

🔗 Crossings, Pedestrian Safety, Visibility

A crosswalk designed to be more visible to approaching drivers, striped with ladder markings using high-visibility material such as thermoplastic tape instead of paint.



Intersection Tightening

🔗 Crossings, Pedestrian Safety, Speed, Visibility

Uses temporary materials like paint, plastic bollards, and reflective markers to visually and physically narrow the street at intersections, which can create a shorter crossing for pedestrians and slows vehicles approaching the intersection and turning.



59%

Leading Pedestrian Interval

🔗 Crossings, Pedestrian Safety, Visibility

Traffic signals timed to allow pedestrians a short head start in crossing an intersection to minimize conflicts with turning vehicles and improve pedestrian visibility.



ST12/NS116 25-45%

Pedestrian Refuge Island

🔗 Crossings, Pedestrian Safety, Speed, Visibility

Pedestrian refuge islands provide a protected area for pedestrians at the center of the roadway. They reduce the exposure time for pedestrians crossing the intersection and simplify crossings by allowing pedestrians to focus on one direction of traffic at a time.



ST/NS1/RT1 35-40%

Pedestrian Scale Lighting

🔗 Crossings, Pedestrian Safety, Visibility

Appropriate quality and placement of lighting can enhance an environment as well as increase comfort and safety. Pedestrian-scale lighting is lower in height than standard streetlighting and is spaced closer together.



Prohibit Turn During Pedestrian Phase

🔗 Bike Safety, Crossings, Pedestrian Safety, Signals/Signage

Restricts left or right turns during the pedestrian crossing phase at locations where a turning vehicle may conflict with pedestrians in the crosswalk. This restriction may be displayed with a blank-out sign.

SOUTH STOCKTON BOULEVARD IMPROVEMENTS



S3 15%

Provide Green Time For Bikes

🔗 Bike Safety, Signals/Signage

Provide or prolong the green phase when bicyclists are present to provide additional time for bicyclist to clear the intersection. Can occur automatically in the signal phasing or when prompted with bicycle detection. Topography should be considered in clearance time.



S13/NS12/R9 25% - 45%

Raised Median

🔗 Crossings, Pedestrian Safety, Speed

Curbed sections in the center of the roadway that are physically separated from vehicular traffic. Raised medians can also help control access to and from side streets and driveways, reducing conflict points.



Remove Dual Left Turn Lanes

🔗 Signals/Signage

Restriping an approach so there is a single left-turn lane instead of dual lefts can help simplify an intersection and create room for a road diet or other geometric improvements.



Remove Right Turn Slip Lane

🔗 Bike Safety, Pedestrian Safety, Speed

Closing a free-flow right-turn slip lane can help slow right turning drivers, eliminates an uncontrolled crossing for pedestrians, and shortens pedestrian crossing distances. The space reclaimed in closing the slip lane can be reused as pedestrian space to widen sidewalks, enhance curb ramps, or provide more space for street furniture.



NS10 20%

Remove Sight Obstruction

🔗 Visibility

Remove objects that may prevent drivers and pedestrians from having a clear sightline. May include trimming or removing landscaping, or removing or relocating large signs.



S3 15%

Shorten Signal Cycle Length

🔗 Signals/Signage

Reducing the cycle length at intersections may reduce the delay experienced by vehicles, bicyclists, and pedestrians. When delay is significant, road users are more inclined to ignore signal indications.



Stop Sign

🔗 Signals/Signage

When warranted, stop signs provide a cue to drivers to stop and wait for vehicles, bicyclists, and pedestrians to cross before proceeding.



Slow Green Wave

🔗 Signals/Signage, Speed

A series of traffic signals coordinated to allow for uninterrupted bicycle traffic flow or slower vehicle travel speeds through several intersections along a corridor. Coordinating signals for a slower travel speed gives bicyclists more time to cross safely and encourages drivers to travel at slower speeds.

FLORIN ROAD CORRIDOR-WIDE RECOMMENDATIONS

SPEED
LIMIT
40

XXX

Distance Between Crosswalks
On-Street Bicycle Lane

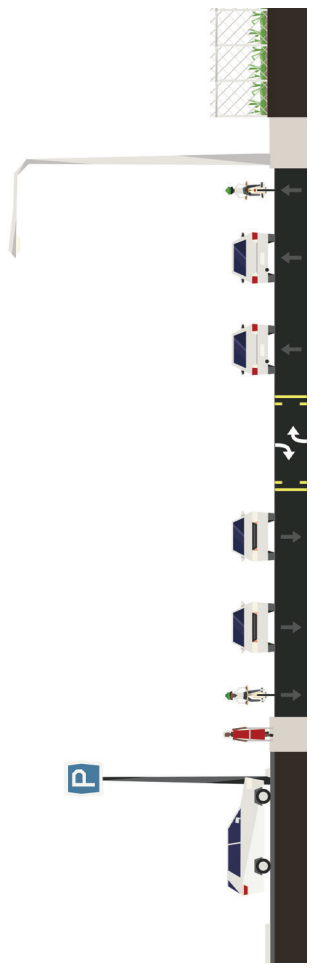



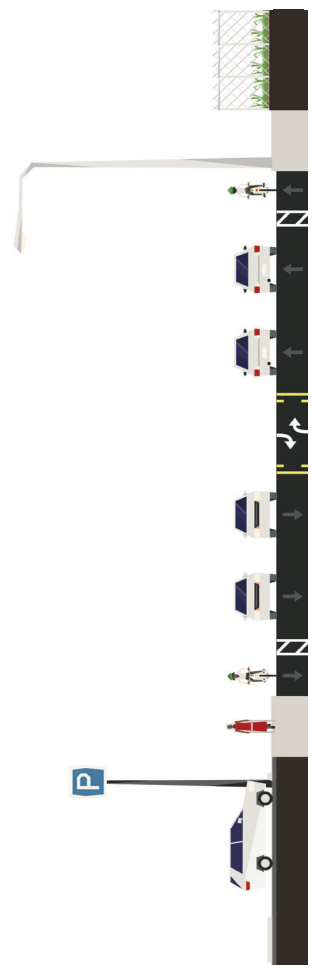







What You See Today



What's Proposed

Source: StreetMx (CC BY-SA 4.0). <https://streetmxccommons.org/licenses/by-sa/4.0/>

Corridor-Wide Recommendations

-  Narrow Lanes
-  Separated/Buffered Bikeway
-  Pedestrian Scale Lighting
-  Consolidate Driveways
-  Widen Sidewalk
-  Landscape Buffer
-  Slow Green Wave
-  Bicycle Conflict Zone Markings
-  Protected Left Turns
-  Advanced Dilemma-Zone Detection



FLORIN ROAD IMPROVEMENTS



S4 | 40%

Advanced Dilemma-Zone Detection

🔗 Signals/Signage

Advanced dilemma-zone detection enhances safety at signalized intersections by modifying traffic control signal timing on the fly to reduce the number of drivers that may have difficulty deciding whether to stop or proceed during a yellow phase. This may reduce rear-end crashes associated with unsafe stopping and angle crashes due to red light running.



Bike Safety

Bicycle Conflict Zone Markings

Green pavement within a bicycle lane to increase visibility of bicyclists and to reinforce bicycle priority. The green pavement is used as a spot treatment in conflict areas such as driveways.



Crossings, Pedestrian Safety, Speed, Visibility

Bulbout

Raised devices, usually constructed from concrete, landscaping, or paint and plastic materials, that narrow the roadway to reduce speeds of turning vehicles, improve sight lines, and shorten pedestrian crossing distances.



R336 | 35%

Close Bike Lane Gap

🔗 Bike Safety

Closing gaps between bicycle lanes increases the amount of dedicated facilities bicyclists can use, reducing mixing of bicyclists and drivers and increasing network connectivity and visibility of bicyclists in the roadway.



Consolidate Driveways

🔗 Bike Safety, Pedestrian Safety, Visibility

Reducing the number of driveway entrances/exits through consolidation limits the exposure of bicyclists, pedestrians, and drivers to vehicles entering or exiting driveways, reducing conflicts.



Pedestrian Safety

Dual Curb Ramps

Dual curb ramps improve ADA accessibility at all intersection approaches so that pedestrians with mobility challenges, or those pushing carts or strollers, can safely enter and exit all crosswalks.



S3 | 15%

Extend Pedestrian Crossing Time

🔗 Crossings, Pedestrian Safety

Increases time for pedestrian walk phases, and can better accommodate vulnerable populations such as children and the elderly.



S3 | 15%

Extend Signal Clearance Time

🔗 Signals/Signage

Extending yellow and all red time allows drivers and bicyclists to safely cross through a signalized intersection before conflicting traffic movements are permitted to enter the intersection.



NS6/NS7/NS18 | 25-35%

High Visibility Crosswalk

🔗 Crossings, Pedestrian Safety, Visibility

A crosswalk designed to be more visible to approaching drivers, striped with ladder markings using high-visibility material such as thermoplastic tape instead of paint.



Landscape Buffer

🔗 Pedestrian Safety

Separating drivers from bicyclists and pedestrians using landscaping provides more space between the modes and can produce a traffic calming effect by encouraging drivers to drive at slower speeds, lowering the risk of collision.



59%

Leading Pedestrian Interval

🔗 Crossings, Pedestrian Safety, Visibility

Traffic signals timed to allow pedestrians a short head start in crossing an intersection to minimize conflicts with turning vehicles and improve pedestrian visibility.



R3 | 25%

Median Barrier Fencing

🔗 Crossings, Pedestrian Safety

Pedestrian median barriers restrict pedestrians from crossing the median at locations where nearby crossings are available and midblock crossings may have poor sight lines or insufficient safety enhancements for the conditions.



Narrow Lanes

🔗 Speed

A reduction in lane width, to 11 feet, produces a traffic calming effect by encouraging drivers to travel at slower speeds, lowering the risk of collision with bicyclists, pedestrians, and other drivers.



NS3 | 25%

New Traffic Signal

🔗 Signals/Signage

New traffic signals help organize travel of all modes at an intersection, limiting interactions between vehicles, pedestrians, and bicyclists with conflicting movements. New signals can have a traffic calming effect on long, high-speed straightaways.



S12/NS16 | 25-45%

Pedestrian Refuge Island

🔗 Crossings, Pedestrian Safety, Speed, Visibility

Pedestrian refuge islands provide a protected area for pedestrians at the center of the roadway. They reduce the exposure time for pedestrians crossing the intersection and simplify crossings by allowing pedestrians to focus on one direction of traffic at a time.

FLORIN ROAD IMPROVEMENTS



ST/NSI/TR1 35-40%

Pedestrian Scale Lighting

Crossings, Pedestrian Safety, Visibility

Appropriate quality and placement of lighting can enhance an environment as well as increase comfort and safety. Pedestrian-scale lighting is lower in height than standard streetlighting and is spaced closer together.



Prohibit Turn During Pedestrian Phase

Bike Safety, Crossings, Pedestrian Safety, Signals/Signage

Restricts left or right turns during the pedestrian crossing phase at locations where a turning vehicle may conflict with pedestrians in the crosswalk. This restriction may be displayed with a blank-out sign.



S6/S17 30-55%

Protected Left Turns

Signals/Signage

Protected left turns provide an exclusive phase for left-turning vehicles to enter an intersection separate from conflicting vehicle or pedestrian movements.



S13/NS12/R9 25-45%

Raised Median

Crossings, Pedestrian Safety, Speed

Curbed sections in the center of the roadway that are physically separated from vehicular traffic. Raised medians can also help control access to and from side streets and driveways, reducing conflict points.



R36 35%

Separated/Buffered Bikeway

Bike Safety

Wide sidewalks can provide a more comfortable space for pedestrians. They are particularly helpful at important for locations with high volumes of pedestrians, and for providing space to accommodate people in wheelchairs.



Slow Green Wave

Signals/Signage, Speed

A series of traffic signals coordinated to allow for uninterrupted bicycle traffic flow or slower vehicle travel speeds through several intersections along a corridor. Coordinating signals for a slower travel speed gives bicyclists more time to cross safely and encourages drivers to travel at slower speeds.



Straighten Crosswalk

Crossings, Pedestrian Safety, Visibility

Straightening crosswalks improves sight lines, making pedestrians more visible to oncoming drivers, and may shorten the crossing distance, reducing the length of time required for pedestrians to cross an intersection.



Widen Sidewalk

Pedestrian Safety

Wide sidewalks can provide a more comfortable space for pedestrians. They are particularly helpful at important for locations with high volumes of pedestrians, and for providing space to accommodate people in wheelchairs.

FLORIN ROAD RECOMMENDATIONS

SPEED LIMIT
40

XXX

Distance Between Crosswalks
On-Street Bicycle Lane

Location-Specific Recommendations

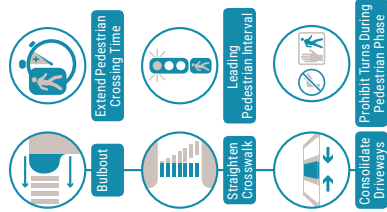

MARYSVILLE BOULEVARD CORRIDOR-WIDE RECOMMENDATIONS

35
SPEED
LIMIT

XXX

Distance Between Crosswalks
On-Street Bicycle Lane

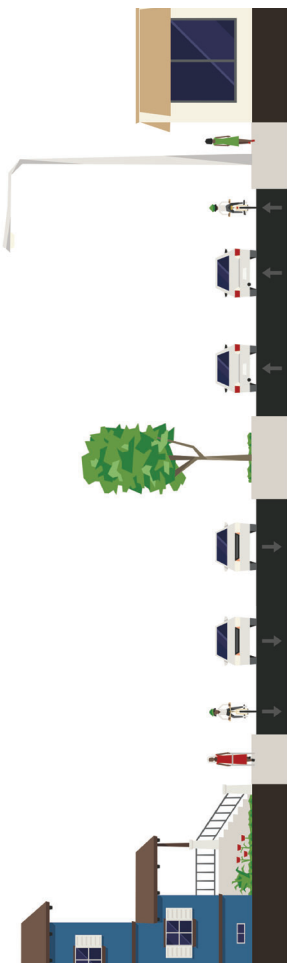

What You See Today

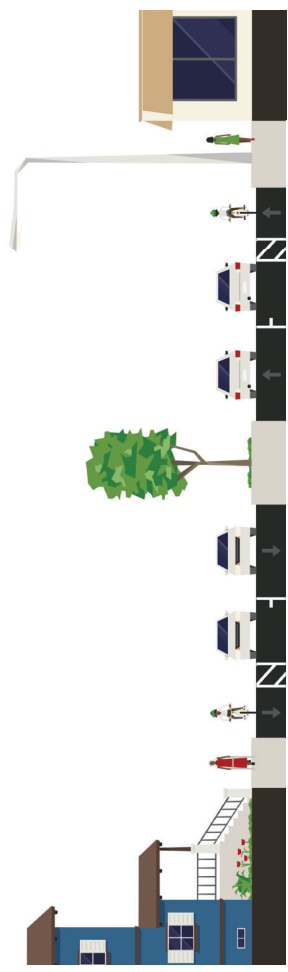

What's Proposed

Source: StreetMik (CC BY-SA 4.0, <https://creativecommons.org/licenses/by-sa/4.0/>)

Corridor-Wide Recommendations

- 

Extend Signal Clearance Time
- 

Slow Green Wave
- 

Road Diet
- 

Separated/Buffered Bikeway
- 

Advanced Dilemma-Zone Detection

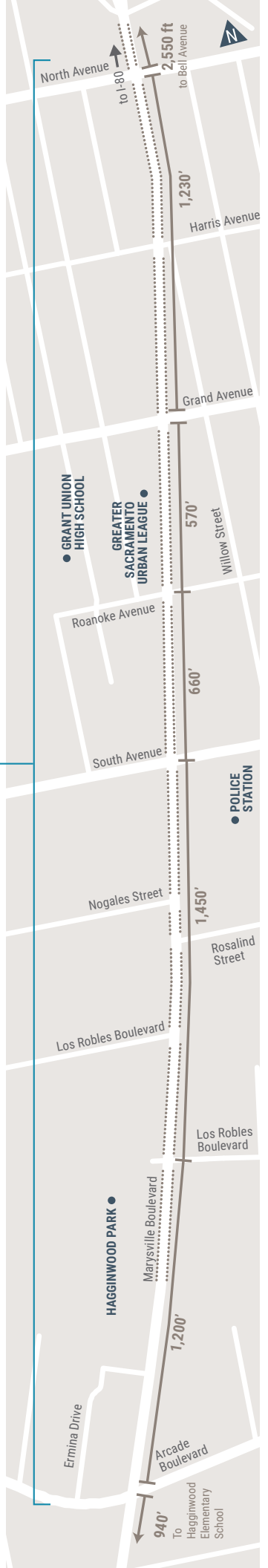

MARYSVILLE BOULEVARD IMPROVEMENTS



S4 | 40%

Advanced Dilemma-Zone Detection

🔗 Signals/Signage

Advanced dilemma-zone detection enhances safety at signalized intersections by modifying traffic control signal timing on the fly to reduce the number of drivers that may have difficulty deciding whether to stop or proceed during a yellow phase. This may reduce rear-end crashes associated with unsafe stopping and angle crashes due to red light running.



S21 | 15%

Advance Stop Bar

🔗 Crossings, Pedestrian Safety

A stop bar placed ahead of the crosswalk at stop signs and signals reduces instances of vehicles encroaching on the crosswalk.



R36 | 35%

Class II Bicycle Lane

🔗 Bike Safety

Five to seven foot wide designated lanes for bicyclist adjacent to vehicle travel lanes, delineated with pavement markings.



R36 | 35%

Close Bike Lane Gap

🔗 Bike Safety

Closing gaps between bicycle lanes increases the amount of dedicated facilities bicyclists can use, reducing mixing of bicyclists and drivers and increasing network connectivity and visibility of bicyclists in the roadway.



Co-locate Bus Stops and Pedestrian Crossings

🔗 Crossings, Pedestrian Safety

Place bus stops and pedestrian crossings in close proximity to allow transit riders to cross the street safely.



🔗 Bike Safety, Pedestrian Safety, Visibility

Reducing the number of driveway entrances/exits through consolidation limits the exposure of bicyclists, pedestrians, and drivers to vehicles entering or exiting driveways, reducing conflicts.



S19 | 25%

Countdown Pedestrian Signal Heads

🔗 Crossings, Pedestrian Safety, Signals/Signage

Displays "countdown" of seconds remaining on the pedestrian signal. Countdown indications improve safety for all road users, and are required for all newly installed traffic signals where pedestrian signals are installed.



🔗 Bike Safety

In locations where a bike lane is dropped due to the addition of a right turn pocket, the intersection approach may be restriped to allow for bicyclists to move to the left side of right-turning vehicles ahead of reaching the intersection.



S3 | 15%

Extend Pedestrian Crossing Time

🔗 Crossings, Pedestrian Safety

Increases time for pedestrian walk phases, and can better accommodate vulnerable populations such as children and the elderly.



S3 | 15%

Extend Signal Clearance Time

🔗 Signals/Signage

Extending yellow and all red time allows drivers and bicyclists to safely cross through a signalized intersection before conflicting traffic movements are permitted to enter the intersection.



🔗 Crossings, Pedestrian Safety, Signals/Signage

Full pedestrian signals are full traffic signals, with red, amber and green indicators, that may be installed at mid-block locations. These signals provide a protected pedestrian crossing phase when the pedestrian phase is called, but otherwise rest in green for oncoming vehicles.



NS6/NS17/NS18 | 25-35%

High Visibility Crosswalk

🔗 Crossings, Pedestrian Safety, Visibility

A crosswalk designed to be more visible to approaching drivers, striped with ladder markings using high-visibility material such as thermoplastic tape instead of paint.



59%

Leading Pedestrian Interval

🔗 Crossings, Pedestrian Safety, Visibility

Traffic signals timed to allow pedestrians a short head start in crossing an intersection to minimize conflicts with turning vehicles and improve pedestrian visibility.



🔗 Speed

Narrow Lanes

A reduction in lane width, in 11 feet, produces a traffic calming effect by encouraging drivers to travel at slower speeds, lowering the risk of collision with bicyclists, pedestrians, and other drivers.



NS3 | 25%

New Traffic Signal

🔗 Signals/Signage

New traffic signals help organize travel of all modes at an intersection, limiting interactions between vehicles, pedestrians, and bicyclists with conflicting movements. New signals can have a traffic calming effect on long, high-speed straightaways.

MARYSVILLE BOULEVARD IMPROVEMENTS



Parking Prohibition

[Bike Safety](#), [Crossings](#), [Pedestrian Safety](#), [Signals/Signage](#)

By restricting parking at curbs in front of intersection crosswalks, sight lines are cleared between pedestrian crossings and oncoming drivers, reducing the risk of collision (also called "daylighting"). Parking can also be restricted in locations with on-street bicycle facilities to minimize dooring collisions.



Prohibit Turns During Pedestrian Phase

[Bike Safety](#), [Crossings](#), [Pedestrian Safety](#), [Signals/Signage](#)

Restricts left or right turns during the pedestrian crossing phase at locations where a turning vehicle may conflict with pedestrians in the crosswalk. This restriction may be displayed with a blank-out sign.



Protected Left Turns

[Signals/Signage](#)

Protected left turns provide an exclusive phase for left-turning vehicles to enter an intersection separate from conflicting vehicle or pedestrian movements.



Raised Median

[Crossings](#), [Pedestrian Safety](#), [Speed](#)

Curbed sections in the center of the roadway that are physically separated from vehicular traffic. Raised medians can also help control access to and from side streets and driveways, reducing conflict points.



Red Light Camera

[Signals/Signage](#)

Red light cameras can be used for automated enforcement to issue citations to drivers running red lights at signalized intersections, and may discourage this behavior.



Road Diet

[Speed](#), [Pedestrian Safety](#), [Bike Safety](#), [Crossings](#)

Road diets generally reassign space in the roadway from vehicle travel lanes to create room for bicycle facilities, wider sidewalks, or center turn lanes. Road diets optimize street space to benefit all users by improving the safety and comfort of pedestrians and bicyclists, and reducing vehicle speeds and the potential for rear end collisions.



Separated/Buffered Bikeway

[Bike Safety](#)

Designated bicycle lanes, separated from vehicle traffic by a physical barrier, usually bollards, landscaping, or parked cars. These facilities can increase safety by decreasing opportunities for collisions with over-taking vehicles, and reducing the risk of dooring.



Slow Green Wave

[Signals/Signage](#), [Speed](#)

A series of traffic signals coordinated to allow for uninterrupted bicycle traffic flow or slower vehicle travel speeds through several intersections along a corridor. Coordinating signals for a slower travel speed gives bicyclists more time to cross safely and encourages drivers to travel at slower speeds.



Split Signal Phase

[Signals/Signage](#)

Opposing legs of an intersection each receive their own phase



Straighten Crosswalk

[Crossings](#), [Pedestrian Safety](#), [Visibility](#)

Straightening crosswalks improves sight lines, making pedestrians more visible to oncoming drivers, and may shorten the crossing distance, reducing the length of time required for pedestrians to cross an intersection.

MARYSVILLE BOULEVARD RECOMMENDATIONS

SPEED LIMIT
35

XXX

Distance Between Crosswalks
On-Street Bicycle Lane

Location-Specific Recommendations

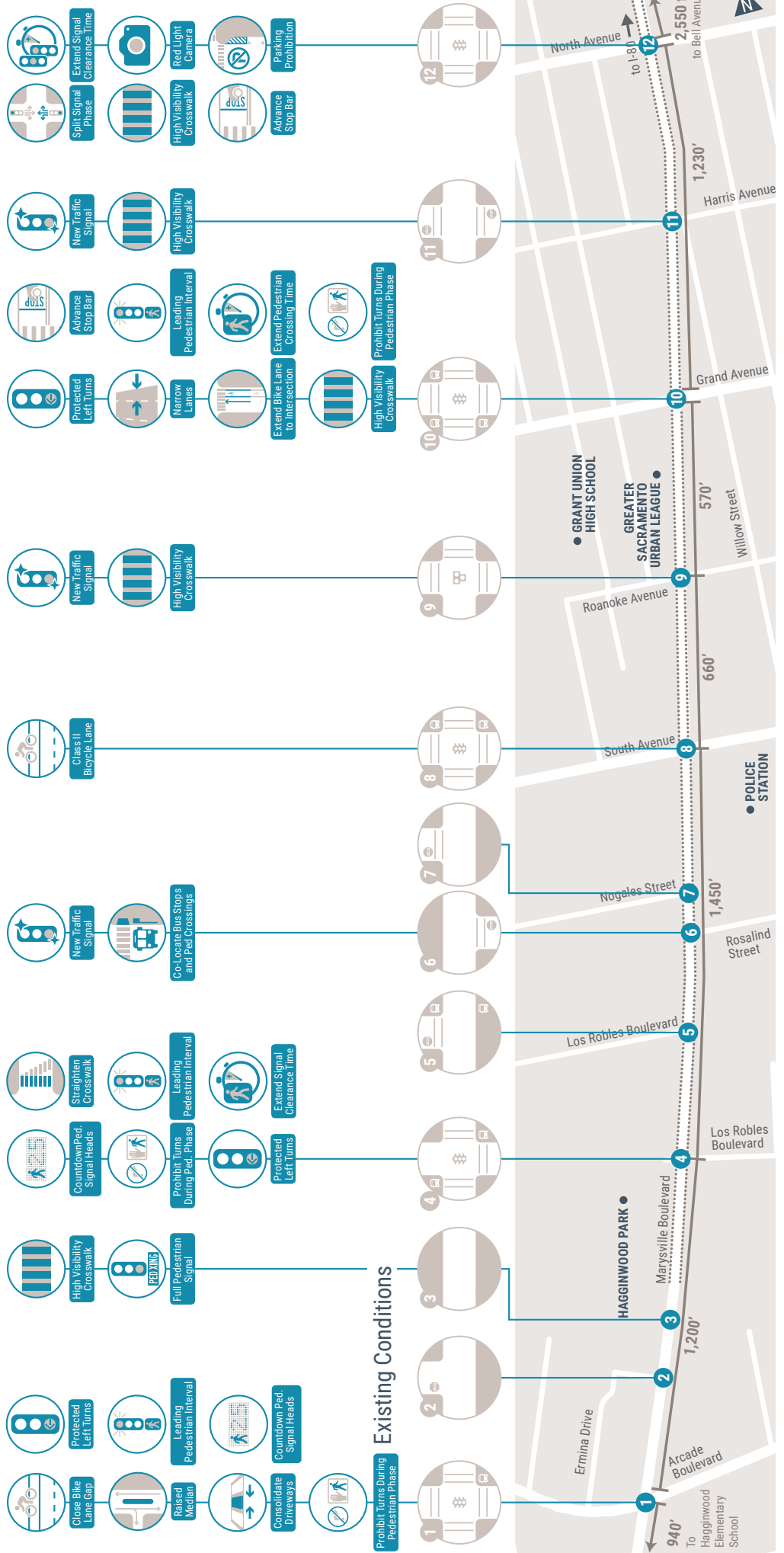

EL CAMINO AVENUE CORRIDOR-WIDE RECOMMENDATIONS

SPEED
LIMIT
30

Distance Between Crosswalks
On-Street Bicycle Lane

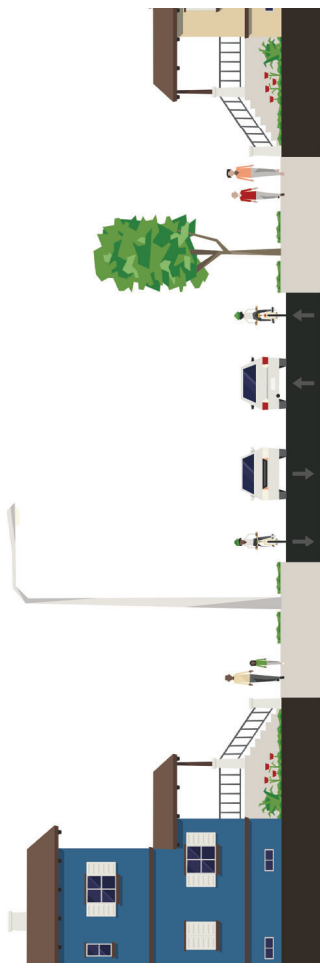

What You See Today

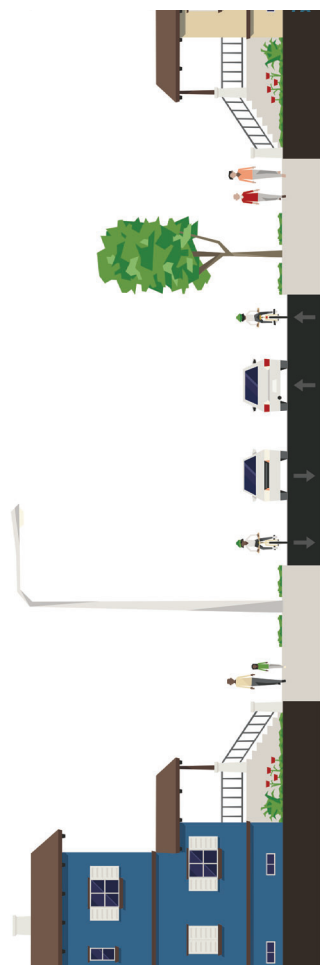

What's Proposed

Source: StreetMik (CC BY-SA 4.0, <https://creativecommons.org/licenses/by-sa/4.0/>)

Corridor-Wide Recommendations

- Pedestrian Scale Lighting
- Slow Green Wave
- Pedestrian Recall Signal Timing
- Advanced Dilemma-Zone Detection



EL CAMINO AVENUE IMPROVEMENTS



S4 | 40%

Advanced Dilemma-Zone Detection

🔗 Signals/Signage

Advanced dilemma-zone detection enhances safety at signalized intersections by modifying traffic control signal timing on the fly to reduce the number of drivers that may have difficulty deciding whether to stop or proceed during a yellow phase. This may reduce rear-end crashes associated with unsafe stopping and angle crashes due to red light running.



Bike Safety

Bicycle Conflict Zone Markings

Green pavement within a bicycle lane to increase visibility of bicyclists and to reinforce bicycle priority. The green pavement is used as a spot treatment in conflict areas such as driveways.



Crossings, Pedestrian Safety, Speed, Visibility

Bulbout

Raised devices, usually constructed from concrete, landscaping, or paint and plastic materials, that narrow the roadway to reduce speeds of turning vehicles, improve sight lines, and shorten pedestrian crossing distances.



R36 | 35%

Close Bike Lane Gap

Bike Safety

Closing gaps between bicycle lanes increases the amount of dedicated facilities bicyclists can use, reducing mixing of bicyclists and drivers and increasing network connectivity and visibility of bicyclists in the roadway.



R37 | 80%

Close Sidewalk Gap

Pedestrian Safety

Providing continuous sidewalks for pedestrians provides a separated facility for people to walk along the roadway, and can help minimize collisions with pedestrians walking in the road.



Consolidate Driveways

🔗 Bike Safety, Pedestrian Safety, Visibility

Reducing the number of driveway entrances/exits through consolidation limits the exposure of bicyclists, pedestrians, and drivers to vehicles entering or exiting driveways, reducing conflicts.



Dual Curb Ramps

Pedestrian Safety

Dual curb ramps improve ADA accessibility at all intersection approaches so that pedestrians with mobility challenges, or those pushing carts or strollers, can safely enter and exit all crosswalks.



S3 | 15%

Extend Signal Clearance Time

Signals/Signage

Extending yellow and all red time allows drivers and bicyclists to safely cross through a signalized intersection before conflicting traffic movements are permitted to enter the intersection.



NS6/NS7/NS18 | 25-35%

High Visibility Crosswalk

Crossings, Pedestrian Safety, Visibility

A crosswalk designed to be more visible to approaching drivers, striped with ladder markings using high-visibility material such as thermoplastic tape instead of paint.



NS3 | 25%

New Traffic Signal

Signals/Signage

New traffic signals help organize travel of all modes at an intersection, limiting interactions between vehicles, pedestrians, and bicyclists with conflicting movements. New signals can have a traffic calming effect on long, high-speed straightaways.



Partial Closure

🔗 Bike Safety, Crossings, Pedestrian Safety

Partial closures, using a physical barrier across one direction of traffic at an intersection allow full bicycle and pedestrian passage while restricting vehicle access in one direction. This strategy can be used to minimize conflict points at complicated intersections.



NS19 | 55%

Pedestrian Hybrid Beacon

Crossings, Pedestrian Safety, Signals/Signage, Speed, Visibility

Pedestrian-activated beacon used at mid-block crosswalks to notify oncoming motorists to stop with a series of red and yellow lights.



Pedestrian Recall Signal Timing

Pedestrian Safety, Signals/Signage

Signals can be put in "recall" for key time periods of the day such as peak business hours or school drop-off/pick-up times. The "WALK" signal would be displayed every signal cycle without prompting by a pedestrian push button.



S1/NS1/RT | 35-40%

Pedestrian Scale Lighting

Crossings, Pedestrian Safety, Visibility

Appropriate quality and placement of lighting can enhance an environment as well as increase comfort and safety. Pedestrian-scale lighting is lower in height than standard streetlighting and is spaced closer together.



35%

Pedestrian Scramble

Crossings, Pedestrian Safety, Signals/Signage

Restricts vehicular movements to provide an exclusive signal phase allowing pedestrians to cross in all directions, including diagonally.

EL CAMINO AVENUE IMPROVEMENTS



10%

Prohibit Left Turn

🔗 Bike Safety, Crossings, Pedestrian Safety, Signals/Signage

Bans left turns at locations where a turning vehicle may conflict with pedestrians in the crosswalk or where opposing traffic volume is high. Reduces pedestrian interaction with vehicles when crossing.



🔗 Crossings, Pedestrian Safety, Signals/Signage

Prohibit Turns During Pedestrian Phase

Restricts left or right turns during the pedestrian crossing phase at locations where a turning vehicle may conflict with pedestrians in the crosswalk. This restriction may be displayed with a blank-out sign.



S13/MS12/R9 | 25% - 45%

Raised Median

🔗 Crossings, Pedestrian Safety, Speed

Curbed sections in the center of the roadway that are physically separated from vehicular traffic. Raised medians can also help control access to and from side streets and driveways, reducing conflict points.



Realign Intersection to 90 Degrees

🔗 Crossings, Pedestrian Safety, Speed, Visibility

By eliminating acute or obtuse angles between intersection roadways, intersection sight distance may be improved, allowing drivers to see pedestrians more easily. Right-angle intersections can also help to slow down turning vehicles.



Road Closure

🔗 Bike Safety, Crossings, Pedestrian Safety

Road closures, using a physical barrier, allow full bicycle and pedestrian passage while restricting vehicle access. This strategy can be used to minimize conflict points at complicated intersections or to minimize conflicting movements due to turning vehicles.



S18 | 35-67%

Roundabout

🔗 Bike Safety, Pedestrian Safety, Signals/Signage

Roundabouts are large circular islands, placed in the middle of an intersection, which direct flow in a continuous circular direction around the intersection. Roundabouts can reduce the number of conflict points, compared to an uncontrolled intersection, and decrease vehicle speeds due to intersection geometry. Converting signalized intersections to roundabouts can be especially effective at complex intersections or intersections with high left-turn volumes.



S3 | 15%

Shorten Signal Cycle Length

🔗 Signals/Signage

Reducing the cycle length at intersections may reduce the delay experienced by vehicles, bicyclists, and pedestrians. When delay is significant, road users are more inclined to ignore signal indications.



Slow Green Wave

🔗 Signals/Signage, Speed

A series of traffic signals coordinated to allow for uninterrupted bicycle traffic flow or slower vehicle travel speeds through several intersections along a corridor. Coordinating signals for a slower travel speed gives bicyclists more time to cross safely and encourages drivers to travel at slower speeds.



Straighten Crosswalk

🔗 Crossings, Pedestrian Safety, Visibility

Straightening crosswalks improves sight lines, making pedestrians more visible to oncoming drivers, and may shorten the crossing distance, reducing the length of time required for pedestrians to cross an intersection.

EL CAMINO AVENUE RECOMMENDATIONS

SPEED
LIMIT
30

XXX

Distance Between Crosswalks
On-Street Bicycle Lane

Location-Specific Recommendations

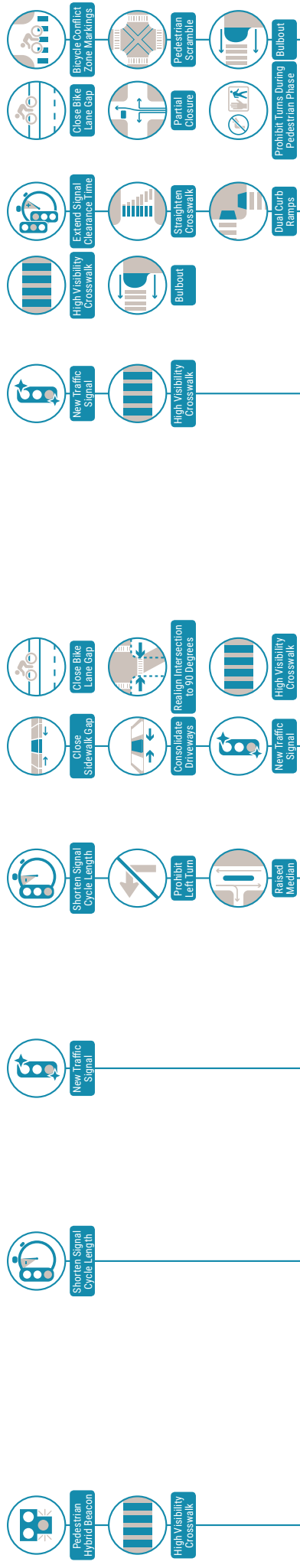

Existing Conditions

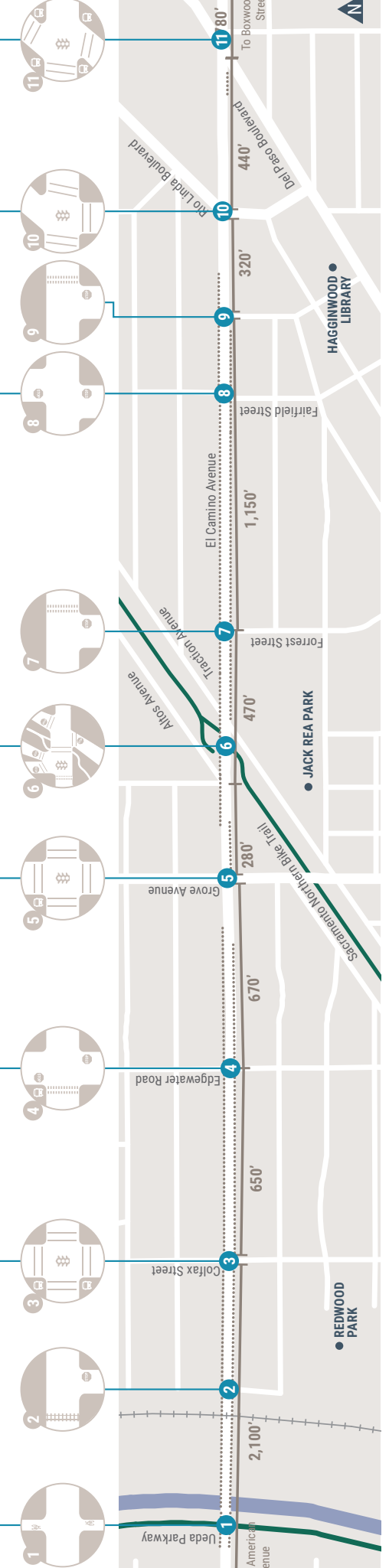

LET'S MOVE!

BUILDING COMMUNITY THROUGH MOVEMENT

City of
SACRAMENTO



**MCCLATCHY
PARK
3500 5TH AVE**

JOIN US

**LEARN ABOUT TRANSPORTATION PROJECTS IN YOUR NEIGHBORHOOD
& CELEBRATE MOVEMENT IN ALL FORMS**

Thursday

May 30

4:30–6:30pm

**ENJOY MUSIC, SNACKS, AND FAMILY-FRIENDLY ACTIVITIES
WHILE WE EXPLORE HOW TO IMPROVE OUR STREETS, MINDS, AND BODIES.**

MOVE!

**your mind and talk to us
about transportation projects
happening in your neighborhood:**

- Envision Broadway in Oak Park Complete Streets Plan
- Vision Zero Top Five Study (Broadway / Stockton corridor)
- Electric Vehicle Blueprint Project



MOVE!

**your body by
participating in:**

- Kids' obstacle course & games
- Group painting
- Guided tai chi
with *Classy Hippie Tea Company*
- Flow movement / yoga
with *Classy Hippie Tea Company*

Snacks & light refreshments to be provided by Oak Park Neighborhood Association

RSVP online at letsmovesac.eventbrite.com (RSVP's are requested, not required)

Let's talk street safety!

Florin Road & South Stockton Boulevard

Help the City identify transportation improvements for your neighborhood.

WEDS. JUNE 5

5:00 - 6:30 PM

**Luther Burbank High School
3500 Florin Road**

Join us to learn about and provide your input on proposed improvements to make it safer to walk, bike, and drive on Florin Road and South Stockton Boulevard. The improvements are a part of the City's Vision Zero Top Five Study.



RSVP online at
[visionzerosac1.eventbrite.com](https://www.eventbrite.com/visionzerosac1)
RSVPs are requested, but not required



City of
SACRAMENTO

Let's talk street safety!

El Camino Avenue & Marysville Boulevard

Learn about potential street improvements coming to your neighborhood!

THURS. JUNE 6

5:00 - 6:30 PM

**Greater Sacramento Urban League
3725 Marysville Boulevard**

Join us to learn about and provide your input on proposed improvements to make it safer to walk, bike, and drive on El Camino Avenue and Marysville Boulevard. The improvements are a part of the City's **Vision Zero Top Five Study**.

 **311** Español | 中文 | Tagalog | Tiếng Việt | Hmoob | Русский



RSVP online at

visionzerosac2.eventbrite.com

RSVPs are requested, but not required

Appendix B

Technical Calculations

El Camino Avenue

Vision Zero Top 5 Corridor Recommendations Results Summary – El Camino Avenue

Vision Zero Top 5 Corridor Recommendations Implemented

- Signal coordination
- Shortened cycle length at El Camino Avenue/Colfax Street and El Camino Avenue/Grove Avenue
- New traffic signals at El Camino Avenue/Edgewater Road, El Camino Avenue/Altos Avenue/Traction Avenue, and El Camino Avenue/Fairfield Street
- Option 1 project at El Camino Avenue/Altos Avenue/Traction Avenue: close south leg of Traction Avenue, north leg of Traction Avenue, south leg of Altos Avenue, and restrict access to/from Hawthorne Avenue to right-in/right-out. Square-up north leg of Altos Avenue and install traffic signal. (Option 2 results included on next page)
- Extended clearance time at El Camino Avenue/Rio Linda Boulevard
- Pedestrian scramble phase at El Camino Avenue/Del Paso Boulevard
- Road diet on Del Paso Boulevard (extension of Marysville Boulevard road diet)

Speed & Travel Time Results

Travel Times (min)	Dir	Existing Conditions		VZ Recommendations		% Change	
		AM Peak Hour	PM Peak Hour	AM Peak Hour	PM Peak Hour	AM Peak Hour	PM Peak Hour
El Camino Ave - Colfax St to Del Paso Blvd	EB	3.0	3.5	3.8	4.1	26%	14%
	WB	3.2	4.2	4.1	4.6	27%	22%
Speed (mph)	Dir	Existing Conditions		VZ Recommendations		% Change	
		AM Peak Hour	PM Peak Hour	AM Peak Hour	PM Peak Hour	AM Peak Hour	PM Peak Hour
El Camino Ave - Colfax St to Del Paso Blvd	EB	21	18	16	15	-27%	-17%
	WB	21	16	19	14	-10%	-13%

Delay & LOS Results

Intersection	Existing Conditions		PM Peak Hour	VZ Recommendations	
	Control ¹	AM Peak Hour		Control	AM Peak Hour
Colfax Street/El Camino Avenue	Signal	A / 4	A / 7	Signal	A / 5
Edgewater Road/El Camino Avenue	SSSC	Not Analyzed	Not Analyzed	Signal	A / 4
Grove Avenue/El Camino Avenue	Signal	C / 24	E / 57	Signal	D / 41
Hawthorne Avenue/El Camino Avenue	SSSC	A (E) / 7 (40)	D (F) / 28 (77)	SSSC	A (A) / 3 (6)
Altos Avenue/El Camino Avenue	SSSC	Not Analyzed	Not Analyzed	Signal	A / 7
Traction Avenue/El Camino Avenue	SSSC	A (A) / 1 (5)	A (A) / 2 (10)	SSSC	A (A) / 2 (6)
Forrest Street/El Camino Avenue	SSSC	Not Analyzed	Not Analyzed	Signal	A / 3
Fairfield Street/El Camino Avenue	SSSC	A (A) / 1 (4)	A (A) / 2 (10)	SSSC	A (A) / 2 (4)
Cantallier Street/El Camino Avenue	Signal	A / 7	B / 11	Signal	B / 12
Rio Linda Boulevard/El Camino Avenue	Signal	C / 26	D / 37	Signal	D / 45
Del Paso Boulevard/Beaumont Street/El Camino Avenue	Signal			Signal	E / 78

Vision Zero Top 5 Corridor Recommendations Results Summary – El Camino Avenue

Peak Hour Maximum Queue Results – El Camino Avenue/Del Paso Boulevard/Beaumont Street

Approach	Lane	Storage (ft)	Peak Hour Maximum Queue (ft)	
			AM Peak Hour	PM Peak Hour
NB	Through	1,350	125	425
	Through/Right	1,350	125	450
	Left	175	200	200
SB	Through	1,275	275	250
	Right	200	125	100
EB	Left	300	325	300
	Through	450	500	475
	Right	125	175	75
WB	Left	150	175	325
	Through/Right	575	325	950

Option 2 Results – El Camino Avenue/Altos Avenue/Traction Avenue

Intersection	Existing Conditions			VZ Recommendations – Option 2		
	Control ¹	AM Peak Hour	PM Peak Hour	Control	AM Peak Hour	PM Peak Hour
Hawthorne Avenue/El Camino Avenue	SSSC	A (E) / 7 (40)	D (F) / 28 (77)	SSSC	A (A) / 3 (6)	A / 10
Altos Avenue/El Camino Avenue	SSSC	<i>Not Analyzed</i>	<i>Not Analyzed</i>	Signal	B / 17	D / 38

Arterial Level of Service: EB El Camino Av

Cross Street	Node	Delay (s/veh)	Travel time (s)	Dist (mi)	Arterial Speed
Colfax St	12	3.2	26.4	0.2	27
Edgewater Rd	119	1.3	17.0	0.1	28
Grove Av	13	18.8	34.5	0.1	14
Altos Av	14	4.3	10.7	0.1	22
PED CROSSING	300	1.3	5.5	0.0	13
Traction Av	120	0.6	2.6	0.0	37
Forrest St	15	1.0	8.9	0.1	24
Fairfield St	121	1.3	20.1	0.2	29
Cantalier St	16	0.8	7.7	0.1	28
Rio Linda Bl	17	4.1	12.6	0.1	20
	117	3.8	11.8	0.1	20
Del Paso Bl	18	21.1	24.5	0.0	7
Total		61.6	182.2	1.0	21

Arterial Level of Service: WB El Camino Av

Cross Street	Node	Delay (s/veh)	Travel time (s)	Dist (mi)	Arterial Speed
Del Paso Bl	18	22.4	51.6	0.3	22
	117	1.8	9.0	0.0	19
Rio Linda Bl	17	5.2	12.3	0.1	19
Cantalier St	16	1.4	10.7	0.1	24
Fairfield St	121	0.4	7.3	0.1	29
Forrest St	15	1.5	20.5	0.2	28
Traction Av	120	1.9	7.9	0.1	27
PED CROSSING	300	1.7	5.7	0.0	17
Altos Av	14	0.9	2.4	0.0	29
Grove Av	13	20.9	29.5	0.1	8
Edgewater Rd	119	2.2	18.4	0.1	27
Colfax St	12	3.5	18.9	0.1	25
Total		63.8	194.1	1.2	21

Arterial Level of Service: EB El Camino Av

Cross Street	Node	Delay (s/veh)	Travel time (s)	Dist (mi)	Arterial Speed
Colfax St	12	6.6	29.9	0.2	24
Edgewater Rd	119	2.1	17.6	0.1	27
Grove Av	13	35.9	50.5	0.1	10
Altos Av	14	6.8	13.2	0.1	18
PED CROSSING	300	2.1	6.4	0.0	11
Traction Av	120	0.3	2.0	0.0	49
Forrest St	15	1.0	8.8	0.1	24
Fairfield St	121	1.6	20.8	0.2	28
Cantalier St	16	0.9	7.8	0.1	27
Rio Linda Blvd	17	6.8	15.3	0.1	16
	117	6.3	14.4	0.1	16
Del Paso Blvd	18	21.9	25.3	0.0	7
Total		92.2	211.9	1.0	18

Arterial Level of Service: WB El Camino Av

Cross Street	Node	Delay (s/veh)	Travel time (s)	Dist (mi)	Arterial Speed
Del Paso Blvd	18	44.4	73.5	0.3	16
	117	3.6	10.8	0.0	16
Rio Linda Blvd	17	8.6	15.6	0.1	15
Cantalier St	16	2.2	11.4	0.1	22
Fairfield St	121	0.8	7.6	0.1	28
Forrest St	15	7.0	23.3	0.2	25
Traction Av	120	11.9	16.9	0.1	12
PED CROSSING	300	8.3	11.9	0.0	8
Altos Av	14	2.5	3.6	0.0	20
Grove Av	13	30.6	37.8	0.1	6
Edgewater Rd	119	2.9	19.0	0.1	26
Colfax St	12	6.1	21.7	0.1	22
Total		128.9	253.3	1.2	16

Arterial Level of Service
 Vision Zero Top 5 Recommendations

AM Peak Hour
 Vision Zero - Top 5 Corridors

Arterial Level of Service: EB El Camino Av

Cross Street	Node	Delay (s/veh)	Travel time (s)	Dist (mi)	Arterial Speed
	154	5.0	14.6	0.1	20
Colfax St	12	4.4	18.5	0.1	23
Edgewater Rd	119	3.7	19.2	0.1	25
Grove Av	13	23.8	39.7	0.1	12
Hawthorne Av	156	3.1	10.6	0.1	21
Altos Av	14	2.2	5.1	0.0	17
Forrest St	15	1.3	11.2	0.1	27
Fairfield St	121	6.0	25.3	0.2	23
Cantalier St	16	1.7	8.6	0.1	25
Rio Linda Bl	17	9.3	17.7	0.1	14
Del Paso Bl	18	47.5	59.4	0.1	7
Total		108.0	229.8	1.0	16

Arterial Level of Service: WB El Camino Av

Cross Street	Node	Delay (s/veh)	Travel time (s)	Dist (mi)	Arterial Speed
Del Paso Bl	18	28.3	58.2	0.3	20
Rio Linda Bl	17	8.2	21.5	0.1	19
Cantalier St	16	2.1	11.2	0.1	22
Fairfield St	121	4.7	11.5	0.1	18
Forrest St	15	2.4	21.2	0.2	27
Altos Av	14	7.3	17.1	0.1	18
Hawthorne Av	156	3.6	6.5	0.0	13
Grove Av	13	32.8	40.0	0.1	6
Edgewater Rd	119	3.8	20.0	0.1	24
Colfax St	12	4.2	19.7	0.1	24
	154	5.4	19.7	0.1	22
Total		102.8	246.7	1.3	19

Arterial Level of Service
 Vision Zero Top 5 Recommendations

PM Peak Hour
 Vision Zero - Top 5 Corridors

Arterial Level of Service: EB El Camino Av

Cross Street	Node	Delay (s/veh)	Travel time (s)	Dist (mi)	Arterial Speed
	154	3.9	13.5	0.1	22
Colfax St	12	5.3	19.3	0.1	22
Edgewater Rd	119	3.6	19.2	0.1	25
Grove Av	13	22.2	37.5	0.1	13
Hawthorne Av	156	7.0	14.5	0.1	15
Altos Av	14	5.1	8.1	0.0	10
Forrest St	15	1.8	11.7	0.1	26
Fairfield St	121	11.2	30.3	0.2	19
Cantalier St	16	1.7	8.5	0.1	25
Rio Linda Blvd	17	8.8	17.3	0.1	15
Del Paso Blvd	18	50.9	62.7	0.1	7
Total		121.6	242.6	1.0	15

Arterial Level of Service: WB El Camino Av

Cross Street	Node	Delay (s/veh)	Travel time (s)	Dist (mi)	Arterial Speed
Del Paso Blvd	18	100.0	129.2	0.3	9
Rio Linda Blvd	17	5.4	19.1	0.1	21
Cantalier St	16	2.8	12.0	0.1	21
Fairfield St	121	5.3	11.9	0.1	18
Forrest St	15	4.3	23.7	0.2	24
Altos Av	14	16.1	25.9	0.1	12
Hawthorne Av	156	7.1	10.0	0.0	8
Grove Av	13	38.6	45.7	0.1	5
Edgewater Rd	119	5.6	22.0	0.1	22
Colfax St	12	3.5	19.0	0.1	25
	154	5.0	19.4	0.1	22
Total		193.8	338.1	1.3	14

SimTraffic Post-Processor
Average Results from 10 Runs
Volume and Delay by Movement

Vision Zero Top 5 Corridors - El Camino Av
Vision Zero Top 5 Recommendations
AM Peak Hour

Intersection 12 Colfax St/El Camino Av Signal

Direction	Movement	Demand Volume (vph)	Served Volume (vph)		Total Delay (sec/veh)		
			Average	Percent	Average	Std. Dev.	LOS
NB	Left Turn	21	21	102.3%	35.7	5.9	D
	Through	8	7	81.9%	30.0	22.6	C
	Right Turn	8	8	100.1%	7.1	5.9	A
	Subtotal	37	36	97.4%	29.1	6.6	C
SB	Left Turn	4	1	18.2%	3.4	7.1	A
	Through	11	12	112.5%	22.6	14.8	C
	Right Turn	16	17	106.9%	6.8	3.4	A
	Subtotal	31	30	97.5%	14.1	7.4	B
EB	Left Turn	17	17	100.6%	7.2	3.3	A
	Through	442	471	106.6%	4.3	1.1	A
	Right Turn	34	34	100.6%	2.1	1.1	A
	Subtotal	493	523	106.0%	4.3	1.1	A
WB	Left Turn	15	15	99.5%	9.0	5.3	A
	Through	413	397	96.1%	3.9	1.6	A
	Right Turn						
	Subtotal	428	412	96.2%	4.1	1.6	A
Total		989	1,001	101.2%	5.4	0.9	A

Intersection 13 Grove Av/El Camino Av Signal

Direction	Movement	Demand Volume (vph)	Served Volume (vph)		Total Delay (sec/veh)		
			Average	Percent	Average	Std. Dev.	LOS
NB	Left Turn	23	24	106.0%	72.9	4.8	E
	Through	110	121	110.2%	50.2	4.9	D
	Right Turn	39	37	96.1%	39.9	10.6	D
	Subtotal	172	183	106.4%	50.9	5.0	D
SB	Left Turn	104	112	107.8%	63.9	9.8	E
	Through	157	185	118.0%	52.9	11.5	D
	Right Turn	59	60	102.4%	38.9	15.4	D
	Subtotal	320	358	111.8%	54.1	9.8	D
EB	Left Turn	44	43	97.6%	90.2	12.1	F
	Through	375	378	100.8%	23.2	3.2	C
	Right Turn	28	26	92.3%	19.0	7.5	B
	Subtotal	447	447	99.9%	29.3	3.4	C
WB	Left Turn	46	52	113.2%	66.3	18.2	E
	Through	341	318	93.3%	35.5	6.9	D
	Right Turn	36	36	100.1%	32.9	7.4	C
	Subtotal	423	406	96.0%	39.1	7.4	D
Total		1,362	1,394	102.3%	41.4	4.6	D

SimTraffic Post-Processor
Average Results from 10 Runs
Volume and Delay by Movement

Vision Zero Top 5 Corridors - El Camino Av
Vision Zero Top 5 Recommendations
AM Peak Hour

Intersection 14 Altos Av-Traction Av/El Camino Av Signal

Direction	Movement	Demand Volume (vph)	Served Volume (vph)		Total Delay (sec/veh)		
			Average	Percent	Average	Std. Dev.	LOS
NB	Left Turn						
	Through						
	Right Turn						
	Subtotal						
SB	Left Turn	13	8	61.6%	27.0	20.1	C
	Through						
	Right Turn	22	28	127.4%	12.3	7.8	B
	Subtotal	35	36	103.0%	15.0	6.8	B
EB	Left Turn	24	20	84.9%	8.2	5.9	A
	Through	494	497	100.6%	4.8	2.7	A
	Right Turn						
	Subtotal	518	517	99.9%	5.0	2.9	A
WB	Left Turn						
	Through	408	388	95.2%	9.5	5.8	A
	Right Turn	12	12	97.1%	7.7	12.7	A
	Subtotal	420	400	95.2%	9.5	6.1	A
Total		973	953	98.0%	7.3	3.5	A

Intersection 15 Forrest St/El Camino Av Side-street Stop

Direction	Movement	Demand Volume (vph)	Served Volume (vph)		Total Delay (sec/veh)		
			Average	Percent	Average	Std. Dev.	LOS
NB	Left Turn	2	0	18.2%	1.2	3.8	A
	Through						
	Right Turn	12	9	78.9%	4.3	2.2	A
	Subtotal	14	10	70.2%	4.5	2.2	A
SB	Left Turn						
	Through						
	Right Turn						
	Subtotal						
EB	Left Turn						
	Through	496	499	100.5%	1.3	0.2	A
	Right Turn	11	9	86.0%	0.7	0.6	A
	Subtotal	507	508	100.2%	1.3	0.2	A
WB	Left Turn	9	7	76.8%	5.5	3.5	A
	Through	418	406	97.2%	2.2	0.9	A
	Right Turn						
	Subtotal	427	413	96.8%	2.3	0.9	A
Total		948	931	98.2%	1.8	0.5	A

SimTraffic Post-Processor
Average Results from 10 Runs
Volume and Delay by Movement

Vision Zero Top 5 Corridors - El Camino Av
Vision Zero Top 5 Recommendations
AM Peak Hour

Intersection 16 **Cantalier St/El Camino Av** **Side-street Stop**

Direction	Movement	Demand Volume (vph)	Served Volume (vph)		Total Delay (sec/veh)		
			Average	Percent	Average	Std. Dev.	LOS
NB	Left Turn	1	1	109.2%	3.9	7.6	A
	Through						
	Right Turn	5	4	80.1%	4.6	5.8	A
	Subtotal	6	5	84.9%	6.6	5.8	A
SB	Left Turn						
	Through						
	Right Turn						
	Subtotal						
EB	Left Turn						
	Through	484	488	100.8%	1.6	0.4	A
	Right Turn	8	10	122.9%	1.5	1.4	A
	Subtotal	492	498	101.1%	1.6	0.5	A
WB	Left Turn	4	1	36.4%	4.0	6.4	A
	Through	409	399	97.5%	1.9	0.5	A
	Right Turn						
	Subtotal	413	400	96.9%	2.0	0.5	A
Total		911	903	99.1%	1.8	0.4	A

Intersection 17 **Rio Linda Bl/El Camino Av** **Signal**

Direction	Movement	Demand Volume (vph)	Served Volume (vph)		Total Delay (sec/veh)		
			Average	Percent	Average	Std. Dev.	LOS
NB	Left Turn	4	1	36.4%	12.2	20.1	B
	Through	14	15	106.6%	22.3	6.0	C
	Right Turn	1	1	109.2%	3.4	7.0	A
	Subtotal	19	17	92.0%	22.3	4.7	C
SB	Left Turn	36	36	100.1%	27.1	6.9	C
	Through	58	56	97.3%	29.7	4.5	C
	Right Turn	56	49	87.1%	16.7	4.2	B
	Subtotal	150	141	94.2%	24.8	4.9	C
EB	Left Turn	26	29	113.4%	15.7	7.1	B
	Through	460	471	102.5%	10.3	6.0	B
	Right Turn	3	4	121.3%	3.5	2.8	A
	Subtotal	489	505	103.2%	10.5	5.8	B
WB	Left Turn	3	3	84.9%	4.3	6.8	A
	Through	353	349	98.8%	7.2	2.3	A
	Right Turn	14	14	98.8%	3.5	1.7	A
	Subtotal	370	365	98.7%	7.0	2.3	A
Total		1,028	1,028	100.0%	11.5	3.7	B

SimTraffic Post-Processor
Average Results from 10 Runs
Volume and Delay by Movement

Vision Zero Top 5 Corridors - El Camino Av
Vision Zero Top 5 Recommendations
AM Peak Hour

Intersection 156 Hawthorne Av/El Camino Av Side-street Stop

Direction	Movement	Demand Volume (vph)	Served Volume (vph)		Total Delay (sec/veh)		
			Average	Percent	Average	Std. Dev.	LOS
NB	Left Turn						
	Through						
	Right Turn						
	Subtotal						
SB	Left Turn						
	Through						
	Right Turn	8	8	100.1%	5.7	6.9	A
	Subtotal	8	8	100.1%	5.7	6.9	A
EB	Left Turn						
	Through	518	519	100.2%	2.6	1.3	A
	Right Turn						
	Subtotal	518	519	100.2%	2.6	1.3	A
WB	Left Turn						
	Through	415	401	96.6%	3.5	1.5	A
	Right Turn	15	16	104.3%	1.0	1.5	A
	Subtotal	430	416	96.8%	3.4	1.4	A
Total		956	943	98.7%	3.0	1.1	A

SimTraffic Post-Processor
Average Results from 10 Runs
Volume and Delay by Movement

Vision Zero Top 5 Corridors - El Camino Av
Vision Zero Top 5 Recommendations
AM Peak Hour

Intersection 16 **Cantalier St/El Camino Av** **Side-street Stop**

Direction	Movement	Demand Volume (vph)	Served Volume (vph)		Total Delay (sec/veh)		
			Average	Percent	Average	Std. Dev.	LOS
NB	Left Turn	1	1	109.2%	3.9	7.6	A
	Through						
	Right Turn	5	4	80.1%	4.6	5.8	A
	Subtotal	6	5	84.9%	6.6	5.8	A
SB	Left Turn						
	Through						
	Right Turn						
	Subtotal						
EB	Left Turn						
	Through	484	488	100.8%	1.6	0.4	A
	Right Turn	8	10	122.9%	1.5	1.4	A
	Subtotal	492	498	101.1%	1.6	0.5	A
WB	Left Turn	4	1	36.4%	4.0	6.4	A
	Through	409	399	97.5%	1.9	0.5	A
	Right Turn						
	Subtotal	413	400	96.9%	2.0	0.5	A
Total		911	903	99.1%	1.8	0.4	A

Intersection 17 **Rio Linda Bl/El Camino Av** **Signal**

Direction	Movement	Demand Volume (vph)	Served Volume (vph)		Total Delay (sec/veh)		
			Average	Percent	Average	Std. Dev.	LOS
NB	Left Turn	4	1	36.4%	12.2	20.1	B
	Through	14	15	106.6%	22.3	6.0	C
	Right Turn	1	1	109.2%	3.4	7.0	A
	Subtotal	19	17	92.0%	22.3	4.7	C
SB	Left Turn	36	36	100.1%	27.1	6.9	C
	Through	58	56	97.3%	29.7	4.5	C
	Right Turn	56	49	87.1%	16.7	4.2	B
	Subtotal	150	141	94.2%	24.8	4.9	C
EB	Left Turn	26	29	113.4%	15.7	7.1	B
	Through	460	471	102.5%	10.3	6.0	B
	Right Turn	3	4	121.3%	3.5	2.8	A
	Subtotal	489	505	103.2%	10.5	5.8	B
WB	Left Turn	3	3	84.9%	4.3	6.8	A
	Through	353	349	98.8%	7.2	2.3	A
	Right Turn	14	14	98.8%	3.5	1.7	A
	Subtotal	370	365	98.7%	7.0	2.3	A
Total		1,028	1,028	100.0%	11.5	3.7	B

SimTraffic Post-Processor
Average Results from 10 Runs
Volume and Delay by Movement

Vision Zero Top 5 Corridors - El Camino Av
Vision Zero Top 5 Recommendations
AM Peak Hour

Intersection 156 Hawthorne Av/El Camino Av Side-street Stop

Direction	Movement	Demand Volume (vph)	Served Volume (vph)		Total Delay (sec/veh)		
			Average	Percent	Average	Std. Dev.	LOS
NB	Left Turn						
	Through						
	Right Turn						
	Subtotal						
SB	Left Turn						
	Through						
	Right Turn	8	8	100.1%	5.7	6.9	A
	Subtotal	8	8	100.1%	5.7	6.9	A
EB	Left Turn						
	Through	518	519	100.2%	2.6	1.3	A
	Right Turn						
	Subtotal	518	519	100.2%	2.6	1.3	A
WB	Left Turn						
	Through	415	401	96.6%	3.5	1.5	A
	Right Turn	15	16	104.3%	1.0	1.5	A
	Subtotal	430	416	96.8%	3.4	1.4	A
Total		956	943	98.7%	3.0	1.1	A

SimTraffic Post-Processor
Average Results from 10 Runs
Volume and Delay by Movement

Vision Zero Top 5 Corridors - El Camino Av
Vision Zero Top 5 Recommendations
PM Peak Hour

Intersection 12 Colfax St/El Camino Av Signal

Direction	Movement	Demand Volume (vph)	Served Volume (vph)		Total Delay (sec/veh)		LOS
			Average	Percent	Average	Std. Dev.	
NB	Left Turn	43	44	102.0%	34.8	9.0	C
	Through	15	12	77.6%	23.1	15.3	C
	Right Turn	23	22	96.2%	13.1	7.5	B
	Subtotal	81	78	95.8%	27.7	5.6	C
SB	Left Turn	2	2	97.0%	13.0	23.3	B
	Through	7	7	94.2%	38.0	20.5	D
	Right Turn	25	29	116.4%	7.0	2.1	A
	Subtotal	34	38	110.7%	13.6	4.6	B
EB	Left Turn	38	38	101.1%	8.4	4.7	A
	Through	585	577	98.6%	5.1	2.1	A
	Right Turn	26	28	107.4%	3.2	2.4	A
	Subtotal	649	643	99.1%	5.2	2.2	A
WB	Left Turn	12	10	80.8%	13.3	11.3	B
	Through	596	492	82.6%	3.5	0.8	A
	Right Turn	4	3	77.6%	2.1	3.8	A
	Subtotal	612	505	82.5%	3.6	0.7	A
Total		1,376	1,264	91.8%	6.2	1.2	A

Intersection 13 Grove Av/El Camino Av Signal

Direction	Movement	Demand Volume (vph)	Served Volume (vph)		Total Delay (sec/veh)		LOS
			Average	Percent	Average	Std. Dev.	
NB	Left Turn	54	57	105.6%	47.7	15.8	D
	Through	278	284	102.3%	39.2	12.7	D
	Right Turn	67	61	90.3%	31.9	12.5	C
	Subtotal	399	402	100.7%	39.4	12.7	D
SB	Left Turn	93	94	100.5%	43.7	12.1	D
	Through	140	139	99.5%	28.7	4.7	C
	Right Turn	65	63	97.3%	19.4	6.0	B
	Subtotal	298	296	99.3%	31.6	4.1	C
EB	Left Turn	62	56	90.7%	56.4	7.1	E
	Through	500	491	98.2%	20.9	6.1	C
	Right Turn	30	31	102.2%	18.7	10.0	B
	Subtotal	592	578	97.7%	24.2	5.6	C
WB	Left Turn	47	41	86.7%	66.0	14.0	E
	Through	495	409	82.6%	43.7	9.6	D
	Right Turn	47	45	96.6%	39.3	12.1	D
	Subtotal	589	495	84.1%	45.0	10.0	D
Total		1,878	1,771	94.3%	35.0	5.0	C

SimTraffic Post-Processor
Average Results from 10 Runs
Volume and Delay by Movement

Vision Zero Top 5 Corridors - El Camino Av
Vision Zero Top 5 Recommendations
PM Peak Hour

Intersection 14 Altos Av-Traction Av/El Camino Av Signal

Direction	Movement	Demand Volume (vph)	Served Volume (vph)		Total Delay (sec/veh)		
			Average	Percent	Average	Std. Dev.	LOS
NB	Left Turn						
	Through						
	Right Turn						
	Subtotal						
SB	Left Turn	7	7	94.2%	33.2	28.4	C
	Through						
	Right Turn	17	15	86.7%	17.7	20.9	B
	Subtotal	24	21	88.9%	27.9	22.1	C
EB	Left Turn	45	44	98.3%	17.3	5.7	B
	Through	615	603	98.0%	10.6	3.6	B
	Right Turn						
	Subtotal	660	647	98.0%	11.1	3.6	B
WB	Left Turn						
	Through	602	552	91.7%	18.9	18.1	B
	Right Turn	9	10	112.1%	16.4	15.5	B
	Subtotal	611	562	92.0%	18.8	18.1	B
Total		1,295	1,230	95.0%	15.2	9.4	B

Intersection 15 Forrest St/El Camino Av Side-street Stop

Direction	Movement	Demand Volume (vph)	Served Volume (vph)		Total Delay (sec/veh)		
			Average	Percent	Average	Std. Dev.	LOS
NB	Left Turn	6	4	64.7%	18.2	24.6	C
	Through						
	Right Turn	17	20	116.4%	5.9	3.0	A
	Subtotal	23	24	102.9%	8.6	7.2	A
SB	Left Turn						
	Through						
	Right Turn						
	Subtotal						
EB	Left Turn						
	Through	604	593	98.2%	1.7	0.4	A
	Right Turn	18	16	88.4%	1.4	0.9	A
	Subtotal	622	609	97.9%	1.7	0.4	A
WB	Left Turn	11	10	88.2%	8.8	9.5	A
	Through	605	581	96.0%	4.0	4.0	A
	Right Turn						
	Subtotal	616	591	95.9%	4.1	4.1	A
Total		1,261	1,223	97.0%	3.1	2.2	A

SimTraffic Post-Processor
Average Results from 10 Runs
Volume and Delay by Movement

Vision Zero Top 5 Corridors - El Camino Av
Vision Zero Top 5 Recommendations
PM Peak Hour

Intersection 16 Cantalier St/El Camino Av Side-street Stop

Direction	Movement	Demand Volume (vph)	Served Volume (vph)		Total Delay (sec/veh)		
			Average	Percent	Average	Std. Dev.	LOS
NB	Left Turn	9	10	112.1%	22.5	18.4	C
	Through						
	Right Turn	22	26	118.2%	7.4	2.8	A
	Subtotal	31	36	116.4%	12.4	5.3	B
SB	Left Turn						
	Through						
	Right Turn						
	Subtotal						
EB	Left Turn						
	Through	622	596	95.8%	1.7	0.5	A
	Right Turn	2	2	116.4%	0.6	0.8	A
	Subtotal	624	598	95.9%	1.6	0.5	A
WB	Left Turn	8	6	77.6%	4.6	4.8	A
	Through	610	566	92.8%	2.9	0.8	A
	Right Turn						
	Subtotal	618	572	92.6%	2.9	0.8	A
Total		1,273	1,207	94.8%	2.6	0.5	A

Intersection 17 Rio Linda Bl/El Camino Av Signal

Direction	Movement	Demand Volume (vph)	Served Volume (vph)		Total Delay (sec/veh)		
			Average	Percent	Average	Std. Dev.	LOS
NB	Left Turn	10	9	89.2%	31.8	20.6	C
	Through	54	53	98.4%	29.7	6.8	C
	Right Turn	4	5	135.8%	9.0	10.9	A
	Subtotal	68	68	99.3%	28.7	7.3	C
SB	Left Turn	21	21	97.9%	36.2	13.9	D
	Through	61	62	101.8%	33.9	6.5	C
	Right Turn	44	43	97.0%	22.0	6.5	C
	Subtotal	126	125	99.5%	29.7	4.8	C
EB	Left Turn	65	62	94.9%	21.5	6.7	C
	Through	571	544	95.3%	10.6	2.3	B
	Right Turn	8	7	82.5%	7.6	8.5	A
	Subtotal	644	613	95.1%	11.8	2.3	B
WB	Left Turn	11	9	84.7%	16.6	8.7	B
	Through	564	503	89.2%	6.9	1.7	A
	Right Turn	12	10	84.1%	4.6	4.1	A
	Subtotal	587	523	89.0%	7.1	1.7	A
Total		1,425	1,328	93.2%	12.4	0.8	B

SimTraffic Post-Processor
Average Results from 10 Runs
Volume and Delay by Movement

Vision Zero Top 5 Corridors - El Camino Av
Vision Zero Top 5 Recommendations
PM Peak Hour

Intersection 18

Del Paso Bl/El Camino Av

Signal

Direction	Movement	Demand Volume (vph)	Served Volume (vph)		Total Delay (sec/veh)		
			Average	Percent	Average	Std. Dev.	LOS
NB	Left Turn						
	Through	383	350	91.4%	121.5	31.5	F
	Right Turn	82	78	95.1%	120.7	33.4	F
	Subtotal	465	428	92.0%	121.5	31.4	F
SB	Left Turn	116	112	96.7%	82.7	26.5	F
	Through	170	176	103.6%	47.2	4.8	D
	Right Turn	64	76	118.8%	43.0	6.5	D
	Subtotal	350	364	104.1%	57.3	8.4	E
EB	Left Turn	99	112	113.3%	72.5	10.3	E
	Through	473	378	79.9%	50.8	8.4	D
	Right Turn	24	21	85.7%	27.6	11.8	C
	Subtotal	596	511	85.7%	54.7	7.9	D
WB	Left Turn	84	73	86.4%	103.7	36.5	F
	Through	523	424	81.2%	91.7	29.8	F
	Right Turn	85	89	104.5%	3.0	0.4	A
	Subtotal	692	586	84.7%	79.8	26.0	E
Total		2,103	1,889	89.8%	78.1	6.0	E

SimTraffic Post-Processor
Average Results from 10 Runs
Volume and Delay by Movement

Vision Zero Top 5 Corridors - El Camino Av
Vision Zero Top 5 Recommendations
PM Peak Hour

Intersection 119 Edgewater Rd/El Camino Av Signal

Direction	Movement	Demand Volume (vph)	Served Volume (vph)		Total Delay (sec/veh)		LOS
			Average	Percent	Average	Std. Dev.	
NB	Left Turn	3	0	12.9%	0.3	0.9	A
	Through	1	1	77.6%	8.5	18.1	A
	Right Turn	7	6	88.7%	6.2	5.3	A
	Subtotal	11	7	67.0%	9.2	9.2	A
SB	Left Turn	5	5	93.1%	32.7	21.9	C
	Through	1	0	38.8%	5.0	15.9	A
	Right Turn	11	13	119.9%	8.8	6.4	A
	Subtotal	17	18	107.3%	15.6	10.8	B
EB	Left Turn	24	29	121.3%	8.0	2.9	A
	Through	580	572	98.7%	3.7	1.8	A
	Right Turn	6	5	77.6%	0.6	0.9	A
	Subtotal	610	606	99.4%	3.8	1.8	A
WB	Left Turn	2	1	58.2%	2.8	5.8	A
	Through	598	512	85.6%	4.9	1.4	A
	Right Turn	14	16	113.6%	4.0	2.8	A
	Subtotal	614	529	86.2%	4.9	1.3	A
Total		1,252	1,161	92.7%	4.6	1.5	A

Intersection 121 Fairfield St/El Camino Av Signal

Direction	Movement	Demand Volume (vph)	Served Volume (vph)		Total Delay (sec/veh)		LOS
			Average	Percent	Average	Std. Dev.	
NB	Left Turn	15	12	82.8%	42.6	9.9	D
	Through	9	8	90.5%	41.6	19.3	D
	Right Turn	62	59	95.1%	10.7	3.7	B
	Subtotal	86	80	92.5%	17.7	3.9	B
SB	Left Turn	4	3	77.6%	19.2	26.8	B
	Through	3	3	116.4%	15.0	19.9	B
	Right Turn	35	30	85.4%	8.6	2.4	A
	Subtotal	42	36	86.8%	11.2	5.2	B
EB	Left Turn	43	48	111.0%	18.5	9.5	B
	Through	558	543	97.3%	12.4	5.5	B
	Right Turn	20	23	114.5%	8.3	7.7	A
	Subtotal	621	614	98.8%	12.8	5.8	B
WB	Left Turn	7	6	83.1%	8.0	12.2	A
	Through	566	537	94.9%	5.5	1.0	A
	Right Turn	45	50	111.2%	4.4	2.3	A
	Subtotal	618	593	95.9%	5.4	1.1	A
Total		1,367	1,323	96.8%	9.7	2.9	A

SimTraffic Post-Processor
Average Results from 10 Runs
Volume and Delay by Movement

Vision Zero Top 5 Corridors - El Camino Av
Vision Zero Top 5 Recommendations
PM Peak Hour

Intersection 156

Hawthorne Av/El Camino Av

Side-street Stop

Direction	Movement	Demand Volume (vph)	Served Volume (vph)		Total Delay (sec/veh)		
			Average	Percent	Average	Std. Dev.	LOS
NB	Left Turn						
	Through						
	Right Turn						
	Subtotal						
SB	Left Turn						
	Through						
	Right Turn	5	4	85.4%	31.2	43.2	D
	Subtotal	5	4	85.4%	31.2	43.2	D
EB	Left Turn						
	Through	660	647	98.0%	5.7	2.4	A
	Right Turn						
	Subtotal	660	647	98.0%	5.7	2.4	A
WB	Left Turn						
	Through	584	525	90.0%	6.5	3.3	A
	Right Turn	35	32	90.9%	3.7	2.7	A
	Subtotal	619	557	90.0%	6.3	3.1	A
Total		1,284	1,208	94.1%	6.2	2.1	A

Queuing and Blocking Report
 Vision Zero Top 5 Recommendations

AM Peak Hour
 Vision Zero - Top 5 Corridors

Intersection: 18: Del Paso Bl & Beaumont St & El Camino Av

Movement	EB	EB	EB	WB	WB	NB	NB	SB	SB	SB
Directions Served	L	TR	>	<L	T	T	TR>	<L	T	R
Maximum Queue (ft)	302	480	14	158	310	119	125	190	272	120
Average Queue (ft)	77	346	2	87	191	61	61	93	157	29
95th Queue (ft)	258	530	30	170	347	113	128	192	278	110
Link Distance (ft)		444			1582	1234	1234		325	
Upstream Blk Time (%)		9							0	
Queuing Penalty (veh)		47							2	
Storage Bay Dist (ft)	300		120	130				170		200
Storage Blk Time (%)		43		3	19			2	9	
Queuing Penalty (veh)		27		10	18			5	16	

Queuing and Blocking Report
 Vision Zero Top 5 Recommendations

PM Peak Hour
 Vision Zero - Top 5 Corridors

Intersection: 18: Del Paso Blvd & Beaumont St & El Camino Av

Movement	EB	EB	EB	WB	WB	WB	NB	NB	SB	SB	SB
Directions Served	L	TR	>	<L	T	R	T	TR>	<L	T	R
Maximum Queue (ft)	293	461	66	311	931	103	409	439	192	242	92
Average Queue (ft)	138	334	13	132	653	39	303	314	127	126	35
95th Queue (ft)	309	501	82	342	1112	364	472	500	245	247	107
Link Distance (ft)		444			1581	1581	1234	1234		325	
Upstream Blk Time (%)		6								1	
Queuing Penalty (veh)		36								2	
Storage Bay Dist (ft)	300		120	300					250		200
Storage Blk Time (%)		47			51				2	2	0
Queuing Penalty (veh)		55			44				6	4	0

SimTraffic Post-Processor
Average Results from 10 Runs
Volume and Delay by Movement

Vision Zero Top 5 Corridors - El Camino Av
Vision Zero Top 5 Recommendations - Option 2
AM Peak Hour

Intersection 14 Altos Av-Traction Av/El Camino Av Signal

Direction	Movement	Demand Volume (vph)	Served Volume (vph)		Total Delay (sec/veh)		
			Average	Percent	Average	Std. Dev.	LOS
NB	Left Turn	3	3	97.1%	42.8	44.7	D
	Through						
	Right Turn	22	17	77.8%	8.8	3.7	A
	Subtotal	25	20	80.1%	20.6	19.3	C
SB	Left Turn	13	9	72.8%	54.7	29.6	D
	Through						
	Right Turn	22	25	115.8%	12.2	7.2	B
	Subtotal	35	35	99.8%	25.8	14.5	C
EB	Left Turn	24	23	94.0%	23.1	12.2	C
	Through	472	457	96.9%	13.8	4.8	B
	Right Turn	9	8	89.0%	9.5	7.1	A
	Subtotal	505	488	96.6%	14.2	5.1	B
WB	Left Turn	27	23	83.6%	25.5	11.9	C
	Through	381	383	100.6%	19.9	8.8	B
	Right Turn	12	12	103.1%	10.8	12.5	B
	Subtotal	420	418	99.6%	20.0	8.9	B
Total		985	961	97.6%	17.3	6.1	B

SimTraffic Post-Processor
Average Results from 10 Runs
Volume and Delay by Movement

Vision Zero Top 5 Corridors - El Camino Av
Vision Zero Top 5 Recommendations - Option 2
PM Peak Hour

Intersection 14 Altos Av-Traction Av/El Camino Av Signal

Direction	Movement	Demand Volume (vph)	Served Volume (vph)		Total Delay (sec/veh)		
			Average	Percent	Average	Std. Dev.	LOS
NB	Left Turn	2	2	116.4%	59.1	70.4	E
	Through						
	Right Turn	32	37	115.2%	10.0	3.4	A
	Subtotal	34	39	115.3%	18.0	11.9	B
SB	Left Turn	7	5	72.1%	52.1	54.1	D
	Through						
	Right Turn	17	17	100.4%	16.4	15.6	B
	Subtotal	24	22	92.2%	29.8	26.2	C
EB	Left Turn	45	43	96.6%	37.7	14.7	D
	Through	583	560	96.0%	29.4	5.7	C
	Right Turn	8	10	131.0%	25.8	5.9	C
	Subtotal	636	614	96.5%	30.1	6.0	C
WB	Left Turn	26	22	83.6%	51.3	26.4	D
	Through	576	513	89.1%	48.3	21.8	D
	Right Turn	9	11	125.0%	39.8	30.9	D
	Subtotal	611	546	89.3%	48.5	21.9	D
Total		1,305	1,221	93.6%	38.0	10.7	D



Major Street El Camino Av
 Minor Street Altos Av/Hawthorne Rd

Project Vision Zero Top 5 Corridors
 Scenario El Camino Av - VZ Recommendation
 Peak Hour AM

Turn Movement Volumes

	SE	SB	EB	WB
Left	5	13	26	0
Through	0	22	476	372
Right	8	3	0	18
Total	13	38	502	390

Major Street Direction

	North/South
x	East/West

Intersection Geometry

Number of Approach Lanes for Minor Street	1
Total Approaches	4

Worst Case Delay for Minor Street

Stopped Delay (seconds per vehicle)	22
Approach with Worst Case Delay	SB
Total Vehicles on Approach	38

Warrant 3A, Peak Hour			
	Peak Hour Delay on Minor Approach (vehicle-hours)	Peak Hour Volume on Minor Approach (vph)	Peak Hour Entering Volume Serviced (vph)
Camino Av - VZ Recommendation	0.2	38	943
Limiting Value	4	100	800
Condition Satisfied?	Not Met	Not Met	Met
Warrant Met	<u>NO</u>		



Major Street **El Camino Av**
 Minor Street **Altos Av/Hawthorne Rd**

Project **Vision Zero Top 5 Corridors**
 Scenario **El Camino Av - VZ Recommendation**
 Peak Hour **AM**

Turn Movement Volumes

	SE	SB	EB	WB
Left	5	13	26	0
Through	0	22	476	372
Right	8	3	0	18
Total	13	38	502	390

Major Street Direction

North/South
x East/West

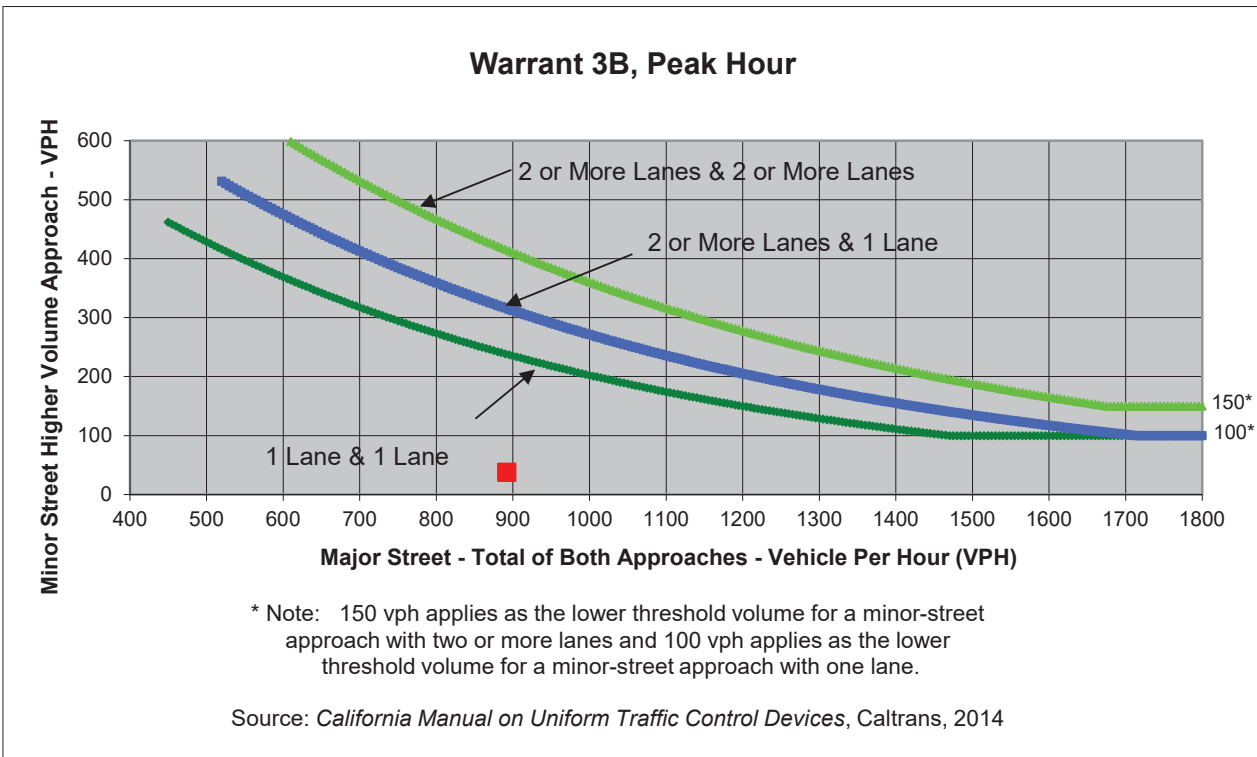

	Major Street	Minor Street	Warrant Met
	El Camino Av	Altos Av/Hawthorne Rd	
Number of Approach Lanes	1	1	<u>NO</u>
Traffic Volume (VPH) *	892	38	

* Note: Traffic Volume for Major Street is Total Volume of Both Approches.
 Traffic Volume for Minor Street is the Volume of High Volume Approach.



Major Street El Camino Av
 Minor Street Altos Av/Hawthorne Rd

Project Vision Zero Top 5 Corridors
 Scenario El Camino Av - VZ Recommendation
 Peak Hour PM

Turn Movement Volumes

	SE	SB	EB	WB
Left	8	7	52	0
Through	0	19	584	541
Right	5	1	0	46
Total	13	27	636	587

Major Street Direction

	North/South
x	East/West

Intersection Geometry

Number of Approach Lanes for Minor Street	1
Total Approaches	4

Worst Case Delay for Minor Street

Stopped Delay (seconds per vehicle)	77.1
Approach with Worst Case Delay	SB
Total Vehicles on Approach	27

Warrant 3A, Peak Hour			
	Peak Hour Delay on Minor Approach (vehicle-hours)	Peak Hour Volume on Minor Approach (vph)	Peak Hour Entering Volume Serviced (vph)
Camino Av - VZ Recommendation	0.6	27	1,263
Limiting Value	4	100	800
Condition Satisfied?	Not Met	Not Met	Met
Warrant Met	<u>NO</u>		



Major Street **El Camino Av**
 Minor Street **Altos Av/Hawthorne Rd**

Project **Vision Zero Top 5 Corridors**
 Scenario **El Camino Av - VZ Recommendation**
 Peak Hour **PM**

Turn Movement Volumes

	SE	SB	EB	WB
Left	8	7	52	0
Through	0	19	584	541
Right	5	1	0	46
Total	13	27	636	587

Major Street Direction

North/South
x East/West

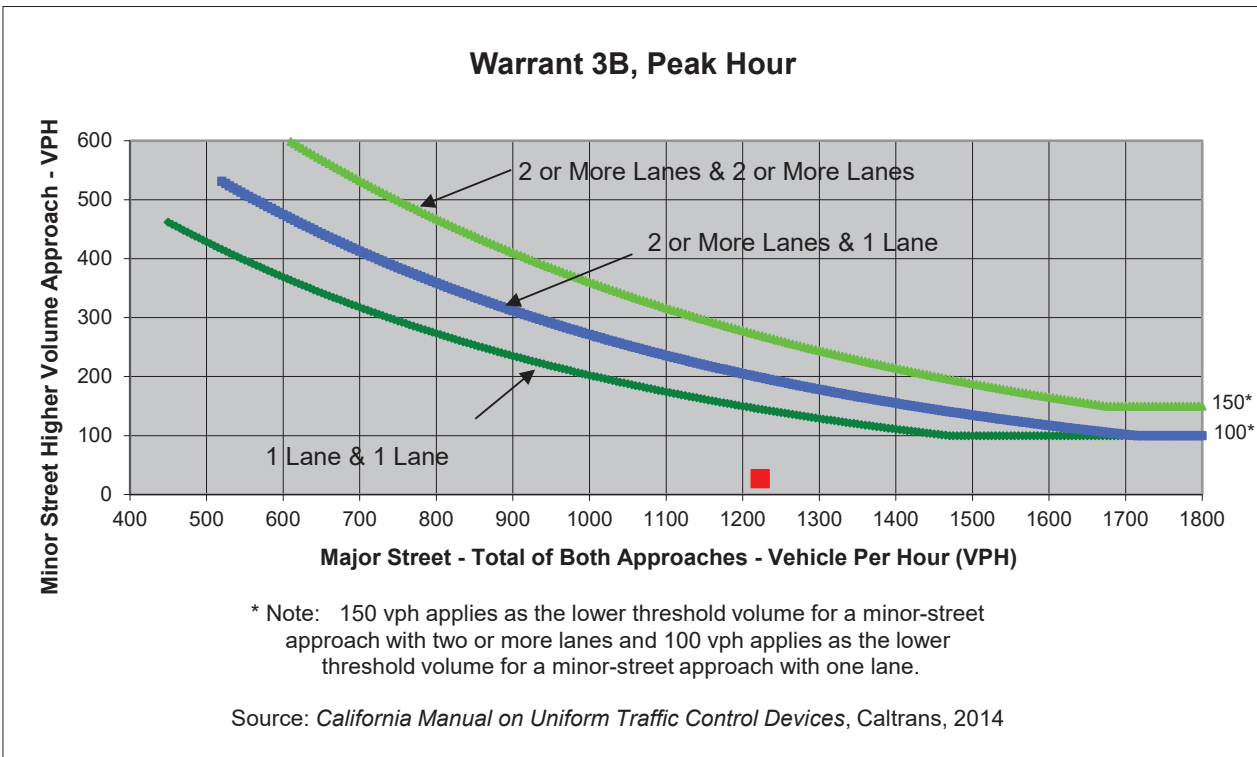

	Major Street	Minor Street	Warrant Met
	El Camino Av	Altos Av/Hawthorne Rd	
Number of Approach Lanes	1	1	<u>NO</u>
Traffic Volume (VPH) *	1,223	27	

* Note: Traffic Volume for Major Street is Total Volume of Both Approches.
 Traffic Volume for Minor Street is the Volume of High Volume Approach.



Major Street El Camino Av
 Minor Street Edgewater Rd

Project Vision Zero Top 5 Corridors
 Scenario El Camino Av - VZ Recommendation
 Peak Hour PM

Turn Movement Volumes

	NB	SB	EB	WB
Left	3	5	24	2
Through	1	1	580	598
Right	7	11	6	14
Total	11	17	610	614

Major Street Direction

	North/South
x	East/West

Intersection Geometry

Number of Approach Lanes for Minor Street	1
Total Approaches	4

Worst Case Delay for Minor Street

Stopped Delay (seconds per vehicle)	19.9
Approach with Worst Case Delay	SB
Total Vehicles on Approach	17

Warrant 3A, Peak Hour			
	Peak Hour Delay on Minor Approach (vehicle-hours)	Peak Hour Volume on Minor Approach (vph)	Peak Hour Entering Volume Serviced (vph)
Camino Av - VZ Recommendation	0.1	17	1,252
Limiting Value	4	100	800
Condition Satisfied?	Not Met	Not Met	Met
Warrant Met	<u>NO</u>		



Major Street El Camino Av
 Minor Street Edgewater Rd

Project Vision Zero Top 5 Corridors
 Scenario El Camino Av - VZ Recommendation
 Peak Hour PM

Turn Movement Volumes

	NB	SB	EB	WB
Left	3	5	24	2
Through	1	1	580	598
Right	7	11	6	14
Total	11	17	610	614

Major Street Direction

	North/South
x	East/West

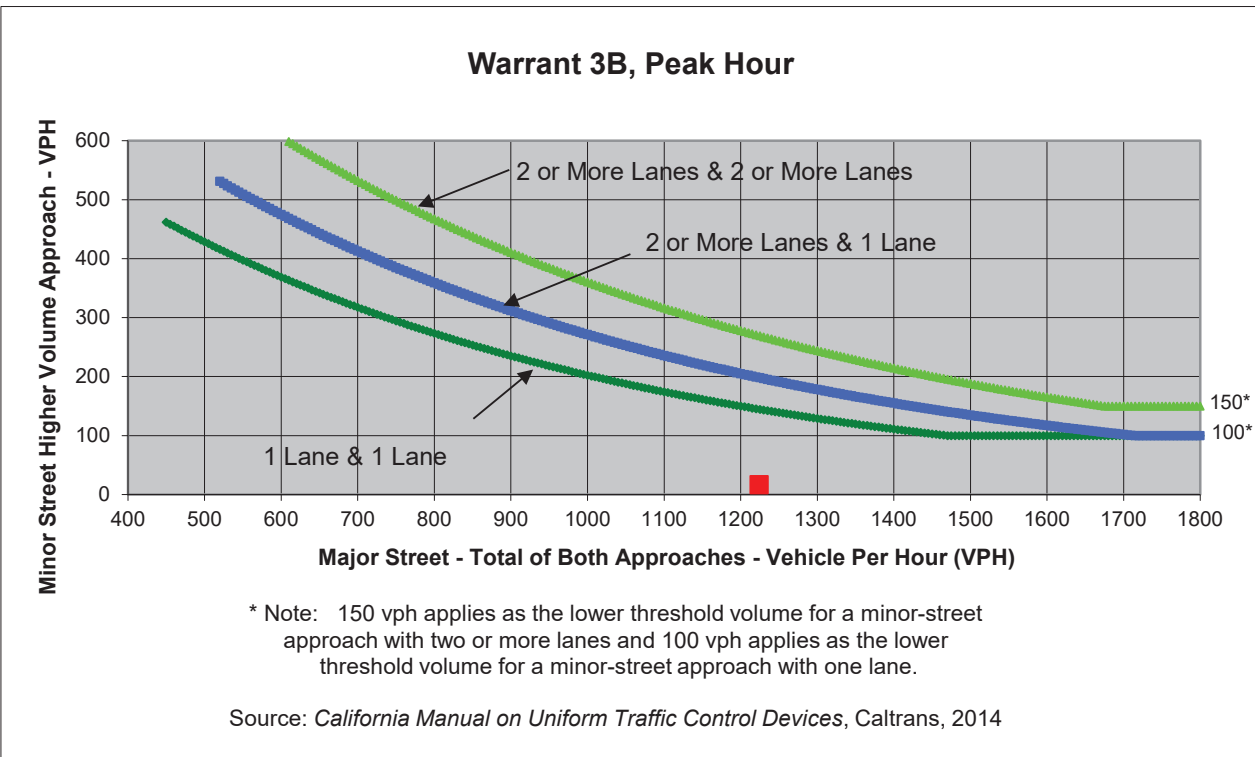

	Major Street	Minor Street	Warrant Met
	El Camino Av	Edgewater Rd	
Number of Approach Lanes	1	1	<u>NO</u>
Traffic Volume (VPH) *	1,224	17	

* Note: Traffic Volume for Major Street is Total Volume of Both Approches.
 Traffic Volume for Minor Street is the Volume of High Volume Approach.



Major Street El Camino Av
 Minor Street Edgewater Rd

Project Vision Zero Top 5 Corridors
 Scenario El Camino Av - VZ Recommendation
 Peak Hour AM

Turn Movement Volumes

	NB	SB	EB	WB
Left	1	3	19	11
Through	2	1	431	403
Right	13	24	4	9
Total	16	28	454	423

Major Street Direction

	North/South
x	East/West

Intersection Geometry

Number of Approach Lanes for Minor Street	1
Total Approaches	4

Worst Case Delay for Minor Street

Stopped Delay (seconds per vehicle)	13.4
Approach with Worst Case Delay	NB
Total Vehicles on Approach	16

Warrant 3A, Peak Hour			
	Peak Hour Delay on Minor Approach (vehicle-hours)	Peak Hour Volume on Minor Approach (vph)	Peak Hour Entering Volume Serviced (vph)
Camino Av - VZ Recommendation	0.1	28	921
Limiting Value	4	100	800
Condition Satisfied?	Not Met	Not Met	Met
Warrant Met	<u>NO</u>		



Major Street **El Camino Av**
 Minor Street **Edgewater Rd**

Project **Vision Zero Top 5 Corridors**
 Scenario **El Camino Av - VZ Recommendation**
 Peak Hour **AM**

Turn Movement Volumes

	NB	SB	EB	WB
Left	1	3	19	11
Through	2	1	431	403
Right	13	24	4	9
Total	16	28	454	423

Major Street Direction

North/South
x East/West

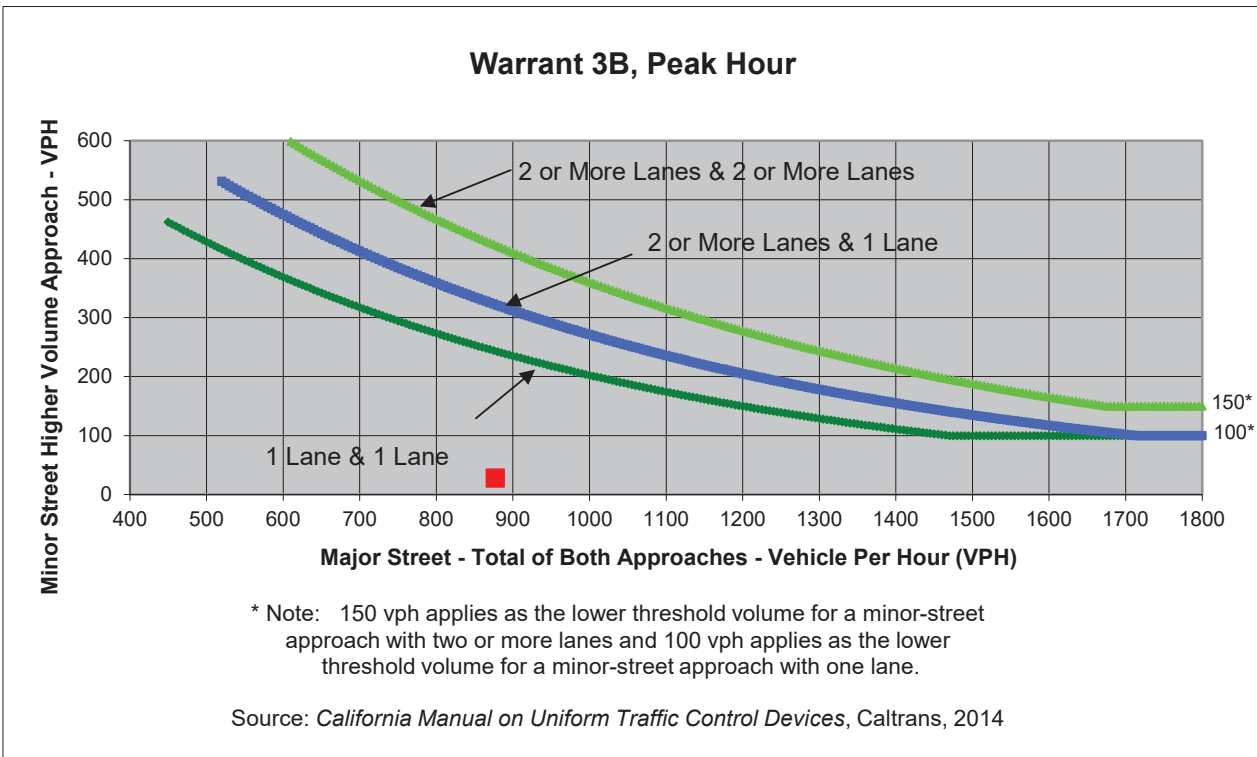

	Major Street	Minor Street	Warrant Met
	El Camino Av	Edgewater Rd	
Number of Approach Lanes	1	1	<u>NO</u>
Traffic Volume (VPH) *	877	28	

* Note: Traffic Volume for Major Street is Total Volume of Both Approches.
 Traffic Volume for Minor Street is the Volume of High Volume Approach.



Major Street El Camino Av
 Minor Street Fairfield Av

Project Vision Zero Top 5 Corridors
 Scenario El Camino Av - VZ Recommendation
 Peak Hour PM

Turn Movement Volumes

	NB	SB	EB	WB
Left	2	4	24	20
Through	10	6	566	567
Right	22	18	8	7
Total	34	28	598	594

Major Street Direction

	North/South
x	East/West

Intersection Geometry

Number of Approach Lanes for Minor Street	1
Total Approaches	4

Worst Case Delay for Minor Street

Stopped Delay (seconds per vehicle)	20.5
Approach with Worst Case Delay	SB
Total Vehicles on Approach	28

Warrant 3A, Peak Hour			
	Peak Hour Delay on Minor Approach (vehicle-hours)	Peak Hour Volume on Minor Approach (vph)	Peak Hour Entering Volume Serviced (vph)
Camino Av - VZ Recommendation	0.2	34	1,254
Limiting Value	4	100	800
Condition Satisfied?	Not Met	Not Met	Met
Warrant Met	<u>NO</u>		



Major Street **El Camino Av**
 Minor Street **Fairfield Av**

Project **Vision Zero Top 5 Corridors**
 Scenario **El Camino Av - VZ Recommendation**
 Peak Hour **PM**

Turn Movement Volumes

	NB	SB	EB	WB
Left	2	4	24	20
Through	10	6	566	567
Right	22	18	8	7
Total	34	28	598	594

Major Street Direction

North/South
x East/West

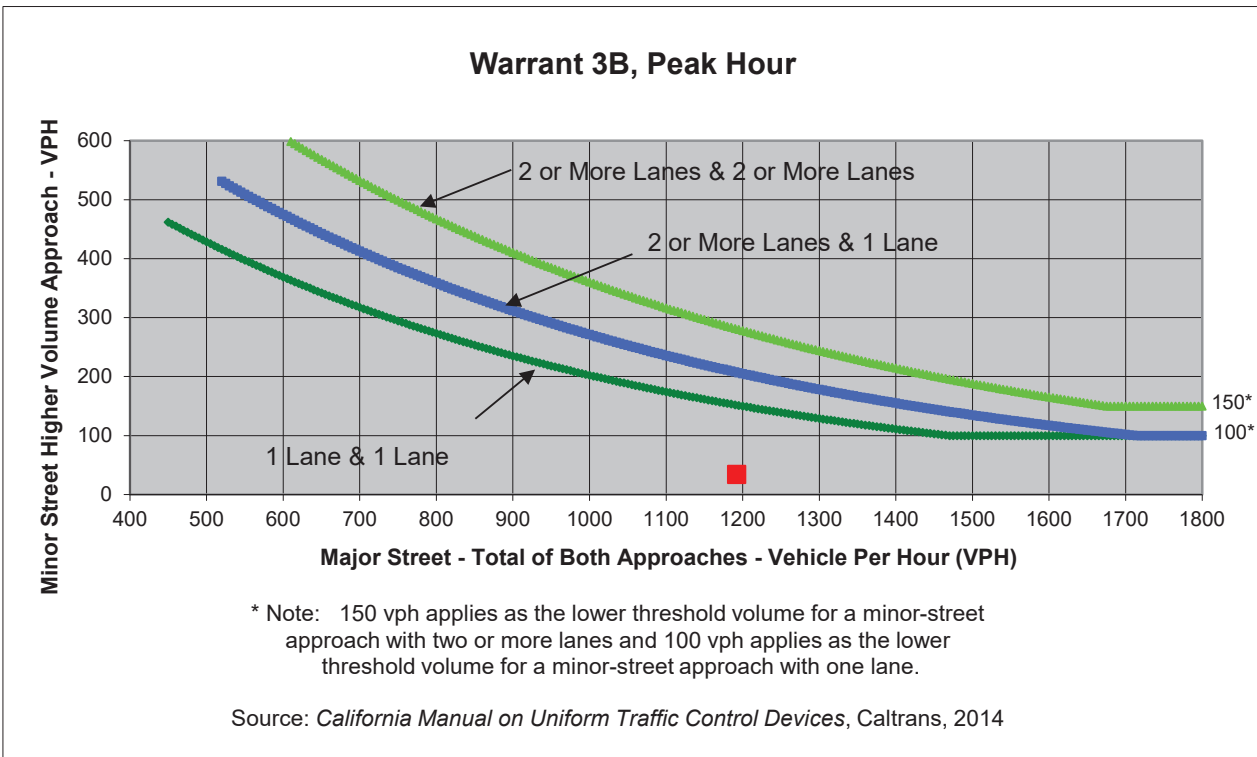

	Major Street	Minor Street	Warrant Met
	El Camino Av	Fairfield Av	
Number of Approach Lanes	1	1	<u>NO</u>
Traffic Volume (VPH) *	1,192	34	

* Note: Traffic Volume for Major Street is Total Volume of Both Approches.
 Traffic Volume for Minor Street is the Volume of High Volume Approach.



Major Street El Camino Av
 Minor Street Fairfield Av

Project Vision Zero Top 5 Corridors
 Scenario El Camino Av - VZ Recommendation
 Peak Hour PM

Turn Movement Volumes

	NB	SB	EB	WB
Left	3	5	13	21
Through	5	6	472	365
Right	17	22	9	6
Total	25	33	494	392

Major Street Direction

	North/South
x	East/West

Intersection Geometry

Number of Approach Lanes for Minor Street	1
Total Approaches	4

Worst Case Delay for Minor Street

Stopped Delay (seconds per vehicle)	15.9
Approach with Worst Case Delay	NB
Total Vehicles on Approach	25

Warrant 3A, Peak Hour			
	Peak Hour Delay on Minor Approach (vehicle-hours)	Peak Hour Volume on Minor Approach (vph)	Peak Hour Entering Volume Serviced (vph)
Camino Av - VZ Recommendation	0.1	33	944
Limiting Value	4	100	800
Condition Satisfied?	Not Met	Not Met	Met
Warrant Met	<u>NO</u>		



Major Street **El Camino Av**
 Minor Street **Fairfield Av**

Project **Vision Zero Top 5 Corridors**
 Scenario **El Camino Av - VZ Recommendation**
 Peak Hour **PM**

Turn Movement Volumes

	NB	SB	EB	WB
Left	3	5	13	21
Through	5	6	472	365
Right	17	22	9	6
Total	25	33	494	392

Major Street Direction

North/South
x East/West

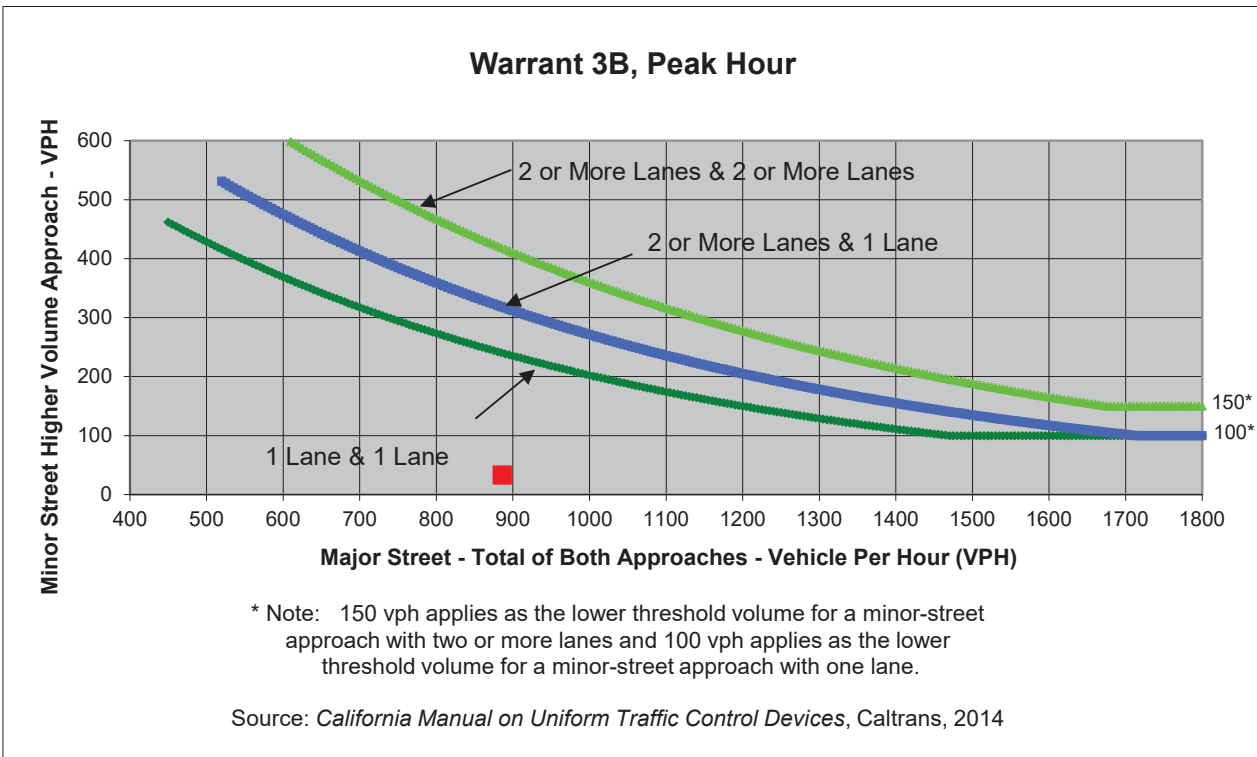

	Major Street	Minor Street	Warrant Met
	El Camino Av	Fairfield Av	
Number of Approach Lanes	1	1	<u>NO</u>
Traffic Volume (VPH) *	886	33	

* Note: Traffic Volume for Major Street is Total Volume of Both Approches.
 Traffic Volume for Minor Street is the Volume of High Volume Approach.



Major Street El Camino Av
 Minor Street Fairfield Av

Project Vision Zero Top 5 Corridors
 Scenario El Camino Av - VZ Recommendation
 Peak Hour PM

Turn Movement Volumes

	NB	SB	EB	WB
Left	15	0	9	7
Through	9	3	562	566
Right	62	11	20	38
Total	86	14	591	611

Major Street Direction

	North/South
x	East/West

Intersection Geometry

Number of Approach Lanes for Minor Street	1
Total Approaches	4

Worst Case Delay for Minor Street

Stopped Delay (seconds per vehicle)	21.6
Approach with Worst Case Delay	NB
Total Vehicles on Approach	86

Warrant 3A, Peak Hour			
	Peak Hour Delay on Minor Approach (vehicle-hours)	Peak Hour Volume on Minor Approach (vph)	Peak Hour Entering Volume Serviced (vph)
Camino Av - VZ Recommendation	0.5	86	1,302
Limiting Value	4	100	800
Condition Satisfied?	Not Met	Not Met	Met
Warrant Met	<u>NO</u>		



Major Street El Camino Av
 Minor Street Fairfield Av

Project Vision Zero Top 5 Corridors
 Scenario El Camino Av - VZ Recommendation
 Peak Hour AM

Turn Movement Volumes

	NB	SB	EB	WB
Left	7	4	5	9
Through	3	2	473	389
Right	15	3	17	12
Total	25	9	495	410

Major Street Direction

	North/South
x	East/West

Intersection Geometry

Number of Approach Lanes for Minor Street	1
Total Approaches	4

Worst Case Delay for Minor Street

Stopped Delay (seconds per vehicle)	18.6
Approach with Worst Case Delay	SB
Total Vehicles on Approach	9

Warrant 3A, Peak Hour			
	Peak Hour Delay on Minor Approach (vehicle-hours)	Peak Hour Volume on Minor Approach (vph)	Peak Hour Entering Volume Serviced (vph)
Camino Av - VZ Recommendation	0	25	939
Limiting Value	4	100	800
Condition Satisfied?	Not Met	Not Met	Met
Warrant Met	<u>NO</u>		



Major Street **El Camino Av**
 Minor Street **Fairfield Av**

Project **Vision Zero Top 5 Corridors**
 Scenario **El Camino Av - VZ Recommendation**
 Peak Hour **AM**

Turn Movement Volumes

	NB	SB	EB	WB
Left	7	4	5	9
Through	3	2	473	389
Right	15	3	17	12
Total	25	9	495	410

Major Street Direction

North/South
x East/West

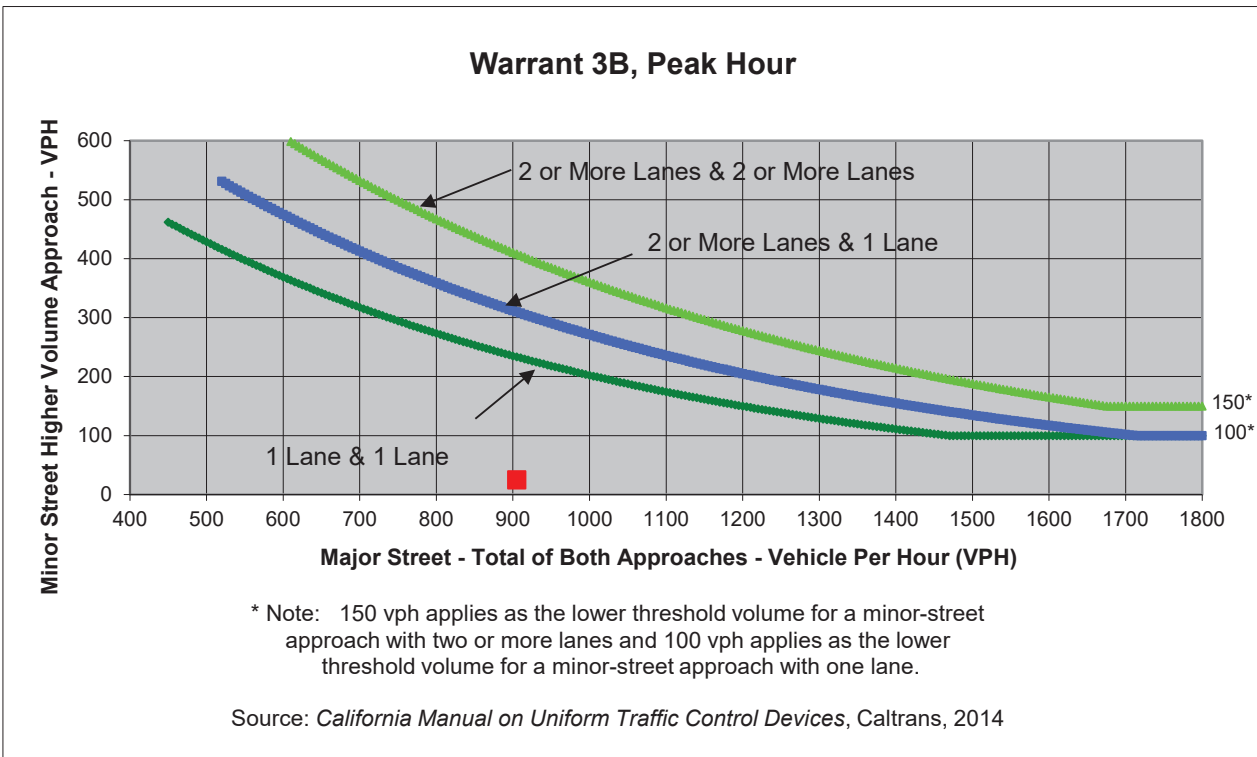

	Major Street	Minor Street	Warrant Met
	El Camino Av	Fairfield Av	
Number of Approach Lanes	1	1	<u>NO</u>
Traffic Volume (VPH) *	905	25	

* Note: Traffic Volume for Major Street is Total Volume of Both Approches.
 Traffic Volume for Minor Street is the Volume of High Volume Approach.

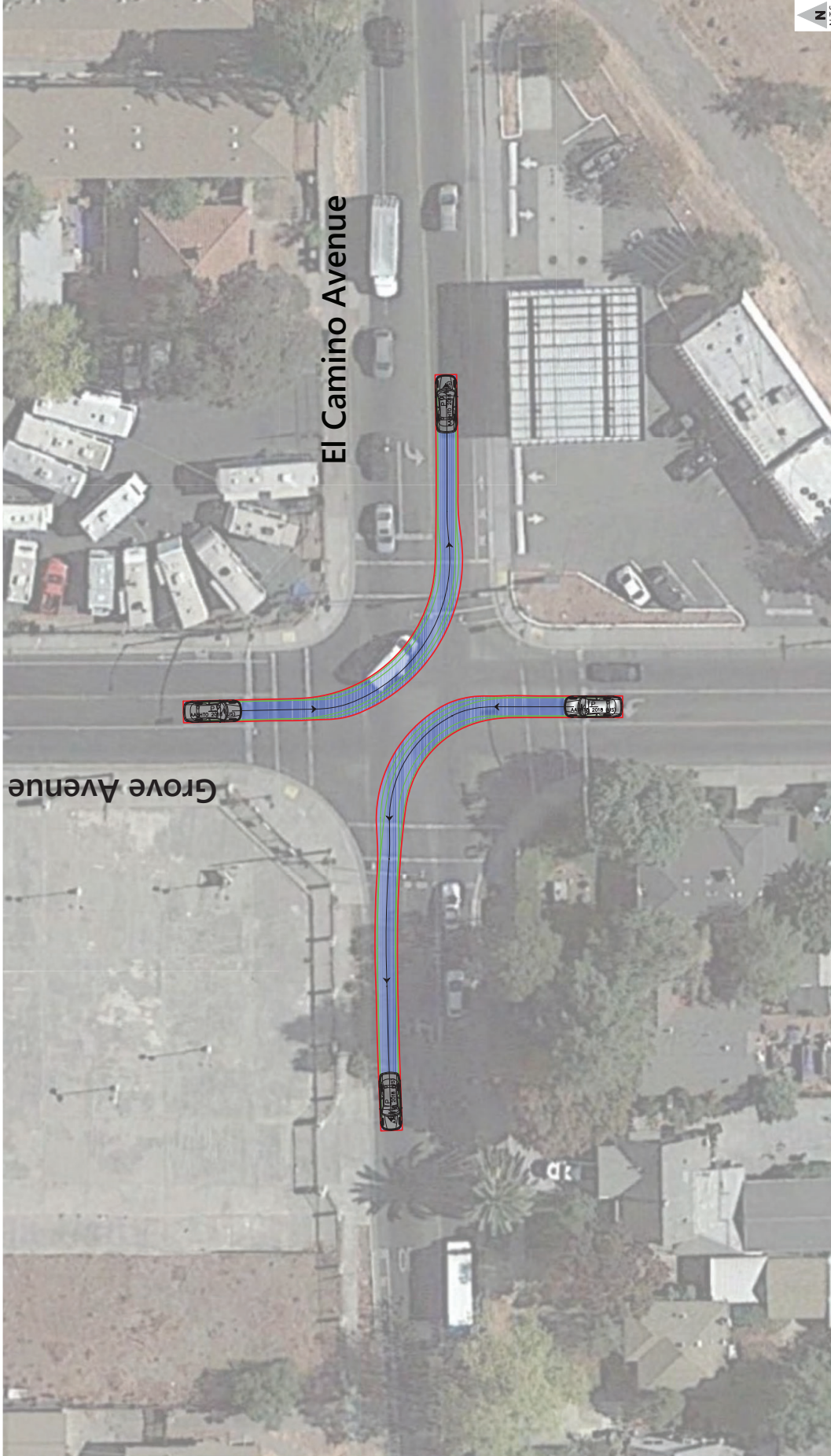

Legend:

- Vehicle Wheel
- Vehicle Body
- Vehicle Center
- Vehicle Swept Path

CONCEPTUAL - NOT FOR CONSTRUCTION. ADDITIONAL DETAILED ANALYSIS AND ENGINEERING DESIGN REQUIRED.



Turning Template
Passenger Car

El Camino Ave / Grove Ave - Northbound / Southbound Left Turns

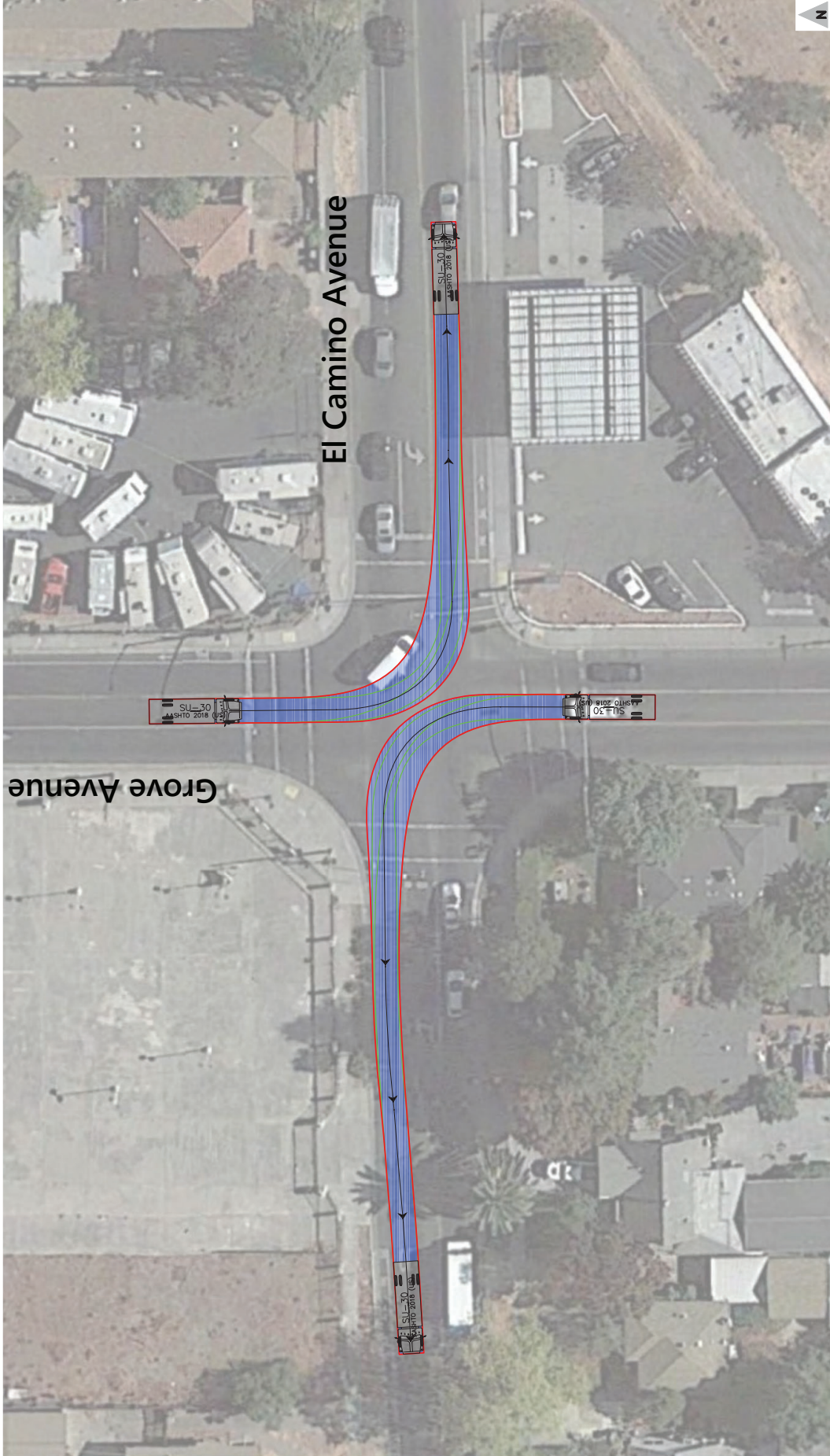

Legend:

- Vehicle Wheel
- Vehicle Body
- Vehicle Center
- Vehicle Sweep Path

CONCEPTUAL - NOT FOR CONSTRUCTION. ADDITIONAL DETAILED ANALYSIS AND ENGINEERING DESIGN REQUIRED.



Turning Template
30° Single Unit Truck

El Camino Ave / Grove Ave - Northbound / Southbound Left Turns

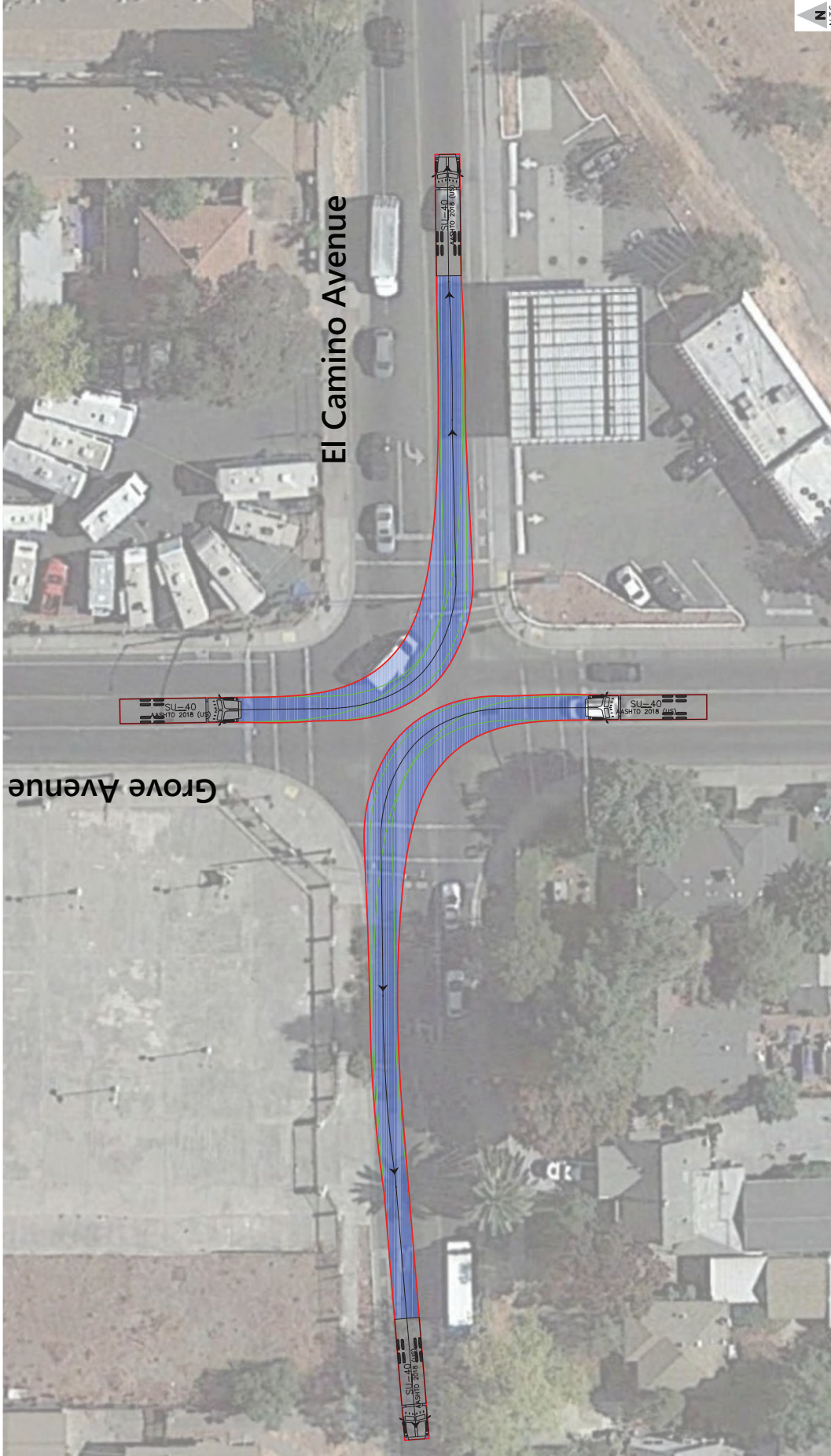

Legend:

- Vehicle Wheel
- Vehicle Body
- Vehicle Center
- Vehicle Swept Path

CONCEPTUAL - NOT FOR CONSTRUCTION. ADDITIONAL DETAILED ANALYSIS AND ENGINEERING DESIGN REQUIRED.

Turning Template
40' Single Unit Truck
El Camino Ave / Grove Ave - Northbound / Southbound Left Turns



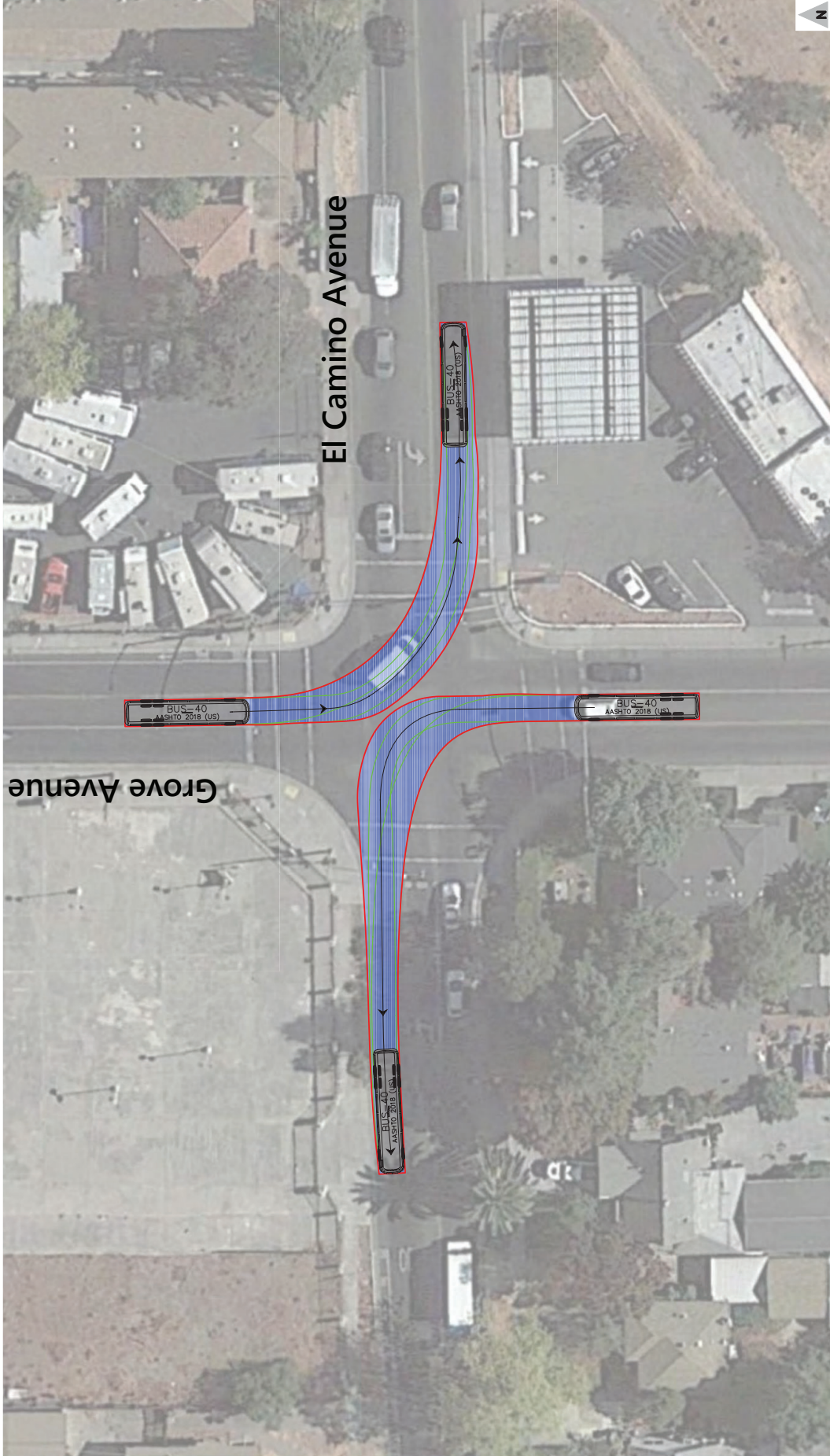

Legend:

- Vehicle Wheel
- Vehicle Body
- Vehicle Center
- Vehicle Swept Path

CONCEPTUAL - NOT FOR CONSTRUCTION. ADDITIONAL DETAILED ANALYSIS AND ENGINEERING DESIGN REQUIRED.

Turning Template

40' Bus

El Camino Ave / Grove Ave - Northbound / Southbound Left Turns



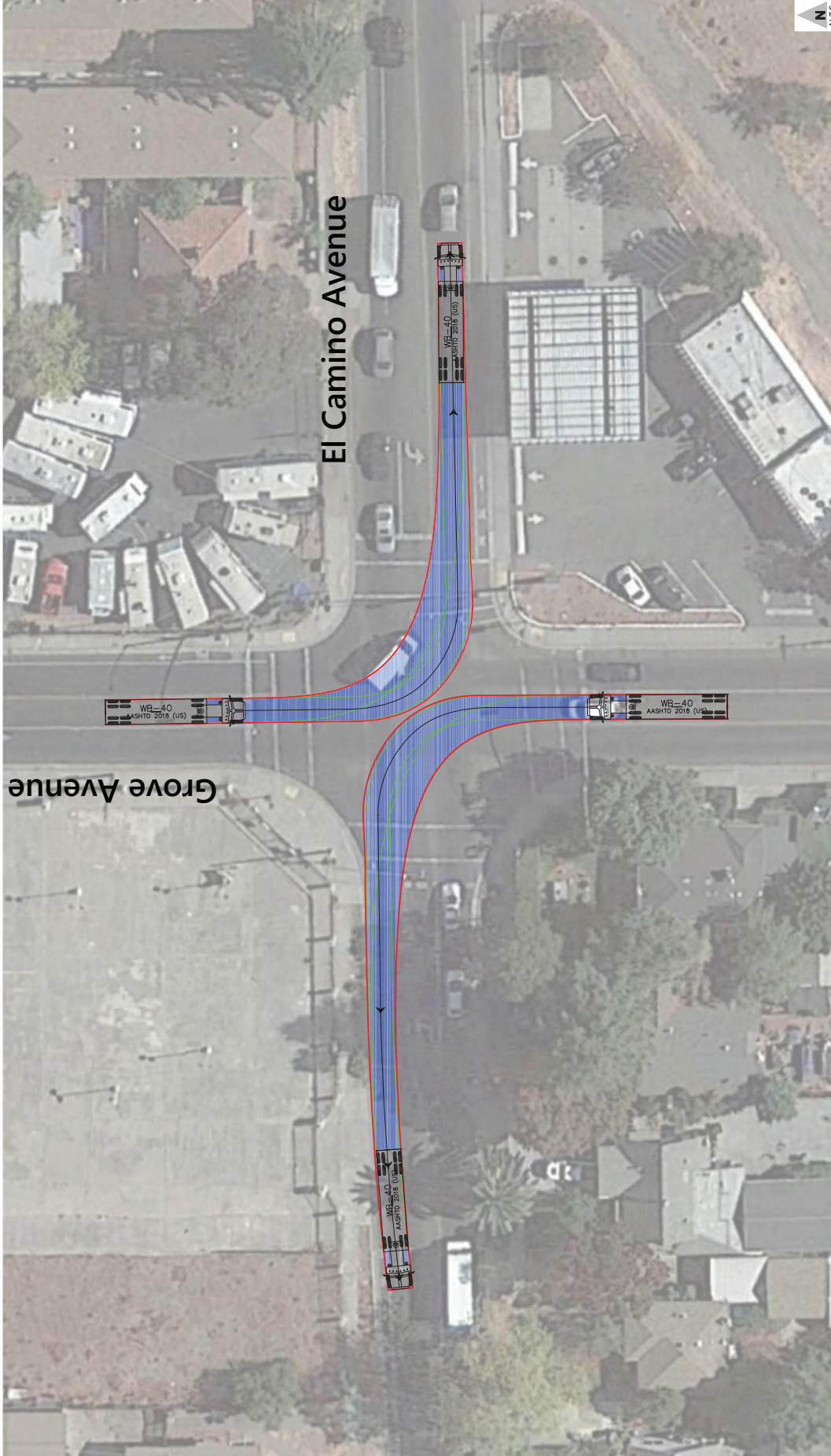

Legend:

- Vehicle Wheel
- Vehicle Body
- Vehicle Center
- Vehicle Swept Path

CONCEPTUAL - NOT FOR CONSTRUCTION. ADDITIONAL DETAILED ANALYSIS AND ENGINEERING DESIGN REQUIRED.



Turning Template
 Intermediate Semi-Trailer WB-40
 El Camino Ave / Grove Ave - Northbound / Southbound Left Turns

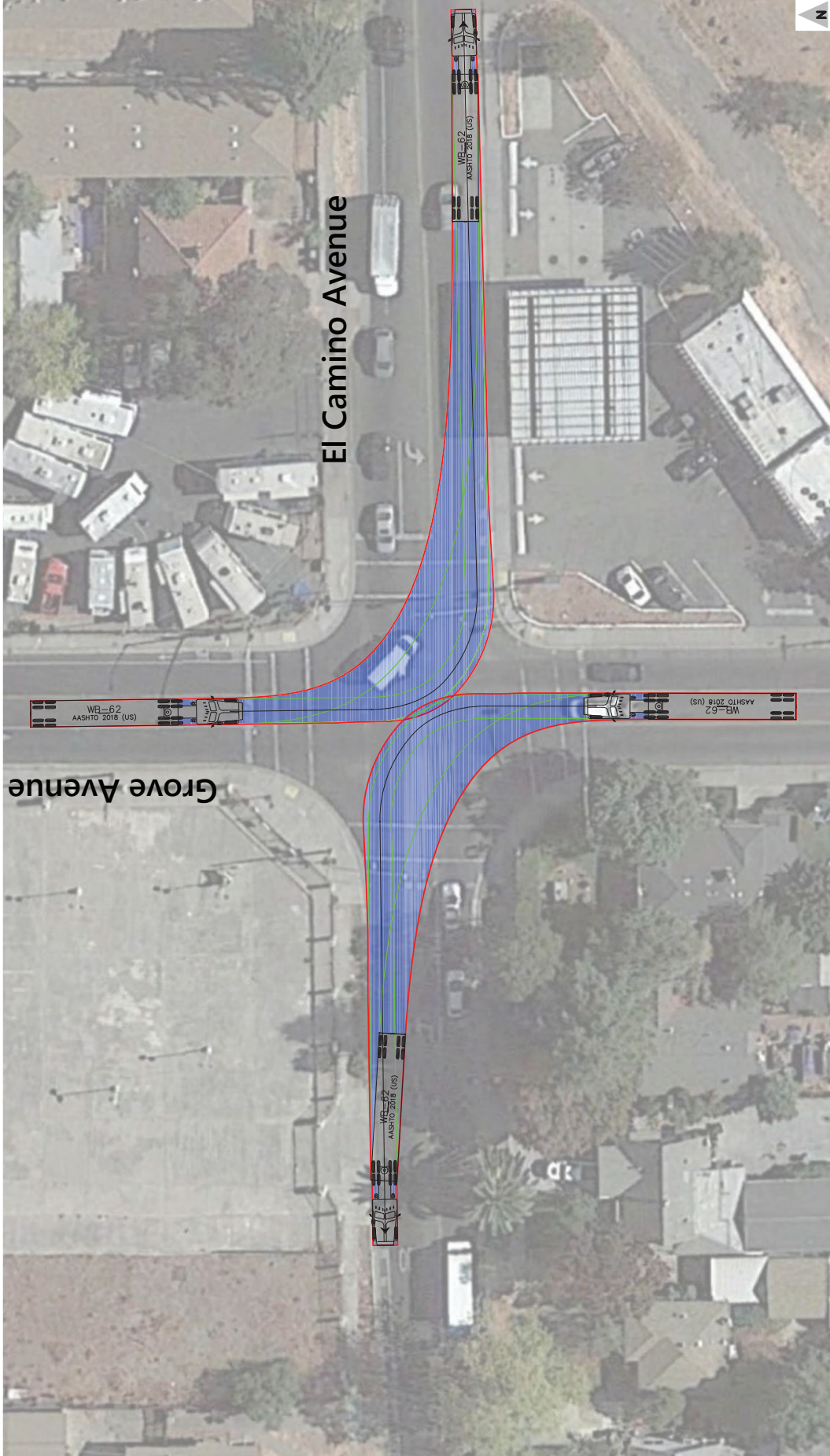

Legend:

- Vehicle Wheel
- Vehicle Body
- Vehicle Center
- Vehicle Swept Path

CONCEPTUAL - NOT FOR CONSTRUCTION. ADDITIONAL DETAILED ANALYSIS AND ENGINEERING DESIGN REQUIRED.



Turning Template
Intermediate Semi-Trailer WB-62
El Camino Ave / Grove Ave - Northbound / Southbound Left Turns

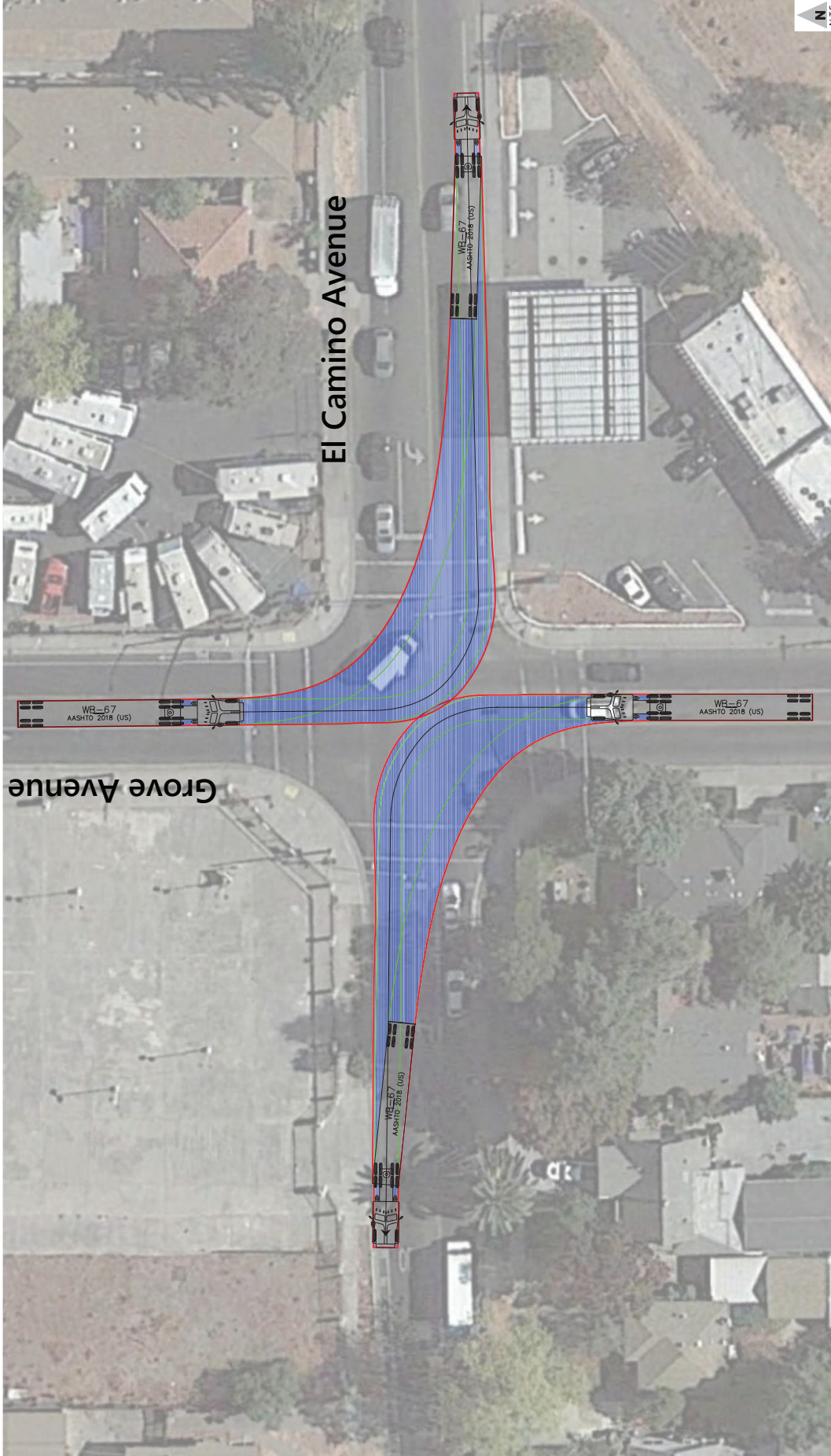

Legend:

- Vehicle Wheel
- Vehicle Body
- Vehicle Center
- Vehicle Swept Path

CONCEPTUAL - NOT FOR CONSTRUCTION. ADDITIONAL DETAILED ANALYSIS AND ENGINEERING DESIGN REQUIRED.



El Camino Avenue

Grove Avenue

Turning Template
Intermediate Semi-Trailer WB-67
El Camino Ave / Grove Ave - Northbound / Southbound Left Turns

Marysville Boulevard

Vision Zero Top 5 Corridor Recommendations Results Summary – Marysville Boulevard

Vision Zero Top 5 Corridor Recommendations Implemented

- Signal coordination
- Road diet on Marysville Blvd and Del Paso Boulevard between I-80 and El Camino Avenue
- New traffic signals at Marysville Blvd / Harris Ave and Marysville Blvd / Rosalind St
- Clearance time extended at all signalized intersections
- Protected left-turns at Marysville Blvd / Los Robles Blvd (S) and Marysville Blvd / Arcade Blvd. Split phasing at Marysville Blvd / North Avenue
- Marysville Blvd/Ermina Drive restricted to right-in/right-out access only

Speed & Travel Time Results

Travel Times (min)	Dir	Existing Conditions		VZ Recommendations		% Change	
		AM Peak Hour	PM Peak Hour	AM Peak Hour	PM Peak Hour	AM Peak Hour	PM Peak Hour
Marysville Blvd – North Ave to Arcade Blvd	NB	3.2	3.7	4.1	5.5	27%	49%
	SB	3.6	3.6	5.5	4.5	51%	27%
Speed (mph)	Dir	Existing Conditions		VZ Recommendations		% Change	
		AM Peak Hour	PM Peak Hour	AM Peak Hour	PM Peak Hour	AM Peak Hour	PM Peak Hour
Marysville Blvd – North Ave to Arcade Blvd	NB	20	18	16	12	-20%	-33%
	SB	18	18	12	15	-33%	-17%

Delay & LOS Results

Intersection	Existing Conditions		VZ Recommendations			
	Control ¹	AM Peak Hour	PM Peak Hour	Control	AM Peak Hour	PM Peak Hour
Marysville Blvd / North Ave	Signal	A / 10	B / 11	Signal	B / 19	C / 23
Marysville Blvd / Harris Ave	SSSC	A (C) / 3 (23)	A (D) / 4 (25)	Signal	B / 16	D / 40
Marysville Blvd / Grand Ave	Signal	C / 21	B / 20	Signal	D / 51	E / 66
Marysville Blvd / Roanoke Ave	SSSC	A (C) / 6 (16)	C (F) / 22 (69)	SSSC	A (D) / 9 (32)	D (F) / 33 (204)
Marysville Blvd / South Ave	Signal	B / 14	B / 10	Signal	D / 42	C / 26
Marysville Blvd / Rosalind St	SSSC	<i>Not Analyzed</i>		Signal	A / 5	B / 12
Marysville Blvd / Los Robles Blvd (N)	SSSC	A (C) / 2 (22)	A (B) / 2 (13)	SSSC	A (E) / 5 (44)	A (C) / 5 (19)
Marysville Blvd / Los Robles Blvd (S)	Signal	A / 5	A / 6	Signal	B / 11	B / 15
Marysville Blvd / Arcade Blvd	Signal	C / 31	D / 42	Signal	C / 34	D / 46

Vision Zero Top 5 Corridor Recommendations Results Summary – Marysville Boulevard

Peak Hour Maximum Queue Results

Intersection	Approach	Lane	Storage (ft)	Peak Hour Maximum Queue (ft)	
				AM Peak Hour	PM Peak Hour
Marysville Boulevard/North Avenue	SB	Left	125	150	100
		Through	475	200	225
		Through/Right	475	225	225
	NB	Left	125	100	50
		Through/Right	2,800	575	600
Marysville Boulevard/Arcade Boulevard	SB	Left	750	325	525
		Through	1,200	275	175
		Right	200	75	175
	EB	Left	150	100	100
		Through/Right	3,800	225	200
		Left	125	75	150
	WB	Through	1,725	250	600
		Right	125	175	175

Arterial Level of Service
Existing Conditions

AM Peak Hour
Vision Zero - Top 5 Corridors

Arterial Level of Service: NB Marysville BI

Cross Street	Node	Delay (s/veh)	Travel time (s)	Dist (mi)	Arterial Speed
Del Paso Blvd	11	5.0	25.5	0.2	29
Acacia Av	109	1.6	25.1	0.2	34
PED CROSSING	501	4.6	18.7	0.1	27
Sonoma Av	10	1.1	7.3	0.1	31
Strader Av	122	0.7	7.8	0.1	31
Arcade Bl	8	37.2	42.3	0.1	4
Ermina Dr	124	3.1	12.3	0.1	27
Los Robles BI (S)	7	3.6	19.8	0.2	29
Los Robles BI (N)	6	1.3	10.7	0.1	31
	142	0.2	2.7	0.0	29
Rosalind St	123	0.4	5.0	0.0	34
South Av	5	9.5	22.7	0.1	21
Roanoke Av	4	4.0	16.8	0.1	27
HAWK	502	0.7	2.1	0.0	20
Grand Av	3	11.3	22.6	0.1	18
Harris Av	2	2.2	15.1	0.1	30
North Av	1	9.1	21.5	0.1	21
Total		95.7	277.8	1.8	23

Arterial Level of Service: SB Marysville BI

Cross Street	Node	Delay (s/veh)	Travel time (s)	Dist (mi)	Arterial Speed
North Av	1	8.4	36.6	0.3	28
Harris Av	2	2.8	15.5	0.1	29
Grand Av	3	22.7	35.4	0.1	13
HAWK	502	7.1	18.8	0.1	22
Roanoke Av	4	0.4	1.5	0.0	28
South Av	5	13.7	26.3	0.1	17
Rosalind St	123	3.3	16.3	0.1	28
	142	0.7	5.6	0.0	30
Los Robles BI (N)	6	0.4	2.6	0.0	31
	7	4.7	14.1	0.1	24
Ermina Dr	124	5.6	21.8	0.2	26
Arcade Bl	8	13.0	22.2	0.1	15
Strader Av	122	1.7	7.0	0.1	27
Sonoma Av	10	1.0	8.0	0.1	30
PED CROSSING	501	4.9	11.6	0.1	19
Acacia Av	109	2.2	15.9	0.1	32
Del Paso Blvd	11	5.0	27.9	0.2	31
Total		97.4	287.1	1.9	24

Arterial Level of Service: NB Marysville BI

Cross Street	Node	Delay (s/veh)	Travel time (s)	Dist (mi)	Arterial Speed
Del Paso Blvd	11	5.8	26.5	0.2	28
Acacia Av	109	2.1	25.7	0.2	33
PED CROSSING	501	3.2	17.6	0.1	29
Sonoma Av	10	1.2	7.4	0.1	30
Strader Av	122	4.5	11.5	0.1	21
Arcade BI	8	32.9	37.9	0.1	5
Ermina Dr	124	3.6	13.0	0.1	25
Los Robles BI (S)	7	6.3	22.4	0.2	26
Los Robles BI (N)	6	2.1	11.5	0.1	29
	142	0.3	2.8	0.0	28
Rosalind St	123	0.6	5.2	0.0	32
South Av	5	8.6	21.7	0.1	21
Roanoke Av	4	20.1	32.8	0.1	14
HAWK	502	3.0	4.4	0.0	9
Grand Av	3	18.7	29.9	0.1	14
Harris Av	2	3.3	16.4	0.1	28
North Av	1	9.7	22.2	0.1	20
Total		125.9	308.9	1.8	21

Arterial Level of Service: SB Marysville BI

Cross Street	Node	Delay (s/veh)	Travel time (s)	Dist (mi)	Arterial Speed
North Av	1	9.1	37.5	0.3	28
Harris Av	2	2.7	15.4	0.1	29
Grand Av	3	17.1	29.9	0.1	15
HAWK	502	18.7	30.2	0.1	14
Roanoke Av	4	1.7	2.8	0.0	15
South Av	5	8.9	21.8	0.1	21
Rosalind St	123	2.2	15.4	0.1	30
	142	0.6	5.6	0.0	30
Los Robles BI (N)	6	0.4	2.6	0.0	31
	7	4.5	13.9	0.1	24
Ermina Dr	124	2.4	18.3	0.2	31
Arcade BI	8	12.5	21.5	0.1	15
Strader Av	122	1.3	6.7	0.1	28
Sonoma Av	10	0.6	7.7	0.1	31
PED CROSSING	501	2.4	9.0	0.1	25
Acacia Av	109	1.0	14.8	0.1	34
Del Paso Blvd	11	4.5	27.5	0.2	31
Total		90.7	280.5	1.9	24

Arterial Level of Service: NB Marysville BI

Cross Street	Node	Delay (s/veh)	Travel time (s)	Dist (mi)	Arterial Speed
Del Paso Blvd	11	7.6	29.6	0.2	26
Acacia Av	109	1.9	25.4	0.2	34
PED CROSSING	501	4.0	18.4	0.1	27
Sonoma Av	10	1.4	7.6	0.1	29
Strader Av	122	13.6	20.6	0.1	12
Arcade BI	8	56.0	60.9	0.1	3
	124	3.8	13.0	0.1	25
Los Robles BI (S)	7	4.2	20.4	0.2	28
Los Robles BI (N)	6	1.6	11.1	0.1	30
	142	0.5	3.0	0.0	26
Rosalind St	123	1.0	5.6	0.0	30
Nogales St	152	0.9	4.3	0.0	27
South Av	5	17.1	27.1	0.1	13
Roanoke Av	4	4.4	17.2	0.1	26
HAWK	502	0.8	2.2	0.0	19
Grand Av	3	18.1	29.1	0.1	14
Harris Av	2	7.1	20.2	0.1	23
	158	6.3	15.2	0.1	20
North Av	1	11.7	15.5	0.0	9
Total		162.0	346.5	1.8	19

Arterial Level of Service: SB Marysville Bl

Cross Street	Node	Delay (s/veh)	Travel time (s)	Dist (mi)	Arterial Speed
North Av	1	43.0	70.9	0.3	15
	158	14.9	18.9	0.0	7
Harris Av	2	27.7	36.2	0.1	8
Grand Av	3	51.1	63.5	0.1	7
HAWK	502	8.0	19.7	0.1	21
Roanoke Av	4	0.7	1.8	0.0	24
South Av	5	19.5	31.6	0.1	14
Nogales St	152	4.3	14.0	0.1	25
Rosalind St	123	1.2	4.3	0.0	27
	142	2.2	7.2	0.0	23
Los Robles Bl (N)	6	1.3	3.5	0.0	23
	7	10.4	19.8	0.1	17
Ermina Dr	124	3.5	19.6	0.2	29
Arcade Bl	8	7.5	16.6	0.1	20
	122	1.6	7.3	0.1	25
Sonoma Av	10	1.8	8.8	0.1	28
PED CROSSING	501	3.3	9.9	0.1	23
Acacia Av	109	3.6	17.4	0.1	29
Del Paso Blvd	11	9.2	32.8	0.2	26
Total		214.8	403.7	1.9	17

Arterial Level of Service: NB Marysville BI

Cross Street	Node	Delay (s/veh)	Travel time (s)	Dist (mi)	Arterial Speed
Del Paso Blvd	11	8.7	30.4	0.2	26
Acacia Av	109	2.1	26.0	0.2	33
PED CROSSING	501	4.7	19.1	0.1	26
Sonoma Av	10	2.3	8.4	0.1	27
Strader Av	122	8.5	15.5	0.1	16
Arcade BI	8	20.0	25.2	0.1	7
	124	4.1	13.3	0.1	25
Los Robles BI (S)	7	15.9	32.1	0.2	18
Los Robles BI (N)	6	6.5	15.8	0.1	21
	142	2.6	5.0	0.0	16
Rosalind St	123	6.7	11.2	0.0	15
Nogales St	152	3.5	6.8	0.0	17
South Av	5	21.6	31.2	0.1	11
Roanoke Av	4	38.6	51.3	0.1	9
HAWK	502	4.4	5.8	0.0	7
Grand Av	3	40.7	51.9	0.1	8
Harris Av	2	40.2	52.5	0.1	9
	158	5.6	14.5	0.1	21
North Av	1	7.1	10.9	0.0	13
Total		243.9	426.9	1.8	15

Arterial Level of Service: SB Marysville Bl

Cross Street	Node	Delay (s/veh)	Travel time (s)	Dist (mi)	Arterial Speed
North Av	1	18.2	46.5	0.3	22
	158	9.0	12.9	0.0	11
Harris Av	2	25.5	34.1	0.1	9
Grand Av	3	28.9	41.5	0.1	11
HAWK	502	15.5	26.9	0.1	15
Roanoke Av	4	0.9	1.9	0.0	22
South Av	5	13.8	26.3	0.1	17
Nogales St	152	4.3	14.1	0.1	25
Rosalind St	123	1.8	5.2	0.0	22
	142	1.6	6.4	0.0	26
Los Robles Bl (N)	6	1.0	3.2	0.0	25
	7	7.0	16.5	0.1	20
Ermina Dr	124	6.4	22.7	0.2	25
Arcade Bl	8	5.1	14.3	0.1	23
Strader Av	122	1.0	6.7	0.1	28
Sonoma Av	10	0.7	7.7	0.1	32
PED CROSSING	501	2.0	8.6	0.1	26
Acacia Av	109	1.3	15.0	0.1	34
Del Paso Blvd	11	2.8	26.3	0.2	32
Total		146.9	336.9	1.9	20

SimTraffic Post-Processor
Average Results from 10 Runs
Volume and Delay by Movement

Vision Zero Top 5 Corridors - Marysville Bl
Marysville Blvd Road Diet
AM Peak Hour

Intersection 1 Marysville Bl/North Av Signal

Direction	Movement	Demand Volume (vph)	Served Volume (vph)		Total Delay (sec/veh)		LOS
			Average	Percent	Average	Std. Dev.	
NB	Left Turn	15	12	79.4%	60.4	26.0	E
	Through	593	525	88.5%	11.6	2.0	B
	Right Turn	6	6	93.0%	5.1	2.2	A
	Subtotal	614	542	88.3%	12.6	2.1	B
SB	Left Turn	47	39	82.3%	63.0	14.1	E
	Through	813	782	96.1%	12.2	5.1	B
	Right Turn	41	39	96.2%	5.5	4.6	A
	Subtotal	901	860	95.4%	14.2	5.0	B
EB	Left Turn	105	100	95.3%	56.5	5.3	E
	Through	27	26	97.8%	57.6	17.5	E
	Right Turn	27	26	97.8%	40.7	13.8	D
	Subtotal	159	153	96.2%	54.0	7.2	D
WB	Left Turn	18	16	90.9%	47.0	17.3	D
	Through	24	28	116.3%	57.1	18.7	E
	Right Turn	12	11	93.0%	9.5	7.3	A
	Subtotal	54	55	102.6%	46.9	8.4	D
Total		1,728	1,610	93.2%	18.6	2.9	B

Intersection 2 Marysville Bl/Harris Av Signal

Direction	Movement	Demand Volume (vph)	Served Volume (vph)		Total Delay (sec/veh)		LOS
			Average	Percent	Average	Std. Dev.	
NB	Left Turn	29	24	82.1%	65.7	15.6	E
	Through	565	508	89.9%	8.3	2.2	A
	Right Turn	3	1	49.6%	0.4	0.8	A
	Subtotal	597	533	89.4%	10.9	2.9	B
SB	Left Turn	35	39	111.6%	59.6	12.1	E
	Through	798	776	97.2%	13.7	10.7	B
	Right Turn	25	25	98.2%	13.5	13.9	B
	Subtotal	858	839	97.8%	15.6	10.3	B
EB	Left Turn	24	26	107.0%	69.0	26.6	E
	Through	11	13	118.4%	56.6	21.4	E
	Right Turn	43	38	87.4%	43.6	21.9	D
	Subtotal	78	76	97.8%	55.5	22.3	E
WB	Left Turn	4	4	102.3%	55.4	51.6	E
	Through	3	3	111.6%	76.1	78.4	E
	Right Turn	23	26	114.8%	18.2	23.6	B
	Subtotal	30	34	112.8%	28.8	19.0	C
Total		1,563	1,483	94.9%	16.2	6.5	B

SimTraffic Post-Processor
Average Results from 10 Runs
Volume and Delay by Movement

Vision Zero Top 5 Corridors - Marysville Bl
Marysville Blvd Road Diet
AM Peak Hour

Intersection 3 Marysville Bl/Grand Av Signal

Direction	Movement	Demand Volume (vph)	Served Volume (vph)		Total Delay (sec/veh)		
			Average	Percent	Average	Std. Dev.	LOS
NB	Left Turn	136	118	86.4%	81.7	14.1	F
	Through	462	437	94.7%	25.0	2.7	C
	Right Turn	23	19	82.5%	22.0	10.4	C
	Subtotal	621	574	92.4%	36.6	3.5	D
SB	Left Turn	16	21	130.2%	75.6	16.5	E
	Through	755	719	95.2%	28.9	11.3	C
	Right Turn	73	62	85.6%	24.6	13.3	C
	Subtotal	844	802	95.1%	29.8	11.2	C
EB	Left Turn	91	81	89.5%	148.3	42.9	F
	Through	117	104	89.0%	98.9	42.9	F
	Right Turn	161	147	91.3%	80.9	42.7	F
	Subtotal	369	333	90.1%	103.6	44.2	F
WB	Left Turn	54	51	94.4%	101.7	32.0	F
	Through	162	155	95.8%	81.1	23.8	F
	Right Turn	44	35	80.3%	61.9	30.7	E
	Subtotal	260	241	92.9%	82.6	24.6	F
Total		2,094	1,950	93.1%	50.8	10.4	D

Intersection 4 Marysville Bl/Roanoke Av Side-street Stop

Direction	Movement	Demand Volume (vph)	Served Volume (vph)		Total Delay (sec/veh)		
			Average	Percent	Average	Std. Dev.	LOS
NB	Left Turn	13	10	77.3%	16.6	9.2	C
	Through	599	587	98.0%	5.3	1.9	A
	Right Turn	11	8	74.4%	3.6	1.5	A
	Subtotal	623	605	97.1%	5.5	1.9	A
SB	Left Turn	21	22	106.3%	17.2	5.8	C
	Through	939	888	94.6%	9.5	5.5	A
	Right Turn	10	8	81.8%	8.8	5.1	A
	Subtotal	970	918	94.7%	9.7	5.4	A
EB	Left Turn	1	0	37.2%	32.4	102.6	D
	Through	2	1	37.2%	10.6	26.4	B
	Right Turn	17	15	85.3%	28.2	26.5	D
	Subtotal	20	16	78.1%	33.5	39.2	D
WB	Left Turn	5	4	74.4%	19.4	16.8	C
	Through	1	1	111.6%	10.4	29.2	B
	Right Turn	20	17	85.6%	17.0	13.7	C
	Subtotal	26	22	84.4%	20.1	13.1	C
Total		1,639	1,561	95.3%	8.5	4.2	A

SimTraffic Post-Processor
Average Results from 10 Runs
Volume and Delay by Movement

Vision Zero Top 5 Corridors - Marysville BI
Marysville Blvd Road Diet
AM Peak Hour

Intersection 5 **Marysville BI/South Av** **Signal**

Direction	Movement	Demand Volume (vph)	Served Volume (vph)		Total Delay (sec/veh)		LOS
			Average	Percent	Average	Std. Dev.	
NB	Left Turn	74	68	92.5%	96.0	16.8	F
	Through	529	510	96.3%	21.1	3.8	C
	Right Turn	10	7	74.4%	10.7	11.1	B
	Subtotal	613	586	95.5%	30.0	7.3	C
SB	Left Turn	23	17	74.4%	91.3	21.4	F
	Through	905	852	94.2%	30.2	10.7	C
	Right Turn	33	36	108.2%	26.7	10.8	C
	Subtotal	961	905	94.2%	31.3	10.8	C
EB	Left Turn	36	31	84.7%	89.2	54.0	F
	Through	77	65	84.1%	95.5	70.4	F
	Right Turn	112	99	88.7%	84.5	58.2	F
	Subtotal	225	195	86.5%	88.6	59.8	F
WB	Left Turn	42	31	74.4%	93.4	59.8	F
	Through	88	76	86.7%	95.4	42.0	F
	Right Turn	58	51	88.5%	81.0	41.4	F
	Subtotal	188	159	84.5%	90.9	44.4	F
Total		1,987	1,844	92.8%	41.5	9.1	D

Intersection 6 **Marysville BI/Los Robles BI (N)** **Side-street Stop**

Direction	Movement	Demand Volume (vph)	Served Volume (vph)		Total Delay (sec/veh)		LOS
			Average	Percent	Average	Std. Dev.	
NB	Left Turn	30	28	91.8%	17.6	7.9	C
	Through	589	561	95.2%	1.6	0.3	A
	Right Turn						
	Subtotal	619	588	95.0%	2.3	0.6	A
SB	Left Turn						
	Through	1,075	977	90.8%	2.8	0.5	A
	Right Turn	19	18	95.9%	1.8	0.4	A
	Subtotal	1,094	995	90.9%	2.7	0.5	A
EB	Left Turn	31	25	81.6%	43.8	25.4	E
	Through						
	Right Turn	68	61	89.2%	40.3	20.1	E
	Subtotal	99	86	86.8%	41.3	20.6	E
WB	Left Turn						
	Through						
	Right Turn						
	Subtotal						
Total		1,812	1,669	92.1%	4.6	1.4	A

SimTraffic Post-Processor
Average Results from 10 Runs
Volume and Delay by Movement

Vision Zero Top 5 Corridors - Marysville BI
Marysville Blvd Road Diet
AM Peak Hour

Intersection 7 Marysville BI/Los Robles BI (S) Signal

Direction	Movement	Demand Volume (vph)	Served Volume (vph)		Total Delay (sec/veh)		
			Average	Percent	Average	Std. Dev.	LOS
NB	Left Turn	1	0	0.0%	0.0	0.0	A
	Through	586	562	95.9%	3.7	1.1	A
	Right Turn	9	5	57.9%	1.2	2.2	A
	Subtotal	596	567	95.2%	3.7	1.1	A
SB	Left Turn	43	47	109.9%	80.2	11.1	F
	Through	1,097	968	88.3%	9.4	1.8	A
	Right Turn	3	2	74.4%	3.8	1.8	A
	Subtotal	1,143	1,018	89.0%	12.7	2.0	B
EB	Left Turn	1	0	37.2%	9.8	30.9	A
	Through	1	0	37.2%	9.8	30.9	A
	Right Turn	1	0	37.2%	9.8	30.9	A
WB	Left Turn	49	50	102.5%	52.6	10.3	D
	Through	31	30	96.0%	26.3	14.0	C
	Right Turn	31	30	96.0%	26.3	14.0	C
	Subtotal	80	80	100.0%	42.5	9.2	D
Total		1,820	1,665	91.5%	11.1	1.7	B

Intersection 8 Marysville BI/Arcade BI Signal

Direction	Movement	Demand Volume (vph)	Served Volume (vph)		Total Delay (sec/veh)		
			Average	Percent	Average	Std. Dev.	LOS
NB	Left Turn	15	11	74.4%	91.0	57.3	F
	Through	243	244	100.6%	101.4	20.3	F
	Right Turn	32	28	87.2%	85.1	26.6	F
	Subtotal	290	283	97.7%	99.9	20.7	F
SB	Left Turn	543	459	84.5%	18.9	3.8	B
	Through	580	503	86.7%	10.5	1.5	B
	Right Turn	23	20	87.3%	5.2	1.6	A
	Subtotal	1,146	982	85.7%	14.4	2.2	B
EB	Left Turn	39	45	116.4%	59.4	13.6	E
	Through	119	105	87.8%	56.4	11.8	E
	Right Turn	32	35	110.4%	44.6	16.2	D
	Subtotal	190	185	97.5%	54.8	10.1	D
WB	Left Turn	28	33	116.9%	69.0	13.1	E
	Through	86	88	102.1%	55.0	8.5	E
	Right Turn	324	324	99.9%	11.8	3.2	B
	Subtotal	438	444	101.4%	24.7	3.5	C
Total		2,064	1,895	91.8%	33.5	2.7	C

SimTraffic Post-Processor
Average Results from 10 Runs
Volume and Delay by Movement

Vision Zero Top 5 Corridors - Marysville Bl
Marysville Blvd Road Diet
AM Peak Hour

Intersection 123 Marysville Blvd/Rosalind St Signal

Direction	Movement	Demand Volume (vph)	Served Volume (vph)		Total Delay (sec/veh)		
			Average	Percent	Average	Std. Dev.	LOS
NB	Left Turn						
	Through	609	575	94.4%	3.8	1.0	A
	Right Turn	11	13	118.4%	3.2	1.4	A
	Subtotal	620	588	94.9%	3.7	1.0	A
SB	Left Turn	12	10	83.7%	7.8	2.6	A
	Through	1,087	1,004	92.3%	4.7	0.9	A
	Right Turn						
	Subtotal	1,099	1,014	92.2%	4.8	0.9	A
EB	Left Turn						
	Through						
	Right Turn						
	Subtotal						
WB	Left Turn	7	4	63.8%	32.0	24.2	C
	Through						
	Right Turn	11	13	118.4%	8.1	6.7	A
	Subtotal	18	17	97.1%	16.0	10.1	B
Total		1,737	1,619	93.2%	4.5	0.8	A

SimTraffic Post-Processor
Average Results from 10 Runs
Volume and Delay by Movement

Vision Zero Top 5 Corridors - Marysville BI
Marysville Blvd Road Diet
PM Peak Hour

Intersection 1 Marysville BI/North Av Signal

Direction	Movement	Demand Volume (vph)	Served Volume (vph)		Total Delay (sec/veh)		
			Average	Percent	Average	Std. Dev.	LOS
NB	Left Turn	39	32	81.7%	48.3	7.7	D
	Through	865	661	76.4%	12.7	5.3	B
	Right Turn	10	5	53.8%	8.1	5.0	A
	Subtotal	914	698	76.4%	14.3	5.2	B
SB	Left Turn	41	35	84.3%	64.3	8.9	E
	Through	626	631	100.8%	17.7	7.8	B
	Right Turn	78	73	93.0%	8.5	6.1	A
	Subtotal	745	738	99.1%	19.1	7.2	B
EB	Left Turn	104	115	110.8%	61.5	24.8	E
	Through	18	22	119.5%	76.0	36.7	E
	Right Turn	49	51	105.0%	51.4	26.4	D
	Subtotal	171	188	110.0%	60.9	23.5	E
WB	Left Turn	16	20	122.4%	54.2	10.2	D
	Through	21	24	115.2%	49.8	9.7	D
	Right Turn	3	5	153.6%	6.0	7.1	A
	Subtotal	40	48	121.0%	46.9	5.7	D
Total		1,870	1,673	89.5%	22.8	6.8	C

Intersection 2 Marysville BI/Harris Av Signal

Direction	Movement	Demand Volume (vph)	Served Volume (vph)		Total Delay (sec/veh)		
			Average	Percent	Average	Std. Dev.	LOS
NB	Left Turn	61	53	86.9%	103.6	10.8	F
	Through	823	649	78.9%	41.1	8.9	D
	Right Turn	16	15	96.0%	38.4	24.0	D
	Subtotal	900	717	79.7%	45.7	9.3	D
SB	Left Turn	51	43	84.3%	82.3	28.3	F
	Through	606	608	100.3%	33.8	6.7	C
	Right Turn	34	38	111.8%	31.7	13.7	C
	Subtotal	691	689	99.7%	36.6	7.5	D
EB	Left Turn	31	27	86.7%	31.2	12.6	C
	Through	13	13	100.4%	17.1	16.5	B
	Right Turn	31	33	107.8%	21.3	7.9	C
	Subtotal	75	73	97.8%	23.9	7.2	C
WB	Left Turn	3	3	102.4%	7.9	11.1	A
	Through	8	7	86.4%	12.0	17.5	B
	Right Turn	58	41	71.5%	17.2	6.4	B
	Subtotal	69	51	74.6%	17.4	6.2	B
Total		1,735	1,531	88.2%	39.5	5.5	D

SimTraffic Post-Processor
Average Results from 10 Runs
Volume and Delay by Movement

Vision Zero Top 5 Corridors - Marysville BI
Marysville Blvd Road Diet
PM Peak Hour

Intersection 3 Marysville BI/Grand Av Signal

Direction	Movement	Demand Volume (vph)	Served Volume (vph)		Total Delay (sec/veh)		LOS
			Average	Percent	Average	Std. Dev.	
NB	Left Turn	170	132	77.9%	131.4	12.7	F
	Through	776	599	77.2%	84.1	10.0	F
	Right Turn	57	46	80.2%	79.1	7.2	E
	Subtotal	1,003	777	77.5%	92.0	9.5	F
SB	Left Turn	47	51	109.5%	69.6	19.2	E
	Through	513	518	101.1%	29.0	6.1	C
	Right Turn	80	76	95.5%	26.2	8.6	C
	Subtotal	640	646	101.0%	31.8	5.8	C
EB	Left Turn	61	53	86.9%	97.0	32.5	F
	Through	110	101	91.5%	56.6	25.3	E
	Right Turn	119	105	88.1%	41.4	22.5	D
	Subtotal	290	258	89.1%	59.1	24.8	E
WB	Left Turn	54	43	80.4%	108.8	32.5	F
	Through	167	161	96.6%	71.3	25.5	E
	Right Turn	64	61	94.8%	70.5	30.1	E
	Subtotal	285	265	93.1%	76.9	26.2	E
Total		2,218	1,947	87.8%	65.7	8.4	E

Intersection 4 Marysville BI/Roanoke Av Side-street Stop

Direction	Movement	Demand Volume (vph)	Served Volume (vph)		Total Delay (sec/veh)		LOS
			Average	Percent	Average	Std. Dev.	
NB	Left Turn	21	18	85.9%	39.8	15.2	E
	Through	963	801	83.1%	43.1	7.0	E
	Right Turn	30	20	65.3%	29.8	12.5	D
	Subtotal	1,014	838	82.7%	42.8	6.9	E
SB	Left Turn	22	19	85.5%	52.7	24.4	F
	Through	639	608	95.1%	16.1	3.4	C
	Right Turn	25	24	96.8%	15.3	3.3	C
	Subtotal	686	651	94.9%	17.1	3.7	C
EB	Left Turn	2	0	19.2%	86.4	173.0	F
	Through	1	2	153.6%	17.0	35.9	C
	Right Turn	25	27	107.5%	31.4	38.5	D
	Subtotal	28	29	102.9%	34.3	38.2	D
WB	Left Turn	14	5	38.4%	203.8	84.9	F
	Through	6	3	57.6%	192.0	167.7	F
	Right Turn	37	12	32.2%	194.6	53.3	F
	Subtotal	57	21	36.4%	158.0	89.8	F
Total		1,785	1,539	86.2%	33.3	4.6	D

SimTraffic Post-Processor
Average Results from 10 Runs
Volume and Delay by Movement

Vision Zero Top 5 Corridors - Marysville BI
Marysville Blvd Road Diet
PM Peak Hour

Intersection 5 Marysville BI/South Av Signal

Direction	Movement	Demand Volume (vph)	Served Volume (vph)		Total Delay (sec/veh)		
			Average	Percent	Average	Std. Dev.	LOS
NB	Left Turn	90	81	90.0%	79.3	6.8	E
	Through	944	814	86.2%	25.1	7.6	C
	Right Turn	21	19	91.4%	15.5	8.6	B
	Subtotal	1,055	914	86.6%	29.8	7.3	C
SB	Left Turn	19	18	97.0%	68.9	14.2	E
	Through	628	580	92.4%	13.7	3.8	B
	Right Turn	32	33	104.4%	11.2	5.3	B
	Subtotal	679	632	93.1%	15.2	4.3	B
EB	Left Turn	33	29	88.4%	51.3	13.7	D
	Through	38	36	94.0%	49.0	13.2	D
	Right Turn	47	51	108.7%	33.0	11.7	C
	Subtotal	118	116	98.3%	42.4	12.9	D
WB	Left Turn	10	10	99.8%	52.3	34.1	D
	Through	43	40	92.0%	48.7	15.5	D
	Right Turn	35	33	93.3%	32.6	8.0	C
	Subtotal	88	82	93.4%	43.1	8.8	D
Total		1,940	1,744	89.9%	26.2	4.7	C

Intersection 6 Marysville BI/Los Robles BI (N) Side-street Stop

Direction	Movement	Demand Volume (vph)	Served Volume (vph)		Total Delay (sec/veh)		
			Average	Percent	Average	Std. Dev.	LOS
NB	Left Turn	62	60	97.2%	12.4	2.9	B
	Through	1,063	993	93.4%	6.3	3.0	A
	Right Turn						
	Subtotal	1,125	1,053	93.6%	6.7	2.9	A
SB	Left Turn						
	Through	639	601	94.1%	1.0	0.2	A
	Right Turn	46	51	111.0%	0.1	0.1	A
	Subtotal	685	652	95.2%	0.9	0.2	A
EB	Left Turn	21	23	107.9%	18.8	11.5	C
	Through						
	Right Turn	62	63	102.2%	14.6	5.7	B
	Subtotal	83	86	103.6%	15.3	5.8	C
WB	Left Turn						
	Through						
	Right Turn						
	Subtotal						
Total		1,893	1,791	94.6%	5.0	1.7	A

SimTraffic Post-Processor
Average Results from 10 Runs
Volume and Delay by Movement

Vision Zero Top 5 Corridors - Marysville BI
Marysville Blvd Road Diet
PM Peak Hour

Intersection 7 Marysville BI/Los Robles BI (S) Signal

Direction	Movement	Demand Volume (vph)	Served Volume (vph)		Total Delay (sec/veh)		LOS
			Average	Percent	Average	Std. Dev.	
NB	Left Turn	2	2	76.8%	29.5	41.8	C
	Through	1,068	1,012	94.8%	15.8	6.8	B
	Right Turn	28	30	108.3%	13.2	12.0	B
	Subtotal	1,098	1,044	95.1%	15.8	6.9	B
SB	Left Turn	32	27	84.0%	67.8	12.3	E
	Through	650	610	93.9%	6.8	2.0	A
	Right Turn	19	18	97.0%	3.6	1.9	A
	Subtotal	701	655	93.5%	9.2	2.0	A
EB	Left Turn	19	18	97.0%	50.3	12.8	D
	Through	2	3	134.4%	36.2	42.3	D
	Right Turn	1	1	76.8%	0.8	2.4	A
	Subtotal	22	22	99.5%	49.8	18.0	D
WB	Left Turn	54	58	106.7%	46.7	8.9	D
	Through	3	2	76.8%	22.6	34.7	C
	Right Turn	38	42	110.1%	34.4	10.5	C
	Subtotal	95	102	107.1%	42.5	4.2	D
Total		1,916	1,823	95.2%	15.3	4.3	B

Intersection 8 Marysville BI/Arcade BI Signal

Direction	Movement	Demand Volume (vph)	Served Volume (vph)		Total Delay (sec/veh)		LOS
			Average	Percent	Average	Std. Dev.	
NB	Left Turn	9	8	89.6%	58.8	18.8	E
	Through	604	594	98.4%	30.5	4.9	C
	Right Turn	35	30	84.5%	27.6	7.0	C
	Subtotal	648	632	97.5%	30.6	4.7	C
SB	Left Turn	357	313	87.6%	91.4	18.2	F
	Through	317	287	90.6%	11.0	5.2	B
	Right Turn	30	27	89.6%	8.5	4.8	A
	Subtotal	704	627	89.0%	50.9	10.6	D
EB	Left Turn	39	33	84.7%	62.2	19.0	E
	Through	124	124	99.7%	45.4	7.8	D
	Right Turn	9	12	136.5%	42.6	26.4	D
	Subtotal	172	169	98.2%	48.6	9.1	D
WB	Left Turn	62	52	84.2%	97.8	15.4	F
	Through	183	184	100.5%	74.8	15.5	E
	Right Turn	472	464	98.4%	41.4	10.4	D
	Subtotal	717	700	97.7%	54.5	11.2	D
Total		2,241	2,128	94.9%	46.0	6.9	D

SimTraffic Post-Processor
Average Results from 10 Runs
Volume and Delay by Movement

Vision Zero Top 5 Corridors - Marysville Bl
Marysville Blvd Road Diet
PM Peak Hour

Intersection 123 Marysville Blvd/Rosalind St Signal

Direction	Movement	Demand Volume (vph)	Served Volume (vph)		Total Delay (sec/veh)		
			Average	Percent	Average	Std. Dev.	LOS
NB	Left Turn						
	Through	1,070	977	91.3%	15.6	6.7	B
	Right Turn	14	13	93.3%	17.5	24.0	B
	Subtotal	1,084	990	91.4%	15.6	6.7	B
SB	Left Turn	24	22	89.6%	27.4	13.2	C
	Through	673	642	95.4%	5.8	3.2	A
	Right Turn						
	Subtotal	697	664	95.2%	6.5	3.6	A
EB	Left Turn						
	Through						
	Right Turn						
	Subtotal						
WB	Left Turn	12	12	96.0%	32.8	14.2	C
	Through						
	Right Turn	14	13	90.5%	14.9	5.7	B
	Subtotal	26	24	93.0%	23.7	8.9	C
Total		1,807	1,678	92.9%	12.1	3.9	B

Intersection 1

Marysville BI/North Av

Signal

Direction	Lane Group	Storage (ft)	Average Queue (ft)		95th Queue (ft)		Maximum Queue (ft)		Block Time	
			Average	Std. Dev.	Average	Std. Dev.	Average	Std. Dev.	Pocket	Upstream
EB	Shared	1,050	150	15	250	32	250	35	0%	0%
NB	Left Turn	75	25	10	50	25	75	25	2%	0%
	Through/Right	575	200	32	275	34	300	36	18%	0%
SB	Left Turn	1,225	75	11	125	42	150	67	0%	0%
	Through	1,475	150	25	225	47	225	48	2%	0%
	Through/Right	1,475	125	27	225	49	200	46	0%	0%
WB	Left/Through	1,050	50	11	100	14	100	19	0%	0%
	Right Turn	175	25	6	50	14	50	18	0%	0%

SimTraffic Post-Processor
 Average Results from 10 Runs
 Queue Length
 Intersection 8

Marysville Bl/Arcade Bl

Vision Zero Top 5 Corridors - Marysville Bl
 Marysville Blvd Road Diet
 AM Peak Hour
 Signal

Direction	Lane Group	Storage (ft)	Average Queue (ft)		95th Queue (ft)		Maximum Queue (ft)		Block Time	
			Average	Std. Dev.	Average	Std. Dev.	Average	Std. Dev.	Pocket	Upstream
EB	Left Turn	150	50	17	100	39	100	41	0%	0%
	Through/Right	875	125	31	225	66	225	75	12%	0%
NB	Left Turn	125	25	16	75	53	100	65	0%	0%
	Through/Right	825	425	39	600	52	575	42	67%	1%
SB	Left Turn	375	200	42	325	57	325	55	0%	0%
	Through	750	150	15	275	33	275	39	1%	0%
	Right Turn	225	25	16	75	79	75	110	0%	0%
WB	Left Turn	125	25	15	75	37	75	48	0%	0%
	Through	925	125	43	225	91	250	94	7%	0%
	Right Turn	125	125	27	175	33	175	17	7%	0%

Intersection 1

Marysville BI/North Av

Signal

Direction	Lane Group	Storage (ft)	Average Queue (ft)		95th Queue (ft)		Maximum Queue (ft)		Block Time	
			Average	Std. Dev.	Average	Std. Dev.	Average	Std. Dev.	Pocket	Upstream
EB	Shared	1,050	175	48	300	91	275	92	0%	0%
NB	Left Turn	75	50	12	75	20	75	17	7%	0%
	Through/Right	575	175	54	325	86	350	77	15%	0%
SB	Left Turn	1,125	50	12	100	31	100	35	0%	0%
	Through	1,475	150	34	225	60	225	54	20%	0%
	Through/Right	1,475	125	41	225	79	225	74	0%	0%
WB	Left/Through	1,050	50	7	100	11	100	15	0%	0%
	Right Turn	175	25	3	25	14	25	18	0%	0%

SimTraffic Post-Processor
 Average Results from 10 Runs
 Queue Length
 Intersection 8

Marysville Bl/Arcade Bl

Vision Zero Top 5 Corridors - Marysville Bl
 Marysville Blvd Road Diet
 PM Peak Hour
 Signal

Direction	Lane Group	Storage (ft)	Average Queue (ft)		95th Queue (ft)		Maximum Queue (ft)		Block Time	
			Average	Std. Dev.	Average	Std. Dev.	Average	Std. Dev.	Pocket	Upstream
EB	Left Turn	150	50	17	100	48	100	58	0%	0%
	Through/Right	875	125	19	200	34	200	46	6%	0%
NB	Left Turn	125	25	3	50	7	50	37	0%	0%
	Through/Right	825	425	55	575	73	600	73	31%	0%
SB	Left Turn	750	400	52	525	72	525	66	0%	0%
	Through/Right	1,200	100	19	150	39	175	42	0%	0%
WB	Left Turn	125	75	17	125	25	150	24	4%	0%
	Through	925	400	114	600	170	600	153	35%	0%
	Right Turn	125	175	6	175	17	175	0	28%	0%



Major Street Marysville Blvd
 Minor Street Harris Ave

Project Vision Zero Top 5 Corridors
 Scenario Existing Conditions
 Peak Hour AM Peak Hour

Turn Movement Volumes

	NB	SB	EB	WB
Left	29	35	24	4
Through	697	948	11	3
Right	3	25	43	23
Total	729	1,008	78	30

Major Street Direction

x	North/South
	East/West

Intersection Geometry

Number of Approach Lanes for Minor Street	1
Total Approaches	4

Worst Case Delay for Minor Street

Stopped Delay (seconds per vehicle)	16.5
Approach with Worst Case Delay	EB
Total Vehicles on Approach	78

Warrant 3A, Peak Hour			
	Peak Hour Delay on Minor Approach (vehicle-hours)	Peak Hour Volume on Minor Approach (vph)	Peak Hour Entering Volume Serviced (vph)
Existing Conditions	0.4	78	1,845
Limiting Value	4	100	800
Condition Satisfied?	Not Met	Not Met	Met
Warrant Met	<u>NO</u>		



Major Street **Marysville Blvd**
 Minor Street **Harris Ave**

Project **Vision Zero Top 5 Corridors**
 Scenario **Existing Conditions**
 Peak Hour **AM Peak Hour**

Turn Movement Volumes

	NB	SB	EB	WB
Left	29	35	24	4
Through	697	948	11	3
Right	3	25	43	23
Total	729	1,008	78	30

Major Street Direction

x North/South
 East/West

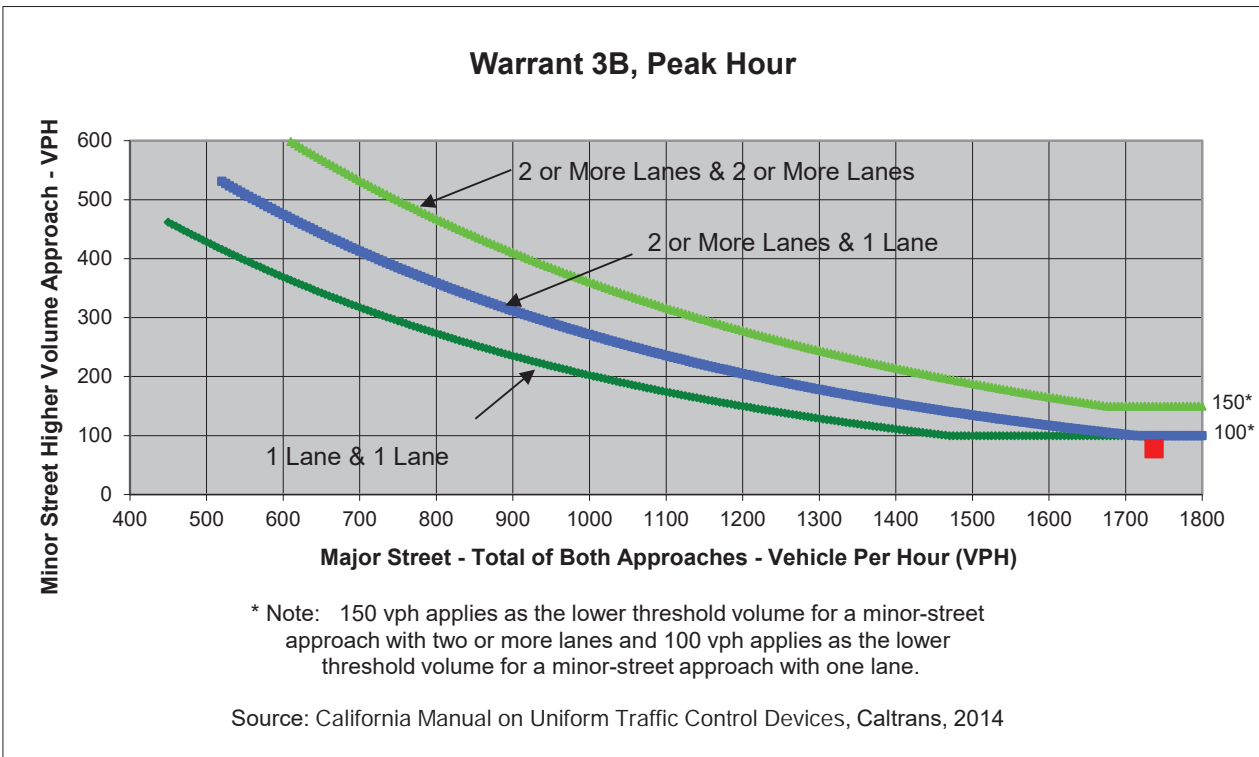

	Major Street	Minor Street	Warrant Met
	Marysville Blvd	Harris Ave	
Number of Approach Lanes	2	1	<u>NO</u>
Traffic Volume (VPH) *	1,737	78	

* Note: Traffic Volume for Major Street is Total Volume of Both Approches.
 Traffic Volume for Minor Street is the Volume of High Volume Approach.



Major Street Marysville Blvd
 Minor Street Harris Ave

Project Vision Zero Top 5 Corridors
 Scenario Existing Conditions
 Peak Hour PM Peak Hour

Turn Movement Volumes

	NB	SB	EB	WB
Left	61	51	31	3
Through	1,024	796	13	8
Right	16	34	31	48
Total	1,101	881	75	59

Major Street Direction

x	North/South
	East/West

Intersection Geometry

Number of Approach Lanes for Minor Street	1
Total Approaches	4

Worst Case Delay for Minor Street

Stopped Delay (seconds per vehicle)	20.3
Approach with Worst Case Delay	EB
Total Vehicles on Approach	75

Warrant 3A, Peak Hour			
	Peak Hour Delay on Minor Approach (vehicle-hours)	Peak Hour Volume on Minor Approach (vph)	Peak Hour Entering Volume Serviced (vph)
Existing Conditions	0.4	75	2,116
Limiting Value	4	100	800
Condition Satisfied?	Not Met	Not Met	Met
Warrant Met	<u>NO</u>		



Major Street **Marysville Blvd**
 Minor Street **Harris Ave**

Project **Vision Zero Top 5 Corridors**
 Scenario **Existing Conditions**
 Peak Hour **PM Peak Hour**

Turn Movement Volumes

	NB	SB	EB	WB
Left	61	51	31	3
Through	1,024	796	13	8
Right	16	34	31	48
Total	1,101	881	75	59

Major Street Direction

x North/South
 East/West

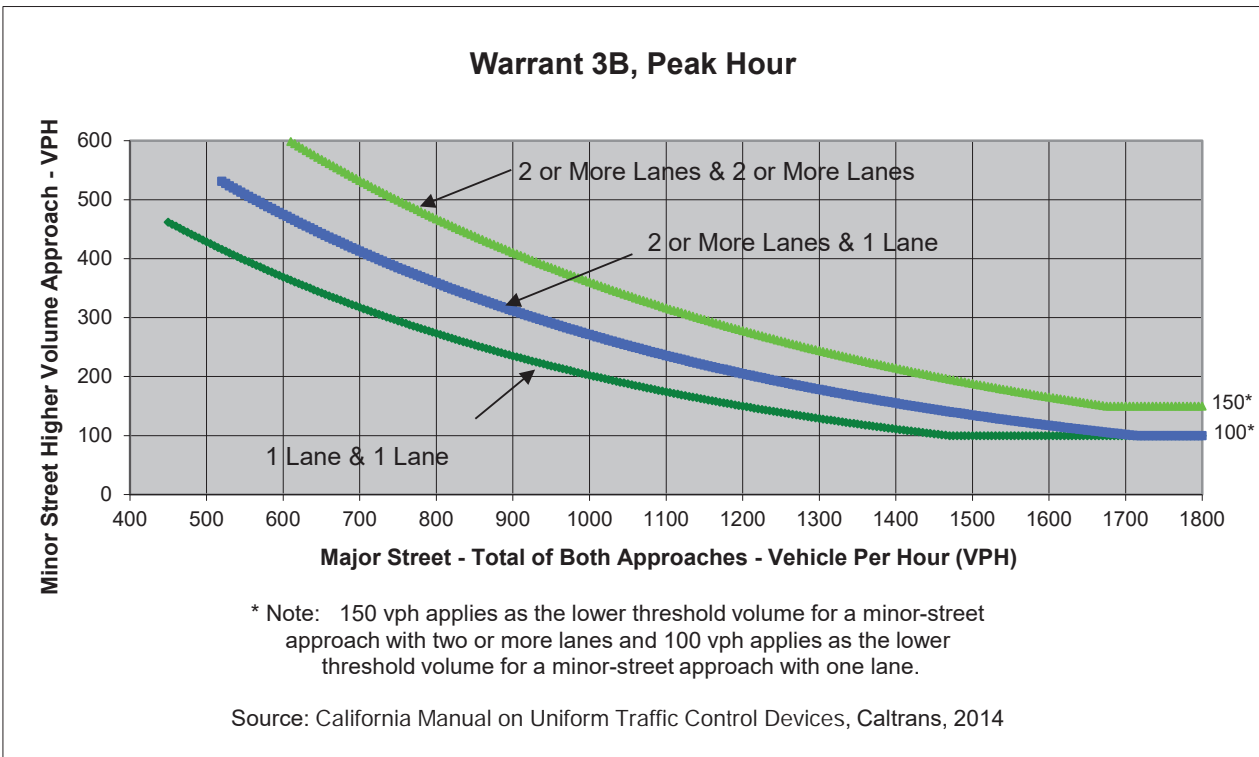

	Major Street	Minor Street	Warrant Met
	Marysville Blvd	Harris Ave	
Number of Approach Lanes	2	1	<u>NO</u>
Traffic Volume (VPH) *	1,982	75	

* Note: Traffic Volume for Major Street is Total Volume of Both Approches.
 Traffic Volume for Minor Street is the Volume of High Volume Approach.



Major Street Marysville Blvd
 Minor Street Roanoke Ave

Project Vision Zero Top 5 Corridors
 Scenario Existing Conditions
 Peak Hour AM Peak Hour

Turn Movement Volumes

	NB	SB	EB	WB
Left	13	21	1	5
Through	709	1,031	2	1
Right	11	10	17	20
Total	733	1,062	20	26

Major Street Direction

x	North/South
	East/West

Intersection Geometry

Number of Approach Lanes for Minor Street	1
Total Approaches	4

Worst Case Delay for Minor Street

Stopped Delay (seconds per vehicle)	12.2
Approach with Worst Case Delay	EB
Total Vehicles on Approach	20

Warrant 3A, Peak Hour			
	Peak Hour Delay on Minor Approach (vehicle-hours)	Peak Hour Volume on Minor Approach (vph)	Peak Hour Entering Volume Serviced (vph)
Existing Conditions	0.1	26	1,841
Limiting Value	4	100	800
Condition Satisfied?	Not Met	Not Met	Met
Warrant Met	<u>NO</u>		



Major Street **Marysville Blvd**
 Minor Street **Roanoke Ave**

Project **Vision Zero Top 5 Corridors**
 Scenario **Existing Conditions**
 Peak Hour **AM Peak Hour**

Turn Movement Volumes

	NB	SB	EB	WB
Left	13	21	1	5
Through	709	1,031	2	1
Right	11	10	17	20
Total	733	1,062	20	26

Major Street Direction

x North/South
 East/West

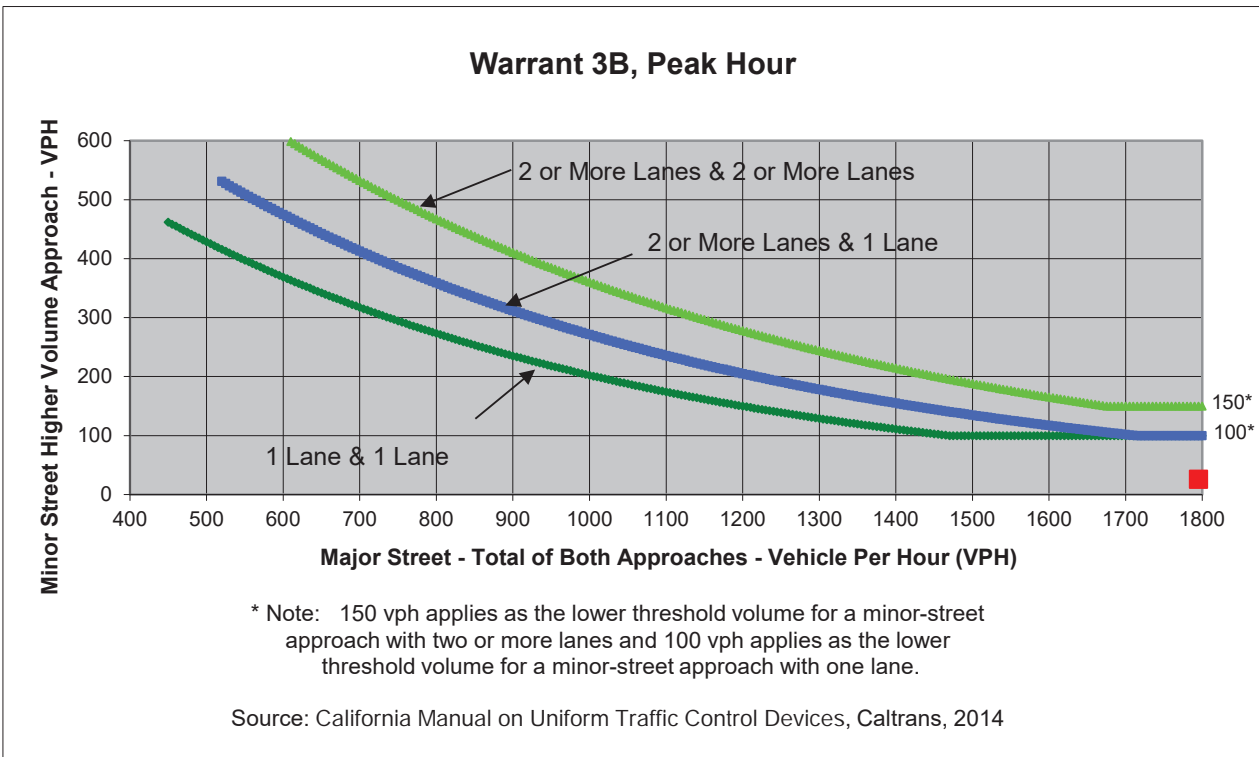

	Major Street	Minor Street	Warrant Met
	Marysville Blvd	Roanoke Ave	
Number of Approach Lanes	2	1	<u>NO</u>
Traffic Volume (VPH) *	1,795	26	

* Note: Traffic Volume for Major Street is Total Volume of Both Approches.
 Traffic Volume for Minor Street is the Volume of High Volume Approach.



Major Street Marysville Blvd
 Minor Street Roanoke Ave

Project Vision Zero Top 5 Corridors
 Scenario Existing Conditions
 Peak Hour PM Peak Hour

Turn Movement Volumes

	NB	SB	EB	WB
Left	21	22	2	14
Through	1,157	738	1	6
Right	30	25	25	27
Total	1,208	785	28	47

Major Street Direction

x	North/South
	East/West

Intersection Geometry

Number of Approach Lanes for Minor Street	1
Total Approaches	4

Worst Case Delay for Minor Street

Stopped Delay (seconds per vehicle)	67.6
Approach with Worst Case Delay	WB
Total Vehicles on Approach	47

Warrant 3A, Peak Hour			
	Peak Hour Delay on Minor Approach (vehicle-hours)	Peak Hour Volume on Minor Approach (vph)	Peak Hour Entering Volume Serviced (vph)
Existing Conditions	0.9	47	2,068
Limiting Value	4	100	800
Condition Satisfied?	Not Met	Not Met	Met
Warrant Met	<u>NO</u>		



Major Street **Marysville Blvd**
 Minor Street **Roanoke Ave**

Project **Vision Zero Top 5 Corridors**
 Scenario **Existing Conditions**
 Peak Hour **PM Peak Hour**

Turn Movement Volumes

	NB	SB	EB	WB
Left	21	22	2	14
Through	1,157	738	1	6
Right	30	25	25	27
Total	1,208	785	28	47

Major Street Direction

x North/South
 East/West

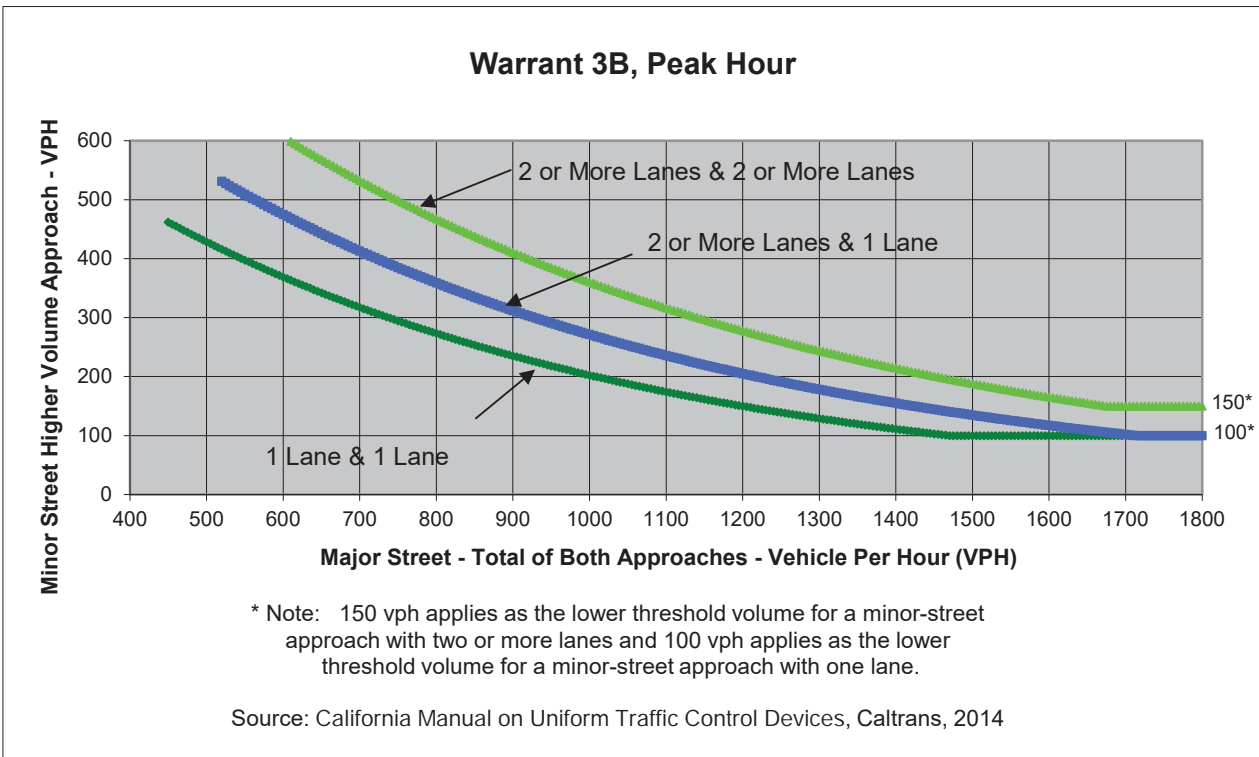

	Major Street	Minor Street	Warrant Met
	Marysville Blvd	Roanoke Ave	
Number of Approach Lanes	2	1	<u>NO</u>
Traffic Volume (VPH) *	1,993	47	

* Note: Traffic Volume for Major Street is Total Volume of Both Approches.
 Traffic Volume for Minor Street is the Volume of High Volume Approach.

Broadway/Stockton Boulevard

Vision Zero Top 5 Corridor Recommendations Results Summary – Broadway / Stockton Boulevard

Vision Zero Top 5 Corridor Recommendations Implemented

- Road diet on Broadway and Stockton Boulevard
- Traffic signals coordinated along Broadway and Stockton Boulevard
- New traffic signals at Broadway/San Diego Way and Stockton Boulevard/6th Avenue
 - Consolidate the Food Source and Walgreens driveways on Broadway to a new driveway aligned with San Diego Way that operates with a signal
- NBR overlap phase at this intersection and shorter cycle length at Broadway/Stockton Boulevard intersection
- Extended clearance time at all intersections

Additional Changes

- Lower Broadway Project and Envision Broadway assumed to be implemented. Stockton Boulevard Master Plan not implemented

Speed & Travel Time Results

Travel Times (min)	Dir	Existing Conditions		VZ Recommendations		% Change	
		AM Peak Hour	PM Peak Hour	AM Peak Hour	PM Peak Hour	AM Peak Hour	PM Peak Hour
Broadway - Martin Luther King Jr. Blvd to Stockton Blvd	EB	4.3	3.1	4.7	3.0	8%	-4%
	WB	2.9	2.8	3.2	3.8	9%	34%
	NB	4.6	2.6	5.4	2.7	19%	5%
	SB	2.4	3.1	2.4	4.3	1%	36%
Speed (mph)	Dir	Existing Conditions		VZ Recommendations		% Change	
		AM Peak Hour	PM Peak Hour	AM Peak Hour	PM Peak Hour	AM Peak Hour	PM Peak Hour
Broadway - Martin Luther King Jr. Blvd to Stockton Blvd	EB	14	20	12	19	-14%	-5%
	WB	20	21	20	16	0%	-24%
	NB	11	20	9	18	-18%	-10%
	SB	19	15	19	11	0%	-27%
Stockton Blvd - 14th Ave to Broadway	Dir	Existing Conditions		VZ Recommendations		% Change	
		AM Peak Hour	PM Peak Hour	AM Peak Hour	PM Peak Hour	AM Peak Hour	PM Peak Hour
	EB	14	20	12	19	-14%	-5%
	WB	20	21	20	16	0%	-24%
NB	11	20	9	18	-18%	-10%	
SB	19	15	19	11	0%	-27%	

Vision Zero Top 5 Corridor Recommendations Results Summary – Broadway / Stockton Boulevard

Delay & LOS Results

Intersection	Existing Conditions			VZ Recommendations		
	Control ¹	AM Peak Hour	PM Peak Hour	Control	AM Peak Hour	PM Peak Hour
Martin Luther King Jr. Blvd / Broadway	Signal	B / 14	B / 15	Signal	B / 18	C / 25
39 th St / Broadway	SSSC	A (C) / 2 (20)	A (A) / 3 (8)	SSSC	A (A) / 1 (10)	A / 7
Santa Cruz Wy / Broadway	SSSC	A (C) / 3 (18)	A (A) / 1 (7)	SSSC	A (C) / 4 (16)	A (A) / 1 (8)
42 nd St / Broadway	Signal	A / 5	A / 4	Signal	C / 20	A / 5
43 rd St / Broadway	SSSC	A (B) / 1 (15)	A (A) / 2 (9)	SSSC	C (F) / 21 (131)	A (A) / 2 (10)
San Diego Wy / Broadway	SSSC	<i>Not Analyzed</i>		Signal	D / 48	A / 7
Stockton Blvd / Broadway	Signal	D / 41	C / 34	Signal	D / 37	F / 83
Stockton Blvd / 6 th Av	SSSC	<i>Not Analyzed</i>		Signal	D / 54	A / 7
Stockton Blvd / 7 th Av	SSSC	A (E) / 7 (40)	A (B) / 1 (14)	SSSC	E (F) / 47 (166)	A (B) / 2 (15)
Stockton Blvd / 9 th Av	SSSC	A (D) / 2 (26)	A (C) / 1 (22)	SSSC	C (F) / 22 (61)	A (B) / 1 (14)
Stockton Blvd / 11 th Av	SSSC	A (C) / 1 (23)	A (D) / 2 (25)	SSSC	A (C) / 3 (15)	A (A) / 2 (8)
Stockton Blvd / 14 th Av	Signal	E / 63	E / 60	Signal	E / 72	E / 59

Arterial Level of Service: EB Broadway

Cross Street	Node	Delay (s/veh)	Travel time (s)	Dist (mi)	Arterial Speed
Martin Luther King J	19	10.8	51.4	0.4	25
HAWK	504	1.6	9.5	0.1	23
39th St	20	0.1	1.0	0.0	45
La Solidar Wy	111	1.9	11.4	0.1	26
HAWK	503	6.5	16.2	0.1	17
Santa Cruz Wy	21	0.6	1.8	0.0	24
San Jose Wy	112	2.7	7.8	0.0	20
42nd St	22	11.8	21.9	0.1	14
43rd St	23	7.4	14.1	0.1	15
HAWK	505	1.0	3.2	0.0	16
San Diego Wy	113	14.6	23.4	0.1	12
Stockton Bl	24	53.0	60.1	0.1	4
	128	29.4	39.3	0.1	7
Total		141.3	260.9	1.0	14

Arterial Level of Service: WB Broadway

Cross Street	Node	Delay (s/veh)	Travel time (s)	Dist (mi)	Arterial Speed
	128	1.2	36.9	0.3	30
Stockton Bl	24	35.6	44.3	0.1	7
San Diego Wy	113	2.9	11.2	0.1	21
HAWK	505	0.7	9.9	0.1	28
43rd St	23	0.1	1.4	0.0	38
42nd St	22	4.9	12.2	0.1	17
San Jose Wy	112	1.3	11.5	0.1	27
	21	2.9	8.0	0.0	19
HAWK	503	1.3	3.0	0.0	14
La Solidar Wy	111	0.6	9.4	0.1	30
39th St	20	0.6	10.7	0.1	27
HAWK	504	0.1	1.7	0.0	25
Martin Luther King J	19	8.5	15.6	0.1	14
Total		60.7	175.9	1.0	20

Arterial Level of Service: NB Stockton Bl

Cross Street	Node	Delay (s/veh)	Travel time (s)	Dist (mi)	Arterial Speed
14th Av	28	84.9	110.9	0.3	9
13th Av	116	6.4	11.4	0.0	15
	133	10.9	20.1	0.1	16
11th Av	110	4.4	6.8	0.0	14
11th Av	27	5.5	8.9	0.0	11
	134	5.2	8.0	0.0	12
10th Av	127	7.4	10.3	0.0	12
PED CROSSING	506	6.2	9.6	0.0	12
9th Av	129	1.8	3.8	0.0	21
9th Av	26	2.1	5.2	0.0	15
	131	2.0	4.2	0.0	18
8th Av	126	3.4	6.4	0.0	20
	132	3.9	6.7	0.0	14
7th Av	130	5.0	7.1	0.0	12
7th Av	25	4.5	7.5	0.0	10
6th Av	114	6.5	9.5	0.0	13
Broadway	24	31.2	36.9	0.1	6
Total		191.4	273.1	0.8	11

Arterial Level of Service: SB Stockton Bl

Cross Street	Node	Delay (s/veh)	Travel time (s)	Dist (mi)	Arterial Speed
Broadway	24	30.9	50.7	0.2	15
6th Av	114	2.0	8.5	0.1	26
7th Av	25	0.1	3.5	0.0	35
7th Av	130	0.1	3.0	0.0	25
	132	0.1	2.0	0.0	42
8th Av	126	0.2	2.7	0.0	33
	131	0.4	4.1	0.0	31
9th Av	26	0.3	2.1	0.0	35
9th Av	129	0.3	3.3	0.0	24
PED CROSSING	506	0.1	2.5	0.0	33
10th Av	127	0.1	2.9	0.0	40
	134	0.1	3.6	0.0	33
11th Av	27	0.1	2.6	0.0	37
11th Av	110	0.1	3.5	0.0	26
	133	0.1	2.8	0.0	33
13th Av	116	1.6	10.2	0.1	32
14th Av	28	29.7	34.6	0.0	5
Total		66.5	142.8	0.8	19

Arterial Level of Service
Existing Conditions

PM Peak Hour
Vision Zero - Top 5 Corridors

Arterial Level of Service: EB Broadway

Cross Street	Node	Delay (s/veh)	Travel time (s)	Dist (mi)	Arterial Speed
Martin Luther King J	19	12.5	53.2	0.4	24
HAWK	504	3.2	11.0	0.1	20
39th St	20	0.2	1.1	0.0	40
La Solidar Wy	111	1.6	11.0	0.1	27
HAWK	503	0.7	10.4	0.1	27
Santa Cruz Wy	21	0.1	1.3	0.0	32
San Jose Wy	112	0.4	5.5	0.0	28
42nd St	22	4.0	14.1	0.1	22
43rd St	23	1.1	7.8	0.1	27
HAWK	505	0.2	2.4	0.0	22
San Diego Wy	113	0.8	9.6	0.1	29
Stockton Bl	24	35.2	42.3	0.1	6
	128	4.6	14.8	0.1	20
Total		64.5	184.4	1.0	20

Arterial Level of Service: WB Broadway

Cross Street	Node	Delay (s/veh)	Travel time (s)	Dist (mi)	Arterial Speed
	128	2.7	38.8	0.3	29
Stockton Bl	24	32.1	40.9	0.1	7
San Diego Wy	113	2.3	10.5	0.1	22
HAWK	505	1.6	11.0	0.1	25
43rd St	23	0.2	1.5	0.0	36
42nd St	22	4.1	11.3	0.1	19
San Jose Wy	112	1.2	11.4	0.1	27
	21	0.5	5.6	0.0	28
HAWK	503	0.1	1.8	0.0	23
La Solidar Wy	111	0.6	9.3	0.1	30
39th St	20	1.7	11.8	0.1	25
HAWK	504	0.6	2.2	0.0	20
Martin Luther King J	19	7.6	14.6	0.1	15
Total		55.2	170.7	1.0	21

Arterial Level of Service: NB Stockton Bl

Cross Street	Node	Delay (s/veh)	Travel time (s)	Dist (mi)	Arterial Speed
14th Av	28	34.7	61.7	0.3	17
13th Av	116	2.5	7.5	0.0	23
	133	0.6	10.1	0.1	32
11th Av	110	0.2	2.6	0.0	36
11th Av	27	0.2	3.7	0.0	26
	134	0.2	3.0	0.0	32
	127	0.2	3.1	0.0	39
PED CROSSING	506	0.5	3.9	0.0	30
9th Av	129	0.4	2.4	0.0	33
9th Av	26	0.2	3.2	0.0	24
	131	0.1	2.2	0.0	33
8th Av	126	0.2	3.2	0.0	39
	132	0.2	2.9	0.0	32
7th Av	130	0.2	2.3	0.0	37
7th Av	25	0.3	3.3	0.0	23
6th Av	114	0.8	3.8	0.0	33
Broadway	24	28.6	34.3	0.1	6
Total		70.1	153.3	0.8	20

Arterial Level of Service: SB Stockton Bl

Cross Street	Node	Delay (s/veh)	Travel time (s)	Dist (mi)	Arterial Speed
Broadway	24	35.3	55.3	0.2	14
6th Av	114	3.3	9.9	0.1	22
7th Av	25	0.4	3.7	0.0	33
7th Av	130	0.2	3.2	0.0	24
	132	0.2	2.1	0.0	41
8th Av	126	0.3	2.8	0.0	33
	131	0.6	4.3	0.0	30
9th Av	26	0.4	2.2	0.0	34
9th Av	129	0.5	3.5	0.0	22
PED CROSSING	506	0.2	2.6	0.0	31
	127	0.3	3.1	0.0	38
	134	0.5	4.0	0.0	30
11th Av	27	0.5	3.0	0.0	32
11th Av	110	1.2	4.7	0.0	20
	133	2.4	5.1	0.0	18
13th Av	116	35.2	43.6	0.1	7
14th Av	28	31.0	35.8	0.0	5
Total		112.5	188.9	0.8	15

Arterial Level of Service: EB Broadway

Cross Street	Node	Delay (s/veh)	Travel time (s)	Dist (mi)	Arterial Speed
	151	1.7	35.5	0.3	30
Martin Luther King J	19	13.1	20.4	0.1	11
HAWK	504	1.7	9.5	0.1	23
39th St	20	0.0	0.9	0.0	47
La Solidar Wy	111	0.5	10.1	0.1	29
HAWK	503	3.2	12.8	0.1	22
Santa Cruz Wy	21	0.9	2.1	0.0	20
San Jose Wy	112	3.5	8.6	0.0	18
42nd St	22	21.9	32.2	0.1	10
43rd St	23	17.2	24.0	0.1	9
	505	8.0	10.3	0.0	5
San Diego Wy	113	51.4	59.9	0.1	5
Stockton Bl	24	47.8	54.6	0.1	4
Total		170.9	281.0	0.9	12

Arterial Level of Service: WB Broadway

Cross Street	Node	Delay (s/veh)	Travel time (s)	Dist (mi)	Arterial Speed
Stockton Bl	24	38.1	80.4	0.4	18
	113	12.6	20.9	0.1	11
HAWK	505	1.9	11.5	0.1	24
43rd St	23	0.2	1.3	0.0	39
42nd St	22	4.7	12.0	0.1	17
San Jose Wy	112	1.8	11.9	0.1	26
	21	1.9	6.9	0.0	22
HAWK	503	0.6	2.2	0.0	19
La Solidar Wy	111	0.7	9.6	0.1	29
39th St	20	1.0	11.0	0.1	27
HAWK	504	0.3	1.9	0.0	23
Martin Luther King J	19	6.7	13.7	0.1	16
	151	1.2	8.8	0.1	25
Total		71.8	192.2	1.0	20

Arterial Level of Service: NB Stockton Bl

Cross Street	Node	Delay (s/veh)	Travel time (s)	Dist (mi)	Arterial Speed
14th Av	28	100.4	126.0	0.3	8
13th Av	116	15.2	20.2	0.0	9
	133	3.8	13.1	0.1	25
11th Av	110	1.2	3.6	0.0	26
11th Av	27	2.0	5.3	0.0	18
	134	2.6	5.3	0.0	18
10th Av	127	4.1	7.0	0.0	17
PED CROSSING	506	4.5	8.0	0.0	15
9th Av	129	2.9	5.0	0.0	16
9th Av	26	5.2	8.0	0.0	10
	131	5.8	7.9	0.0	9
8th Av	126	12.0	15.0	0.0	8
	132	15.6	18.7	0.0	5
7th Av	130	10.4	12.2	0.0	7
7th Av	25	8.8	11.7	0.0	7
6th Av	114	10.9	14.0	0.0	9
Broadway	24	36.6	42.6	0.1	5
Total		242.2	323.7	0.8	9

Arterial Level of Service: SB Stockton Bl

Cross Street	Node	Delay (s/veh)	Travel time (s)	Dist (mi)	Arterial Speed
Broadway	24	25.6	47.3	0.2	16
6th Av	114	4.6	10.9	0.1	20
7th Av	25	1.0	4.4	0.0	28
7th Av	130	0.3	3.1	0.0	25
	132	0.2	2.2	0.0	39
8th Av	126	0.3	2.9	0.0	32
	131	0.8	4.5	0.0	28
9th Av	26	0.7	2.5	0.0	29
9th Av	129	0.6	3.5	0.0	22
PED CROSSING	506	0.2	2.6	0.0	31
10th Av	127	0.3	3.2	0.0	37
	134	0.4	3.9	0.0	30
11th Av	27	0.3	2.8	0.0	34
11th Av	110	0.3	3.6	0.0	26
	133	0.2	2.9	0.0	32
13th Av	116	2.1	11.0	0.1	30
14th Av	28	28.0	32.8	0.0	5
Total		65.8	144.2	0.8	19

Arterial Level of Service: EB Broadway

Cross Street	Node	Delay (s/veh)	Travel time (s)	Dist (mi)	Arterial Speed
	151	2.1	36.0	0.3	30
Martin Luther King J	19	15.9	23.4	0.1	10
HAWK	504	4.0	11.8	0.1	18
39th St	20	0.1	1.0	0.0	42
La Solidar Wy	111	0.6	10.2	0.1	29
HAWK	503	0.6	10.3	0.1	27
Santa Cruz Wy	21	0.1	1.3	0.0	32
San Jose Wy	112	0.5	5.6	0.0	27
42nd St	22	2.8	13.1	0.1	24
43rd St	23	1.0	7.6	0.1	28
	505	0.2	2.5	0.0	21
San Diego Wy	113	3.8	12.8	0.1	22
Stockton Bl	24	34.5	41.8	0.1	6
Total		66.2	177.5	0.9	19

Arterial Level of Service: WB Broadway

Cross Street	Node	Delay (s/veh)	Travel time (s)	Dist (mi)	Arterial Speed
Stockton Bl	24	77.6	120.1	0.4	12
	113	7.2	15.4	0.1	15
HAWK	505	2.2	11.6	0.1	24
43rd St	23	0.3	1.4	0.0	38
42nd St	22	4.1	11.5	0.1	18
San Jose Wy	112	1.6	11.9	0.1	26
	21	0.6	5.8	0.0	27
HAWK	503	0.2	1.8	0.0	23
La Solidar Wy	111	1.2	10.0	0.1	28
39th St	20	6.8	16.8	0.1	18
HAWK	504	1.4	3.0	0.0	14
Martin Luther King J	19	4.8	11.7	0.1	19
	151	0.5	8.1	0.1	28
Total		108.4	229.0	1.0	16

Arterial Level of Service: NB Stockton Bl

Cross Street	Node	Delay (s/veh)	Travel time (s)	Dist (mi)	Arterial Speed
14th Av	28	29.6	57.9	0.3	18
13th Av	116	1.9	6.9	0.0	25
	133	0.4	9.7	0.1	34
11th Av	110	0.2	2.6	0.0	36
11th Av	27	0.3	3.6	0.0	26
	134	0.2	3.0	0.0	32
	127	0.3	3.2	0.0	37
PED CROSSING	506	0.4	3.9	0.0	31
9th Av	129	0.3	2.4	0.0	34
9th Av	26	0.3	3.2	0.0	24
	131	0.1	2.3	0.0	32
8th Av	126	0.2	3.3	0.0	38
	132	0.4	3.5	0.0	26
7th Av	130	0.6	2.3	0.0	37
7th Av	25	1.5	4.3	0.0	18
6th Av	114	3.9	6.9	0.0	18
Broadway	24	36.5	42.3	0.1	5
	246	3.5	25.2	0.2	30
Total		80.8	186.4	1.0	20

Arterial Level of Service: SB Stockton Bl

Cross Street	Node	Delay (s/veh)	Travel time (s)	Dist (mi)	Arterial Speed
	246	32.4	74.1	0.4	21
Broadway	24	99.0	117.2	0.2	7
6th Av	114	6.1	12.5	0.1	18
7th Av	25	1.2	4.7	0.0	27
7th Av	130	0.5	3.3	0.0	23
	132	0.2	2.2	0.0	38
8th Av	126	0.3	2.8	0.0	32
	131	0.6	4.3	0.0	29
9th Av	26	0.4	2.2	0.0	33
9th Av	129	0.5	3.4	0.0	23
PED CROSSING	506	0.3	2.7	0.0	31
	127	0.4	3.2	0.0	36
	134	0.5	4.1	0.0	29
11th Av	27	0.6	3.2	0.0	31
11th Av	110	1.3	4.6	0.0	20
	133	2.1	4.8	0.0	19
13th Av	116	25.7	34.3	0.1	10
14th Av	28	41.4	46.5	0.0	4
Total		213.6	330.1	1.2	13

SimTraffic Post-Processor
Average Results from 10 Runs
Volume and Delay by Movement

Vision Zero Top 5 Corridors - Broadway & Stockton BI
Broadway/Stockton Blvd Road Diet
AM Peak Hour

Intersection 19 Martin Luther King Jr Bl/Broadway Signal

Direction	Movement	Demand Volume (vph)	Served Volume (vph)		Total Delay (sec/veh)		
			Average	Percent	Average	Std. Dev.	LOS
NB	Left Turn	283	276	97.6%	38.1	4.2	D
	Through						
	Right Turn	261	259	99.2%	15.1	3.7	B
	Subtotal	544	535	98.4%	27.0	3.5	C
SB	Left Turn						
	Through						
	Right Turn						
	Subtotal						
EB	Left Turn						
	Through	338	351	103.9%	14.8	1.7	B
	Right Turn	121	118	97.2%	9.5	2.6	A
	Subtotal	459	469	102.1%	13.5	1.7	B
WB	Left Turn	86	80	93.5%	40.9	9.9	D
	Through	387	358	92.5%	6.7	0.9	A
	Right Turn						
	Subtotal	473	438	92.7%	13.0	2.3	B
Total		1,476	1,442	97.7%	18.4	1.7	B

Intersection 20 39th St/Broadway Side-street Stop

Direction	Movement	Demand Volume (vph)	Served Volume (vph)		Total Delay (sec/veh)		
			Average	Percent	Average	Std. Dev.	LOS
NB	Left Turn	2	1	34.8%	9.5	20.9	A
	Through	1	0	0.0%	0.0	0.1	A
	Right Turn	6	7	116.0%	3.9	2.9	A
	Subtotal	9	8	85.1%	10.9	17.7	B
SB	Left Turn	1	1	69.6%	3.8	8.9	A
	Through						
	Right Turn	14	15	104.4%	4.3	1.8	A
	Subtotal	15	15	102.1%	4.8	2.5	A
EB	Left Turn	25	21	84.9%	3.9	3.2	A
	Through	570	565	99.1%	1.3	0.1	A
	Right Turn	3	1	46.4%	1.3	0.1	A
	Subtotal	598	588	98.3%	1.4	0.1	A
WB	Left Turn	4	3	78.3%	2.1	2.0	A
	Through	441	408	92.4%	1.2	0.2	A
	Right Turn	3	1	46.4%	0.4	0.3	A
	Subtotal	448	412	92.0%	1.2	0.2	A
Total		1,070	1,023	95.6%	1.4	0.1	A

SimTraffic Post-Processor
Average Results from 10 Runs
Volume and Delay by Movement

Vision Zero Top 5 Corridors - Broadway & Stockton Bl
Broadway/Stockton Blvd Road Diet
AM Peak Hour

Intersection 21 Santa Cruz Wy/Broadway Side-street Stop

Direction	Movement	Demand Volume (vph)	Served Volume (vph)		Total Delay (sec/veh)		
			Average	Percent	Average	Std. Dev.	LOS
NB	Left Turn	5	3	62.6%	9.0	10.4	A
	Through						
	Right Turn	5	8	153.1%	4.1	3.8	A
	Subtotal	10	11	107.9%	6.0	4.1	A
SB	Left Turn	5	5	97.4%	15.5	13.6	C
	Through						
	Right Turn	2	2	104.4%	1.6	1.8	A
	Subtotal	7	7	99.4%	12.6	12.9	B
EB	Left Turn	2	2	121.8%	4.5	3.0	A
	Through	568	547	96.3%	4.6	3.9	A
	Right Turn	7	7	104.4%	3.7	3.0	A
	Subtotal	577	556	96.4%	4.5	3.9	A
WB	Left Turn	2	1	52.2%	1.0	1.0	A
	Through	408	377	92.4%	2.5	1.3	A
	Right Turn	4	5	113.1%	2.8	5.4	A
	Subtotal	414	382	92.4%	2.5	1.2	A
Total		1,008	957	94.9%	3.9	2.6	A

Intersection 22 42nd St/Broadway Signal

Direction	Movement	Demand Volume (vph)	Served Volume (vph)		Total Delay (sec/veh)		
			Average	Percent	Average	Std. Dev.	LOS
NB	Left Turn	43	41	94.7%	19.0	4.3	B
	Through	20	21	106.1%	20.5	7.3	C
	Right Turn	37	35	94.1%	14.4	5.4	B
	Subtotal	100	97	96.7%	17.5	4.3	B
SB	Left Turn	21	24	116.0%	21.9	8.2	C
	Through	13	12	91.0%	24.2	12.7	C
	Right Turn	6	6	92.8%	5.7	7.4	A
	Subtotal	40	42	104.4%	20.3	6.2	C
EB	Left Turn	11	10	91.7%	25.4	29.9	C
	Through	541	493	91.2%	30.7	21.1	C
	Right Turn	18	23	125.7%	25.5	20.9	C
	Subtotal	570	526	92.3%	30.4	21.3	C
WB	Left Turn	6	6	98.6%	7.9	9.5	A
	Through	354	323	91.3%	4.6	1.6	A
	Right Turn	5	7	132.2%	1.5	2.4	A
	Subtotal	365	336	92.0%	4.7	1.6	A
Total		1,075	1,001	93.1%	20.4	12.0	C

SimTraffic Post-Processor
Average Results from 10 Runs
Volume and Delay by Movement

Vision Zero Top 5 Corridors - Broadway & Stockton Bl
Broadway/Stockton Blvd Road Diet
AM Peak Hour

Intersection 23 43rd St/Broadway Side-street Stop

Direction	Movement	Demand Volume (vph)	Served Volume (vph)		Total Delay (sec/veh)		
			Average	Percent	Average	Std. Dev.	LOS
NB	Left Turn	4	2	43.5%	48.9	71.9	E
	Through	42	25	59.7%	129.6	69.8	F
	Right Turn	43	24	56.7%	131.4	72.1	F
	Subtotal	89	51	57.5%	123.6	62.1	F
SB	Left Turn	2	1	52.2%	32.0	56.9	D
	Through	1	0	34.8%	14.1	44.7	B
	Right Turn	4	6	156.6%	10.2	8.9	B
	Subtotal	7	8	109.4%	19.4	22.9	C
EB	Left Turn	4	6	147.9%	17.9	12.7	C
	Through	594	530	89.2%	24.2	11.8	C
	Right Turn	1	0	34.8%	7.7	3.5	A
	Subtotal	599	536	89.5%	24.2	11.7	C
WB	Left Turn	7	5	69.6%	37.6	49.7	E
	Through	357	327	91.7%	2.0	0.5	A
	Right Turn	2	1	52.2%	1.8	0.3	A
	Subtotal	366	333	91.1%	2.8	1.6	A
Total		1,061	928	87.5%	21.0	9.3	C

Intersection 24 Stockton Bl/Broadway Signal

Direction	Movement	Demand Volume (vph)	Served Volume (vph)		Total Delay (sec/veh)		
			Average	Percent	Average	Std. Dev.	LOS
NB	Left Turn	70	53	76.1%	51.6	7.9	D
	Through	504	374	74.3%	36.4	2.5	D
	Right Turn	262	211	80.5%	18.2	3.3	B
	Subtotal	836	639	76.4%	31.8	2.4	C
SB	Left Turn	164	157	95.5%	53.2	10.2	D
	Through	227	226	99.3%	25.6	2.3	C
	Right Turn	27	23	85.1%	8.7	3.2	A
	Subtotal	418	405	96.9%	35.3	4.5	D
EB	Left Turn	141	112	79.5%	56.5	5.8	E
	Through	468	367	78.5%	49.3	4.9	D
	Right Turn	54	43	79.9%	11.8	2.8	B
	Subtotal	663	523	78.8%	47.8	3.0	D
WB	Left Turn	99	90	91.0%	43.1	5.0	D
	Through	242	231	95.6%	37.8	3.0	D
	Right Turn	190	198	104.4%	21.0	5.5	C
	Subtotal	531	520	97.9%	32.3	2.9	C
Total		2,448	2,086	85.2%	36.6	2.0	D

Intersection 25 **Stockton Bl/7th Av** **Side-street Stop**

Direction	Movement	Demand Volume (vph)	Served Volume (vph)		Total Delay (sec/veh)		
			Average	Percent	Average	Std. Dev.	LOS
NB	Left Turn	27	22	82.8%	71.6	24.7	F
	Through	834	635	76.2%	72.3	24.5	F
	Right Turn	5	3	69.6%	4.5	6.9	A
	Subtotal	866	661	76.3%	71.9	24.4	F
SB	Left Turn	4	3	69.6%	9.0	11.8	A
	Through	373	351	94.1%	1.3	0.3	A
	Right Turn	2	2	121.8%	0.1	0.2	A
	Subtotal	379	356	94.0%	1.5	0.4	A
EB	Left Turn	2	0	17.4%	85.1	217.3	F
	Through	0	0	0.0%	0.0	0.0	A
	Right Turn	5	6	125.3%	5.0	4.5	A
	Subtotal	7	7	94.5%	17.1	36.9	C
WB	Left Turn	6	4	69.6%	104.5	146.4	F
	Through	0	0	0.0%	40.7	67.2	E
	Right Turn	12	6	47.1%	166.1	147.0	F
	Subtotal	18	10	56.1%	131.3	150.4	F
Total		1,270	1,034	81.4%	47.2	15.5	E

Intersection 26 **Stockton Bl/9th Av** **Side-street Stop**

Direction	Movement	Demand Volume (vph)	Served Volume (vph)		Total Delay (sec/veh)		
			Average	Percent	Average	Std. Dev.	LOS
NB	Left Turn	97	82	84.1%	35.1	17.9	E
	Through	800	636	79.6%	33.7	20.0	D
	Right Turn	2	2	121.8%	14.2	9.4	B
	Subtotal	899	721	80.1%	33.8	19.8	D
SB	Left Turn	21	21	99.0%	22.2	10.5	C
	Through	403	374	92.9%	1.2	0.3	A
	Right Turn	33	32	98.1%	0.1	0.1	A
	Subtotal	457	428	93.6%	2.2	0.9	A
EB	Left Turn	5	7	146.2%	15.5	14.5	C
	Through	1	1	113.1%	26.8	10.5	D
	Right Turn	28	25	89.2%	5.8	2.0	A
	Subtotal	34	33	98.3%	8.3	3.4	A
WB	Left Turn	2	1	34.8%	9.6	23.9	A
	Through	4	3	82.7%	61.4	28.1	F
	Right Turn	29	19	64.2%	59.9	30.0	F
	Subtotal	35	23	64.6%	57.2	21.9	F
Total		1,425	1,204	84.5%	22.2	12.3	C

SimTraffic Post-Processor
Average Results from 10 Runs
Volume and Delay by Movement

Vision Zero Top 5 Corridors - Broadway & Stockton BI
Broadway/Stockton Blvd Road Diet
AM Peak Hour

Intersection 27 **Stockton BI/11th Av** **Side-street Stop**

Direction	Movement	Demand Volume (vph)	Served Volume (vph)		Total Delay (sec/veh)		
			Average	Percent	Average	Std. Dev.	LOS
NB	Left Turn	16	15	91.9%	4.9	2.6	A
	Through	817	671	82.2%	3.1	3.0	A
	Right Turn	2	0	17.4%	0.0	0.0	A
	Subtotal	835	686	82.2%	3.1	2.9	A
SB	Left Turn	5	3	62.6%	3.2	6.7	A
	Through	406	381	93.9%	0.6	0.1	A
	Right Turn	13	15	112.4%	0.1	0.2	A
	Subtotal	424	399	94.1%	0.6	0.3	A
EB	Left Turn	9	9	96.7%	5.2	2.6	A
	Through	0	0	0.0%	0.0	0.0	A
	Right Turn	8	7	82.7%	4.8	2.3	A
	Subtotal	17	15	90.1%	5.0	1.4	A
WB	Left Turn	2	2	87.0%	6.4	12.4	A
	Through	1	1	60.9%	0.0	0.0	A
	Right Turn	28	28	101.0%	15.2	6.2	C
	Subtotal	31	31	98.8%	15.0	5.9	C
Total		1,307	1,131	86.6%	2.6	1.8	A

Intersection 28 **Stockton BI/14th Av** **Signal**

Direction	Movement	Demand Volume (vph)	Served Volume (vph)		Total Delay (sec/veh)		
			Average	Percent	Average	Std. Dev.	LOS
NB	Left Turn	130	113	87.3%	86.2	16.7	F
	Through	881	739	83.9%	100.6	25.7	F
	Right Turn	60	56	92.8%	80.3	25.1	F
	Subtotal	1,071	908	84.8%	97.4	23.8	F
SB	Left Turn	61	54	87.9%	54.6	11.6	D
	Through	370	340	91.9%	30.0	4.9	C
	Right Turn	17	15	86.0%	24.4	12.8	C
	Subtotal	448	408	91.1%	33.0	4.8	C
EB	Left Turn	30	24	78.9%	68.1	25.3	E
	Through	175	164	93.7%	68.9	29.4	E
	Right Turn	64	64	99.5%	57.7	23.0	E
	Subtotal	269	251	93.4%	66.5	27.2	E
WB	Left Turn	55	55	100.0%	41.8	6.6	D
	Through	150	131	87.0%	50.2	18.3	D
	Right Turn	10	10	100.9%	46.9	31.7	D
	Subtotal	215	196	91.0%	47.1	13.6	D
Total		1,307	1,301	99.5%	72.0	13.0	E

SimTraffic Post-Processor
Average Results from 10 Runs
Volume and Delay by Movement

Vision Zero Top 5 Corridors - Broadway & Stockton Bl
Broadway/Stockton Blvd Road Diet
AM Peak Hour

Intersection 113

San Diego Wy/Broadway

Signal

Direction	Movement	Demand Volume (vph)	Served Volume (vph)		Total Delay (sec/veh)		
			Average	Percent	Average	Std. Dev.	LOS
NB	Left Turn	10	6	62.6%	22.8	11.8	C
	Through	2	2	121.8%	14.9	19.0	B
	Right Turn	10	7	69.6%	29.4	22.0	C
	Subtotal	22	16	71.2%	29.6	10.9	C
SB	Left Turn	49	50	101.6%	33.3	4.1	C
	Through	2	2	121.8%	18.3	21.3	B
	Right Turn	37	37	100.6%	16.6	4.9	B
	Subtotal	88	89	101.6%	26.1	3.3	C
EB	Left Turn	30	24	78.9%	73.1	32.9	E
	Through	604	476	78.8%	75.6	27.1	E
	Right Turn	5	6	111.4%	61.1	32.4	E
	Subtotal	639	505	79.0%	75.4	27.3	E
WB	Left Turn	5	4	76.6%	15.3	20.6	B
	Through	319	291	91.3%	11.4	1.2	B
	Right Turn	15	14	92.8%	7.1	4.8	A
	Subtotal	339	309	91.2%	11.4	1.3	B
Total		1,088	919	84.5%	48.1	15.0	D

SimTraffic Post-Processor
Average Results from 10 Runs
Volume and Delay by Movement

Vision Zero Top 5 Corridors - Broadway & Stockton BI
Broadway/Stockton Blvd Road Diet
AM Peak Hour

Intersection 114

6th Av/Stockton BI

Signal

Direction	Movement	Demand Volume (vph)	Served Volume (vph)		Total Delay (sec/veh)		
			Average	Percent	Average	Std. Dev.	LOS
NB	Left Turn	5	3	69.6%	75.8	26.0	E
	Through	811	611	75.3%	83.2	26.1	F
	Right Turn	32	22	69.6%	82.8	25.7	F
	Subtotal	848	636	75.1%	83.2	26.1	F
SB	Left Turn	15	14	90.5%	27.4	13.9	C
	Through	359	340	94.8%	5.0	1.0	A
	Right Turn	6	4	63.8%	2.0	3.3	A
	Subtotal	380	358	94.1%	5.9	1.2	A
EB	Left Turn	5	6	118.3%	22.6	16.2	C
	Through	2	2	87.0%	10.8	16.5	B
	Right Turn	5	4	76.6%	1.8	1.9	A
	Subtotal	12	11	95.7%	17.5	7.6	B
WB	Left Turn	15	13	85.8%	25.1	6.7	C
	Through	2	1	34.8%	1.1	2.7	A
	Right Turn	20	23	114.8%	23.0	9.4	C
	Subtotal	37	37	98.8%	22.9	7.1	C
Total		1,277	1,042	81.6%	53.5	15.6	D

SimTraffic Post-Processor
Average Results from 10 Runs
Volume and Delay by Movement

Vision Zero Top 5 Corridors - Broadway & Stockton Bl
Broadway/Stockton Blvd Road Diet
PM Peak Hour

Intersection 19 Martin Luther King Jr Bl/Broadway Signal

Direction	Movement	Demand Volume (vph)	Served Volume (vph)		Total Delay (sec/veh)		
			Average	Percent	Average	Std. Dev.	LOS
NB	Left Turn	156	165	105.6%	44.2	4.5	D
	Through						
	Right Turn	114	115	100.9%	7.4	0.9	A
	Subtotal	270	280	103.6%	29.0	4.1	C
SB	Left Turn						
	Through						
	Right Turn						
	Subtotal						
EB	Left Turn						
	Through	274	272	99.2%	16.0	2.8	B
	Right Turn	336	331	98.4%	11.0	1.8	B
	Subtotal	610	602	98.7%	13.2	1.9	B
WB	Left Turn	281	276	98.2%	60.1	5.6	E
	Through	366	316	86.4%	12.9	4.2	B
	Right Turn						
	Subtotal	647	592	91.5%	34.9	4.4	C
Total		1,527	1,474	96.5%	24.9	2.5	C

Intersection 20 39th St/Broadway Side-street Stop

Direction	Movement	Demand Volume (vph)	Served Volume (vph)		Total Delay (sec/veh)		
			Average	Percent	Average	Std. Dev.	LOS
NB	Left Turn	1	1	75.2%	0.6	1.8	A
	Through						
	Right Turn	3	3	100.3%	2.0	1.9	A
	Subtotal	4	4	94.0%	2.2	2.1	A
SB	Left Turn	1	1	75.2%	2.5	6.5	A
	Through						
	Right Turn	11	12	106.0%	21.0	31.4	C
	Subtotal	12	12	103.4%	19.8	26.5	C
EB	Left Turn	10	8	75.2%	12.3	10.1	B
	Through	372	367	98.8%	3.7	1.8	A
	Right Turn	6	7	119.1%	3.5	1.7	A
	Subtotal	388	382	98.5%	3.8	1.8	A
WB	Left Turn	18	15	83.6%	8.5	7.1	A
	Through	634	569	89.8%	7.9	3.3	A
	Right Turn	3	3	87.7%	2.4	2.6	A
	Subtotal	655	587	89.6%	7.9	3.2	A
Total		1,059	985	93.0%	6.6	2.6	A

SimTraffic Post-Processor
Average Results from 10 Runs
Volume and Delay by Movement

Vision Zero Top 5 Corridors - Broadway & Stockton BI
Broadway/Stockton Blvd Road Diet
PM Peak Hour

Intersection 21 Santa Cruz Wy/Broadway Side-street Stop

Direction	Movement	Demand Volume (vph)	Served Volume (vph)		Total Delay (sec/veh)		
			Average	Percent	Average	Std. Dev.	LOS
NB	Left Turn	2	2	75.2%	7.8	12.9	A
	Through						
	Right Turn	5	6	112.8%	2.0	1.6	A
	Subtotal	7	7	102.1%	6.0	6.0	A
SB	Left Turn	3	2	62.7%	5.2	9.0	A
	Through						
	Right Turn	3	4	125.3%	6.1	6.7	A
	Subtotal	6	6	94.0%	7.5	6.0	A
EB	Left Turn	3	3	112.8%	2.3	4.2	A
	Through	357	361	101.1%	0.8	0.2	A
	Right Turn	5	6	112.8%	0.6	0.1	A
	Subtotal	365	370	101.4%	0.8	0.3	A
WB	Left Turn	6	5	81.5%	3.0	3.6	A
	Through	640	594	92.8%	0.8	0.3	A
	Right Turn						
	Subtotal	646	599	92.7%	0.8	0.3	A
Total		1,024	981	95.8%	0.9	0.1	A

Intersection 22 42nd St/Broadway Signal

Direction	Movement	Demand Volume (vph)	Served Volume (vph)		Total Delay (sec/veh)		
			Average	Percent	Average	Std. Dev.	LOS
NB	Left Turn	9	8	87.7%	29.5	18.0	C
	Through	10	10	97.8%	23.3	18.1	C
	Right Turn	10	8	82.7%	8.9	6.6	A
	Subtotal	29	26	89.5%	24.6	9.3	C
SB	Left Turn	7	4	59.1%	13.0	11.8	B
	Through	9	11	117.0%	29.0	19.1	C
	Right Turn	13	11	83.9%	10.6	12.0	B
	Subtotal	29	26	88.2%	19.9	9.1	B
EB	Left Turn	9	9	100.3%	5.1	3.6	A
	Through	325	333	102.5%	3.2	1.9	A
	Right Turn	22	23	106.0%	2.9	3.2	A
	Subtotal	356	365	102.7%	3.2	1.8	A
WB	Left Turn	22	21	94.0%	7.6	3.1	A
	Through	635	593	93.4%	4.2	1.2	A
	Right Turn	6	5	81.5%	1.5	2.5	A
	Subtotal	663	619	93.3%	4.3	1.2	A
Total		1,077	1,036	96.2%	4.9	1.3	A

SimTraffic Post-Processor
Average Results from 10 Runs
Volume and Delay by Movement

Vision Zero Top 5 Corridors - Broadway & Stockton Bl
Broadway/Stockton Blvd Road Diet
PM Peak Hour

Intersection 23 43rd St/Broadway Side-street Stop

Direction	Movement	Demand Volume (vph)	Served Volume (vph)		Total Delay (sec/veh)		
			Average	Percent	Average	Std. Dev.	LOS
NB	Left Turn	4	2	47.0%	3.3	4.4	A
	Through	1	0	37.6%	0.5	1.5	A
	Right Turn	7	5	69.8%	4.5	4.1	A
	Subtotal	12	7	59.5%	4.8	3.6	A
SB	Left Turn	2	3	150.4%	10.0	10.8	A
	Through						
	Right Turn	4	5	131.6%	4.4	3.9	A
	Subtotal	6	8	137.9%	8.6	4.7	A
EB	Left Turn	4	5	112.8%	5.9	5.6	A
	Through	333	338	101.6%	1.2	0.4	A
	Right Turn	5	4	75.2%	0.6	0.7	A
	Subtotal	342	347	101.4%	1.3	0.5	A
WB	Left Turn	12	7	56.4%	3.5	1.9	A
	Through	655	605	92.4%	2.3	0.7	A
	Right Turn	8	9	117.5%	2.0	0.6	A
	Subtotal	675	622	92.1%	2.3	0.7	A
Total		1,035	984	95.0%	2.0	0.4	A

Intersection 24 Stockton Bl/Broadway Signal

Direction	Movement	Demand Volume (vph)	Served Volume (vph)		Total Delay (sec/veh)		
			Average	Percent	Average	Std. Dev.	LOS
NB	Left Turn	10	11	105.3%	47.5	24.9	D
	Through	220	214	97.2%	37.7	4.5	D
	Right Turn	86	91	105.4%	10.0	4.7	A
	Subtotal	316	315	99.7%	29.8	3.4	C
SB	Left Turn	208	182	87.3%	136.4	49.3	F
	Through	581	527	90.7%	125.7	46.8	F
	Right Turn	187	157	83.8%	112.4	46.0	F
	Subtotal	976	865	88.6%	125.7	47.3	F
EB	Left Turn	65	70	107.0%	53.9	8.2	D
	Through	216	202	93.5%	39.5	4.1	D
	Right Turn	50	51	101.5%	19.7	4.1	B
	Subtotal	331	322	97.4%	39.4	4.1	D
WB	Left Turn	179	158	88.2%	111.4	33.3	F
	Through	466	404	86.7%	73.1	35.8	E
	Right Turn	185	177	95.7%	56.3	39.2	E
	Subtotal	830	739	89.1%	77.1	35.7	E
Total		2,453	2,242	91.4%	83.4	20.3	F

SimTraffic Post-Processor
Average Results from 10 Runs
Volume and Delay by Movement

Vision Zero Top 5 Corridors - Broadway & Stockton BI
Broadway/Stockton Blvd Road Diet
PM Peak Hour

Intersection 25 **Stockton BI/7th Av** **Side-street Stop**

Direction	Movement	Demand Volume (vph)	Served Volume (vph)		Total Delay (sec/veh)		
			Average	Percent	Average	Std. Dev.	LOS
NB	Left Turn	12	13	108.9%	14.5	8.1	B
	Through	277	277	99.9%	2.6	1.3	A
	Right Turn	5	5	97.8%	0.7	0.4	A
	Subtotal	294	295	100.2%	3.0	1.5	A
SB	Left Turn	17	14	84.0%	4.5	1.8	A
	Through	835	746	89.3%	1.6	0.3	A
	Right Turn	6	6	94.0%	0.2	0.3	A
	Subtotal	858	766	89.2%	1.7	0.3	A
EB	Left Turn	5	3	52.6%	8.2	14.9	A
	Through	0	0	0.0%	0.0	0.0	A
	Right Turn	7	6	85.9%	5.7	4.7	A
	Subtotal	12	9	72.1%	6.9	4.7	A
WB	Left Turn	2	2	75.2%	8.2	18.4	A
	Through	0	0	0.0%	0.8	2.6	A
	Right Turn	7	5	68.5%	3.5	2.5	A
	Subtotal	9	6	71.0%	7.4	8.6	A
Total		1,173	1,075	91.7%	2.2	0.5	A

Intersection 26 **Stockton BI/9th Av** **Side-street Stop**

Direction	Movement	Demand Volume (vph)	Served Volume (vph)		Total Delay (sec/veh)		
			Average	Percent	Average	Std. Dev.	LOS
NB	Left Turn	9	11	126.4%	6.3	5.7	A
	Through	267	256	95.8%	0.7	0.2	A
	Right Turn	4	4	94.0%	0.0	0.0	A
	Subtotal	280	271	96.7%	1.0	0.6	A
SB	Left Turn	28	23	81.6%	4.7	5.1	A
	Through	806	713	88.5%	1.0	0.2	A
	Right Turn	24	23	95.6%	0.0	0.0	A
	Subtotal	858	759	88.5%	1.1	0.2	A
EB	Left Turn	8	9	108.1%	13.9	14.3	B
	Through	1	0	47.0%	5.2	5.9	A
	Right Turn	17	16	94.6%	9.4	3.7	A
	Subtotal	26	25	96.9%	12.0	5.2	B
WB	Left Turn	3	2	62.7%	3.8	8.3	A
	Through	1	1	65.8%	7.4	7.8	A
	Right Turn	18	21	117.5%	4.1	1.6	A
	Subtotal	22	24	107.7%	4.5	1.9	A
Total		1,186	1,079	91.0%	1.4	0.3	A

SimTraffic Post-Processor
Average Results from 10 Runs
Volume and Delay by Movement

Vision Zero Top 5 Corridors - Broadway & Stockton Bl
Broadway/Stockton Blvd Road Diet
PM Peak Hour

Intersection 27 **Stockton Bl/11th Av** **Side-street Stop**

Direction	Movement	Demand Volume (vph)	Served Volume (vph)		Total Delay (sec/veh)		
			Average	Percent	Average	Std. Dev.	LOS
NB	Left Turn	12	11	93.2%	6.1	3.8	A
	Through	278	263	94.5%	0.5	0.2	A
	Right Turn	1	1	75.2%	0.0	0.0	A
	Subtotal	291	275	94.4%	0.8	0.3	A
SB	Left Turn	21	17	80.6%	4.5	2.9	A
	Through	780	697	89.3%	2.5	2.3	A
	Right Turn	10	6	60.2%	0.0	0.0	A
	Subtotal	811	720	88.7%	2.5	2.3	A
EB	Left Turn	5	5	105.3%	8.3	6.7	A
	Through	0	0	0.0%	0.0	0.0	A
	Right Turn	9	11	117.0%	9.8	5.7	A
	Subtotal	14	16	112.8%	10.1	4.2	B
WB	Left Turn	8	6	75.2%	3.2	3.8	A
	Through	0	0	0.0%	0.0	0.0	A
	Right Turn	5	4	88.4%	2.2	1.7	A
	Subtotal	13	11	81.0%	3.8	2.5	A
Total		1,129	1,021	90.4%	2.2	1.6	A

Intersection 28 **Stockton Bl/14th Av** **Signal**

Direction	Movement	Demand Volume (vph)	Served Volume (vph)		Total Delay (sec/veh)		
			Average	Percent	Average	Std. Dev.	LOS
NB	Left Turn	170	154	90.7%	104.0	52.3	F
	Through	255	234	91.9%	29.6	10.2	C
	Right Turn	81	77	94.7%	10.8	5.3	B
	Subtotal	506	465	91.9%	51.7	24.3	D
SB	Left Turn	30	24	79.0%	101.3	16.6	F
	Through	703	562	79.9%	72.5	13.8	E
	Right Turn	16	10	61.1%	64.1	24.2	E
	Subtotal	749	595	79.5%	73.7	13.8	E
EB	Left Turn	23	25	109.5%	44.1	6.8	D
	Through	163	190	116.7%	50.1	8.8	D
	Right Turn	94	97	103.2%	40.7	7.5	D
	Subtotal	280	312	111.6%	46.8	6.9	D
WB	Left Turn	100	93	92.9%	54.2	12.4	D
	Through	250	252	100.8%	59.0	13.6	E
	Right Turn	44	47	107.7%	49.5	19.4	D
	Subtotal	394	392	99.5%	56.7	13.5	E
Total		1,129	1,086	96.2%	59.4	6.5	E

SimTraffic Post-Processor
Average Results from 10 Runs
Volume and Delay by Movement

Vision Zero Top 5 Corridors - Broadway & Stockton Bl
Broadway/Stockton Blvd Road Diet
PM Peak Hour

Intersection 113

San Diego Wy/Broadway

Signal

Direction	Movement	Demand Volume (vph)	Served Volume (vph)		Total Delay (sec/veh)		LOS
			Average	Percent	Average	Std. Dev.	
NB	Left Turn	5	5	97.8%	17.2	15.9	B
	Through	2	3	169.2%	17.7	19.6	B
	Right Turn	5	4	82.7%	2.5	2.5	A
	Subtotal	12	12	103.4%	17.6	11.2	B
SB	Left Turn	24	28	115.9%	27.6	9.3	C
	Through	2	2	112.8%	19.9	24.6	B
	Right Turn	92	92	99.7%	12.4	3.8	B
	Subtotal	118	122	103.2%	16.8	5.3	B
EB	Left Turn	40	37	92.1%	13.8	5.7	B
	Through	302	309	102.3%	3.8	1.0	A
	Right Turn						
	Subtotal	342	346	101.1%	4.9	1.3	A
WB	Left Turn	5	3	60.2%	4.3	4.9	A
	Through	578	513	88.8%	6.8	2.3	A
	Right Turn	80	67	83.2%	4.8	1.8	A
	Subtotal	663	583	87.9%	6.6	2.2	A
Total		1,135	1,063	93.7%	7.3	1.4	A

SimTraffic Post-Processor
Average Results from 10 Runs
Volume and Delay by Movement

Vision Zero Top 5 Corridors - Broadway & Stockton Bl
Broadway/Stockton Blvd Road Diet
PM Peak Hour

Intersection 114

6th Av/Stockton Bl

Signal

Direction	Movement	Demand Volume (vph)	Served Volume (vph)		Total Delay (sec/veh)		
			Average	Percent	Average	Std. Dev.	LOS
NB	Left Turn	5	3	60.2%	3.8	5.5	A
	Through	274	273	99.6%	3.8	1.5	A
	Right Turn	10	10	101.5%	2.3	2.4	A
	Subtotal	289	286	99.0%	3.7	1.4	A
SB	Left Turn	40	34	84.6%	9.0	2.8	A
	Through	765	683	89.3%	6.0	0.8	A
	Right Turn	5	6	127.8%	2.8	1.5	A
	Subtotal	810	723	89.3%	6.2	0.6	A
EB	Left Turn	5	5	97.8%	18.1	15.4	B
	Through	2	2	75.2%	10.4	14.5	B
	Right Turn	5	4	75.2%	8.4	8.5	A
	Subtotal	12	10	84.6%	16.4	10.8	B
WB	Left Turn	88	88	100.4%	24.0	5.1	C
	Through	2	2	112.8%	17.7	23.7	B
	Right Turn	37	36	97.6%	12.4	5.5	B
	Subtotal	127	127	99.8%	20.8	4.4	C
Total		1,238	1,146	92.6%	7.3	0.8	A

S Stockton Boulevard

Vision Zero Top 5 Corridor Recommendations Results Summary – Stockton Boulevard (South)

Peak Hour Maximum Queue Results – Stockton Boulevard/47th Avenue/Elder Creek Road

Approach	Lane	Storage (ft)	Peak Hour Maximum Queue (ft)	
			AM Peak Hour	PM Peak Hour
NB	Left	250	250	275
	Through	1,675	325	350
	Through/Right	1,675	350	325
SB	Left	225	175	325
	Through	1,950	300	600
	Through/Right	1,950	350	575
EB	Left	300	350	325
	Through	550	575	400
	Right	550	500	375
WB	Left	175	150	200
	Through	2,275	300	450
	Through/Right	2,275	325	450

Arterial Level of Service: NB Stockton BI

Cross Street	Node	Delay (s/veh)	Travel time (s)	Dist (mi)	Arterial Speed
Riza Av	108	10.5	25.7	0.2	24
Fowler Av	34	1.9	5.0	0.0	29
48th Av	123	6.1	29.0	0.3	32
Elder Creek Rd	33	31.0	37.4	0.1	7
Dias Av	32	11.1	22.5	0.1	20
El Paraiso Av	107	3.0	15.8	0.1	28
Lemon Hill Av	31	28.2	41.9	0.1	12
	106	5.1	19.6	0.1	26
McMahon Dr	30	7.3	15.6	0.1	18
	29	2.1	8.7	0.1	27
Jansen Dr	136	9.8	22.7	0.1	20
Total		116.0	243.9	1.4	20

Arterial Level of Service: SB Stockton BI

Cross Street	Node	Delay (s/veh)	Travel time (s)	Dist (mi)	Arterial Speed
	136	5.4	48.1	0.4	33
37th Av	29	1.5	14.5	0.1	32
	30	4.2	11.0	0.1	21
	106	1.1	8.9	0.1	32
Lemon Hill Av	31	17.9	31.9	0.1	16
El Paraiso Av	107	2.3	16.8	0.1	30
	32	5.2	17.9	0.1	25
47th Av	33	29.8	40.5	0.1	11
	123	3.2	10.4	0.1	26
Fowler Av	34	7.9	30.9	0.3	30
Riza Av	108	1.3	4.3	0.0	33
Total		79.7	235.4	1.6	25

Arterial Level of Service: NB Stockton Bl

Cross Street	Node	Delay (s/veh)	Travel time (s)	Dist (mi)	Arterial Speed
Riza Av	108	10.4	25.6	0.2	24
Fowler Av	34	2.1	5.1	0.0	28
48th Av	123	2.6	25.5	0.3	37
Elder Creek Rd	33	30.6	37.0	0.1	7
Dias Av	32	8.6	19.7	0.1	23
El Paraiso Av	107	1.9	14.6	0.1	30
Lemon Hill Av	31	21.0	34.5	0.1	15
	106	4.3	18.8	0.1	27
McMahon Dr	30	9.3	17.7	0.1	16
	29	1.9	8.5	0.1	27
Jansen Dr	136	9.5	22.5	0.1	21
Total		102.1	229.6	1.4	21

Arterial Level of Service: SB Stockton Bl

Cross Street	Node	Delay (s/veh)	Travel time (s)	Dist (mi)	Arterial Speed
	136	8.1	50.7	0.4	31
37th Av	29	3.6	16.5	0.1	28
	30	7.2	14.0	0.1	17
	106	2.1	9.9	0.1	29
Lemon Hill Av	31	18.7	32.6	0.1	16
El Paraiso Av	107	3.3	17.9	0.1	29
	32	8.3	21.1	0.1	21
47th Av	33	39.2	49.8	0.1	9
	123	5.0	12.2	0.1	23
Fowler Av	34	13.5	36.6	0.3	26
Riza Av	108	2.5	5.5	0.0	26
Total		111.4	266.8	1.6	22

Arterial Level of Service
 Vision Zero Top 5 Recommendations

AM Peak Hour
 Vision Zero - Top 5 Corridors

Arterial Level of Service: NB Stockton BI

Cross Street	Node	Delay (s/veh)	Travel time (s)	Dist (mi)	Arterial Speed
Riza Av	108	13.6	28.8	0.2	22
Fowler Av	34	2.0	5.1	0.0	28
48th Av	123	8.9	31.9	0.3	29
Elder Creek Rd	33	30.3	36.7	0.1	8
Dias Av	32	7.4	18.9	0.1	24
El Paraiso Av	107	2.4	15.2	0.1	29
Lemon Hill Av	31	38.7	52.2	0.1	10
	106	4.8	19.3	0.1	26
McMahon Dr	30	5.2	13.6	0.1	21
	29	1.8	8.4	0.1	28
Jansen Dr	136	10.1	23.1	0.1	20
Total		125.4	253.2	1.4	19

Arterial Level of Service: SB Stockton BI

Cross Street	Node	Delay (s/veh)	Travel time (s)	Dist (mi)	Arterial Speed
	136	5.4	48.3	0.4	33
37th Av	29	1.5	14.5	0.1	32
	30	2.9	9.7	0.1	24
	106	0.8	8.6	0.1	33
Lemon Hill Av	31	21.5	35.6	0.1	14
El Paraiso Av	107	2.5	16.9	0.1	30
	32	4.5	17.2	0.1	26
47th Av	33	42.6	52.8	0.1	9
	123	3.6	10.9	0.1	25
Fowler Av	34	20.5	43.4	0.3	22
Riza Av	108	2.2	5.3	0.0	27
Total		107.9	263.0	1.6	22

Arterial Level of Service
 Vision Zero Top 5 Recommendations

PM Peak Hour
 Vision Zero - Top 5 Corridors

Arterial Level of Service: NB Stockton Bl

Cross Street	Node	Delay (s/veh)	Travel time (s)	Dist (mi)	Arterial Speed
Riza Av	108	12.5	27.8	0.2	23
Fowler Av	34	2.4	5.5	0.0	26
48th Av	123	6.6	29.5	0.3	32
Elder Creek Rd	33	33.4	39.6	0.1	7
Dias Av	32	6.5	18.4	0.1	25
El Paraiso Av	107	1.4	14.1	0.1	31
Lemon Hill Av	31	23.6	37.3	0.1	14
	106	4.8	19.5	0.1	26
McMahon Dr	30	7.9	16.2	0.1	18
	29	1.6	8.3	0.1	28
Jansen Dr	136	9.1	21.8	0.1	21
Total		109.8	237.8	1.4	20

Arterial Level of Service: SB Stockton Bl

Cross Street	Node	Delay (s/veh)	Travel time (s)	Dist (mi)	Arterial Speed
	136	8.5	51.1	0.4	31
37th Av	29	3.5	16.5	0.1	28
	30	8.2	14.9	0.1	16
	106	2.1	10.0	0.1	29
Lemon Hill Av	31	14.4	28.6	0.1	18
El Paraiso Av	107	5.3	19.7	0.1	26
	32	27.6	40.1	0.1	11
47th Av	33	72.9	82.7	0.1	5
	123	4.6	11.8	0.1	23
Fowler Av	34	8.6	31.4	0.3	30
Riza Av	108	2.2	5.2	0.0	28
Total		157.8	311.9	1.6	19

SimTraffic Post-Processor
Average Results from 10 Runs
Volume and Delay by Movement

Vision Zero Top 5 Corridors - Stockton BI
VZ Recommendations
AM Peak Hour

Intersection 29 Stockton BI/37th Av Side-street Stop

Direction	Movement	Demand Volume (vph)	Served Volume (vph)		Total Delay (sec/veh)		
			Average	Percent	Average	Std. Dev.	LOS
NB	Left Turn	40	37	91.7%	4.5	1.6	A
	Through	1,178	1,069	90.8%	1.8	0.4	A
	Right Turn						
	Subtotal	1,218	1,106	90.8%	1.8	0.4	A
SB	Left Turn						
	Through	552	559	101.3%	1.5	0.3	A
	Right Turn	19	19	97.4%	1.1	0.6	A
	Subtotal	571	577	101.1%	1.4	0.2	A
EB	Left Turn	45	50	110.8%	18.7	3.3	C
	Through						
	Right Turn	47	47	99.2%	9.7	4.7	A
	Subtotal	92	96	104.9%	14.3	3.2	B
WB	Left Turn						
	Through						
	Right Turn						
	Subtotal						
Total		1,881	1,780	94.6%	2.4	0.3	A

Intersection 30 Stockton BI/McMahon Dr Signal

Direction	Movement	Demand Volume (vph)	Served Volume (vph)		Total Delay (sec/veh)		
			Average	Percent	Average	Std. Dev.	LOS
NB	Left Turn	1	0	35.6%	5.8	18.3	A
	Through	1,163	1,040	89.4%	5.2	1.0	A
	Right Turn	52	57	110.2%	4.3	2.1	A
	Subtotal	1,216	1,097	90.2%	5.2	0.9	A
SB	Left Turn	36	35	95.9%	51.2	9.9	D
	Through	550	546	99.3%	3.1	0.9	A
	Right Turn	13	15	117.8%	2.2	2.3	A
	Subtotal	599	596	99.5%	5.8	1.3	A
EB	Left Turn	3	2	59.3%	17.8	26.8	B
	Through	6	7	112.7%	51.4	32.8	D
	Right Turn	4	5	133.5%	10.7	12.6	B
	Subtotal	13	14	106.8%	36.3	18.1	D
WB	Left Turn	60	63	105.0%	47.2	7.2	D
	Through	9	8	87.0%	37.1	24.0	D
	Right Turn	52	51	97.2%	28.8	7.1	C
	Subtotal	121	121	100.3%	39.0	5.1	D
Total		1,949	1,828	93.8%	7.9	0.9	A

SimTraffic Post-Processor
Average Results from 10 Runs
Volume and Delay by Movement

Vision Zero Top 5 Corridors - Stockton BI
VZ Recommendations
AM Peak Hour

Intersection 31 Stockton BI/Lemon Hill Av Signal

Direction	Movement	Demand Volume (vph)	Served Volume (vph)		Total Delay (sec/veh)		
			Average	Percent	Average	Std. Dev.	LOS
NB	Left Turn	37	42	112.6%	69.0	23.9	E
	Through	1,037	917	88.4%	41.1	16.2	D
	Right Turn	108	94	86.7%	17.0	13.0	B
	Subtotal	1,182	1,052	89.0%	40.0	16.0	D
SB	Left Turn	108	109	100.5%	51.7	5.7	D
	Through	455	455	99.9%	21.8	4.0	C
	Right Turn	51	52	101.2%	19.2	4.3	B
	Subtotal	614	615	100.1%	26.9	4.4	C
EB	Left Turn	47	41	87.9%	42.4	11.4	D
	Through	109	108	99.0%	45.1	3.2	D
	Right Turn	29	27	94.5%	7.9	2.8	A
	Subtotal	185	177	95.4%	38.6	3.9	D
WB	Left Turn	102	112	109.6%	40.0	6.2	D
	Through	93	87	93.0%	40.4	4.5	D
	Right Turn	158	156	98.9%	16.8	3.8	B
	Subtotal	353	355	100.4%	29.9	2.1	C
Total		2,334	2,198	94.2%	34.5	8.1	C

Intersection 32 Stockton BI/Dias Av Signal

Direction	Movement	Demand Volume (vph)	Served Volume (vph)		Total Delay (sec/veh)		
			Average	Percent	Average	Std. Dev.	LOS
NB	Left Turn	19	17	88.1%	10.1	5.2	B
	Through	1,206	1,099	91.1%	6.2	1.7	A
	Right Turn	2	1	35.6%	0.1	0.3	A
	Subtotal	1,227	1,116	91.0%	6.3	1.7	A
SB	Left Turn	20	17	87.2%	19.1	10.8	B
	Through	558	554	99.2%	4.6	2.1	A
	Right Turn	17	19	113.1%	3.5	3.4	A
	Subtotal	595	590	99.2%	4.9	2.2	A
EB	Left Turn	2	1	71.2%	12.5	19.9	B
	Through						
	Right Turn	8	7	84.6%	3.7	3.2	A
	Subtotal	10	8	81.9%	11.9	14.5	B
WB	Left Turn	37	34	91.4%	23.6	6.8	C
	Through	1	1	71.2%	10.3	21.9	B
	Right Turn	54	52	96.9%	12.7	3.5	B
	Subtotal	92	87	94.4%	17.5	3.8	B
Total		1,924	1,802	93.6%	6.4	1.5	A

SimTraffic Post-Processor
Average Results from 10 Runs
Volume and Delay by Movement

Vision Zero Top 5 Corridors - Stockton BI
VZ Recommendations
AM Peak Hour

Intersection 33 Stockton BI/47th Av-Elder Creek Rd Signal

Direction	Movement	Demand Volume (vph)	Served Volume (vph)		Total Delay (sec/veh)		
			Average	Percent	Average	Std. Dev.	LOS
NB	Left Turn	222	204	92.0%	52.6	16.3	D
	Through	908	852	93.8%	38.8	15.2	D
	Right Turn	50	46	92.6%	33.3	11.8	C
	Subtotal	1,180	1,102	93.4%	41.2	15.0	D
SB	Left Turn	87	87	100.3%	43.0	6.0	D
	Through	331	352	106.4%	42.4	4.0	D
	Right Turn	189	199	105.5%	36.4	7.3	D
	Subtotal	607	639	105.2%	40.6	3.9	D
EB	Left Turn	222	220	98.9%	129.5	43.4	F
	Through	572	518	90.6%	39.3	8.4	D
	Right Turn	113	112	99.6%	28.4	7.1	C
	Subtotal	907	850	93.7%	61.0	16.2	E
WB	Left Turn	25	25	101.1%	50.8	16.5	D
	Through	635	572	90.1%	43.0	4.7	D
	Right Turn	101	93	92.0%	37.1	5.9	D
	Subtotal	761	690	90.7%	42.6	4.6	D
Total		3,455	3,281	95.0%	46.7	5.8	D

Intersection 34 Stockton BI/Riza Av-Fowler Av Signal

Direction	Movement	Demand Volume (vph)	Served Volume (vph)		Total Delay (sec/veh)		
			Average	Percent	Average	Std. Dev.	LOS
NB	Left Turn	15	13	87.8%	61.1	29.1	E
	Through	1,090	1,070	98.1%	15.9	2.3	B
	Right Turn	29	37	127.4%	14.4	2.3	B
	Subtotal	1,134	1,120	98.8%	16.5	2.5	B
SB	Left Turn	18	16	91.0%	45.8	24.1	D
	Through	403	396	98.3%	24.4	5.1	C
	Right Turn	15	15	103.2%	21.6	4.5	C
	Subtotal	436	428	98.2%	25.0	4.5	C
EB	Left Turn	28	20	70.9%	38.9	10.1	D
	Through	1	0	44.5%	37.4	10.0	D
	Right Turn	22	22	98.7%	4.0	1.6	A
	Subtotal	51	42	82.4%	20.5	8.1	C
WB	Left Turn	41	42	102.0%	52.3	12.8	D
	Through	1	2	160.2%	49.5	13.2	D
	Right Turn	34	40	116.2%	11.2	3.6	B
	Subtotal	76	83	109.1%	33.3	10.3	C
Total		1,697	1,673	98.6%	19.6	2.5	B

SimTraffic Post-Processor
Average Results from 10 Runs
Volume and Delay by Movement

Vision Zero Top 5 Corridors - Stockton BI
VZ Top 5 Recommendations
PM Peak Hour

Intersection 29 Stockton BI/37th Av Side-street Stop

Direction	Movement	Demand Volume (vph)	Served Volume (vph)		Total Delay (sec/veh)		
			Average	Percent	Average	Std. Dev.	LOS
NB	Left Turn	37	35	95.5%	11.3	4.2	B
	Through	797	766	96.1%	1.5	0.3	A
	Right Turn						
	Subtotal	834	801	96.1%	1.9	0.5	A
SB	Left Turn	4	3	76.0%	2.6	3.6	A
	Through	1,131	1,150	101.7%	3.4	0.3	A
	Right Turn	109	108	99.0%	2.8	0.8	A
	Subtotal	1,244	1,261	101.4%	3.3	0.3	A
EB	Left Turn	48	60	124.3%	49.3	36.3	E
	Through						
	Right Turn	41	37	89.9%	30.8	20.7	D
	Subtotal	89	97	108.4%	42.4	30.4	E
WB	Left Turn	8	8	95.0%	35.6	27.2	E
	Through						
	Right Turn	6	5	76.0%	5.8	7.7	A
	Subtotal	14	12	86.9%	28.9	20.6	D
Total		2,181	2,171	99.5%	4.7	1.4	A

Intersection 30 Stockton BI/McMahon Dr Signal

Direction	Movement	Demand Volume (vph)	Served Volume (vph)		Total Delay (sec/veh)		
			Average	Percent	Average	Std. Dev.	LOS
NB	Left Turn	12	11	95.0%	34.0	13.1	C
	Through	742	695	93.7%	7.8	1.9	A
	Right Turn	58	60	103.5%	8.4	4.2	A
	Subtotal	812	767	94.4%	8.2	1.9	A
SB	Left Turn	32	31	97.4%	33.7	7.2	C
	Through	1,123	1,151	102.5%	8.2	1.1	A
	Right Turn	25	24	94.2%	5.9	4.6	A
	Subtotal	1,180	1,206	102.2%	8.8	1.0	A
EB	Left Turn	64	70	109.3%	23.9	6.1	C
	Through	17	14	84.9%	18.2	10.4	B
	Right Turn	38	36	95.0%	11.4	3.8	B
	Subtotal	119	120	101.2%	19.9	4.8	B
WB	Left Turn	48	48	99.8%	24.1	8.3	C
	Through	17	19	111.8%	25.9	11.6	C
	Right Turn	28	30	107.2%	9.9	2.9	A
	Subtotal	93	97	104.2%	19.6	5.2	B
Total		2,204	2,190	99.4%	9.7	1.0	A

SimTraffic Post-Processor
Average Results from 10 Runs
Volume and Delay by Movement

Vision Zero Top 5 Corridors - Stockton Bl
VZ Top 5 Recommendations
PM Peak Hour

Intersection 31 Stockton Bl/Lemon Hill Av Signal

Direction	Movement	Demand Volume (vph)	Served Volume (vph)		Total Delay (sec/veh)		
			Average	Percent	Average	Std. Dev.	LOS
NB	Left Turn	25	23	91.2%	74.3	26.4	E
	Through	727	657	90.4%	23.5	3.4	C
	Right Turn	74	65	87.8%	6.2	1.7	A
	Subtotal	826	745	90.2%	23.4	3.1	C
SB	Left Turn	120	123	102.6%	63.1	7.4	E
	Through	1,061	1,041	98.1%	14.6	2.2	B
	Right Turn	57	52	90.7%	11.4	3.9	B
	Subtotal	1,238	1,216	98.2%	19.3	2.4	B
EB	Left Turn	64	74	115.8%	48.6	9.7	D
	Through	64	72	112.8%	53.8	6.8	D
	Right Turn	39	40	103.3%	12.7	4.4	B
	Subtotal	167	187	111.7%	42.7	6.0	D
WB	Left Turn	114	116	102.0%	48.9	6.4	D
	Through	123	127	102.9%	55.6	7.7	E
	Right Turn	107	97	90.9%	15.6	2.4	B
	Subtotal	344	340	98.9%	42.0	5.4	D
Total		2,575	2,487	96.6%	25.4	1.9	C

Intersection 32 Stockton Bl/Dias Av Signal

Direction	Movement	Demand Volume (vph)	Served Volume (vph)		Total Delay (sec/veh)		
			Average	Percent	Average	Std. Dev.	LOS
NB	Left Turn	40	37	93.1%	31.0	15.8	C
	Through	832	826	99.2%	5.4	0.8	A
	Right Turn	1	2	152.0%	1.1	1.9	A
	Subtotal	873	865	99.0%	6.4	0.9	A
SB	Left Turn	39	34	87.7%	30.0	20.5	C
	Through	1,202	1,120	93.2%	27.1	16.2	C
	Right Turn	38	36	94.0%	29.4	23.4	C
	Subtotal	1,279	1,190	93.1%	27.2	16.3	C
EB	Left Turn	6	4	63.3%	17.4	19.5	B
	Through	1	1	76.0%	9.1	19.5	A
	Right Turn	13	13	102.3%	19.8	14.6	B
	Subtotal	20	18	89.3%	24.3	11.7	C
WB	Left Turn	64	62	97.4%	32.5	5.6	C
	Through	2	2	114.0%	11.2	19.8	B
	Right Turn	29	31	106.1%	19.3	8.3	B
	Subtotal	95	95	100.4%	28.2	5.0	C
Total		2,267	2,168	95.6%	19.0	9.4	B

SimTraffic Post-Processor
Average Results from 10 Runs
Volume and Delay by Movement

Vision Zero Top 5 Corridors - Stockton BI
VZ Top 5 Recommendations
PM Peak Hour

Intersection 33 Stockton BI/47th Av-Elder Creek Rd Signal

Direction	Movement	Demand Volume (vph)	Served Volume (vph)		Total Delay (sec/veh)		
			Average	Percent	Average	Std. Dev.	LOS
NB	Left Turn	214	191	89.1%	114.0	30.9	F
	Through	532	570	107.1%	39.8	5.8	D
	Right Turn	64	69	108.1%	34.1	5.9	C
	Subtotal	810	830	102.5%	56.9	10.9	E
SB	Left Turn	146	123	84.1%	86.0	15.7	F
	Through	830	779	93.9%	72.9	15.0	E
	Right Turn	316	290	91.6%	81.6	18.9	F
	Subtotal	1,292	1,191	92.2%	76.4	15.4	E
EB	Left Turn	241	193	80.1%	95.0	31.8	F
	Through	490	434	88.5%	40.1	4.9	D
	Right Turn	200	181	90.6%	30.1	5.8	C
	Subtotal	931	808	86.8%	51.4	11.3	D
WB	Left Turn	92	90	98.3%	95.7	10.8	F
	Through	803	706	87.9%	60.1	8.9	E
	Right Turn	116	115	98.9%	53.4	9.4	D
	Subtotal	1,011	911	90.1%	63.0	8.1	E
Total		4,044	3,740	92.5%	63.4	5.3	E

Intersection 34 Stockton BI/Riza Av-Fowler Av Signal

Direction	Movement	Demand Volume (vph)	Served Volume (vph)		Total Delay (sec/veh)		
			Average	Percent	Average	Std. Dev.	LOS
NB	Left Turn	30	32	107.7%	52.1	14.0	D
	Through	749	719	95.9%	15.9	1.8	B
	Right Turn	60	65	107.5%	13.9	1.6	B
	Subtotal	839	815	97.2%	17.2	1.6	B
SB	Left Turn	30	31	102.6%	82.9	15.2	F
	Through	1,025	855	83.4%	13.8	2.7	B
	Right Turn	27	24	90.1%	12.3	3.9	B
	Subtotal	1,082	910	84.1%	16.0	2.6	B
EB	Left Turn	17	23	135.8%	50.9	17.7	D
	Through	1	2	199.5%	49.0	17.5	D
	Right Turn	26	25	95.0%	13.9	6.4	B
	Subtotal	44	50	113.1%	32.3	7.7	C
WB	Left Turn	100	102	102.2%	49.7	11.2	D
	Through	3	3	101.3%	48.2	11.4	D
	Right Turn	31	35	111.5%	11.1	8.3	B
	Subtotal	134	140	104.4%	40.6	12.0	D
Total		2,099	1,915	91.2%	18.7	2.2	B

Direction	Lane Group	Storage (ft)	Average Queue (ft)		95th Queue (ft)		Maximum Queue (ft)		Block Time	
			Average	Std. Dev.	Average	Std. Dev.	Average	Std. Dev.	Pocket	Upstream
EB	U/Left Turns	300	300	35	400	40	350	16	41%	0%
	Through	1,600	375	183	600	242	575	216	0%	0%
	Through/Right	1,600	325	171	525	281	500	239	0%	0%
NB	U/Left Turns	250	175	32	300	35	250	32	2%	0%
	Through	300	225	38	350	48	325	30	12%	7%
	Through/Right	300	250	34	375	44	350	28	0%	9%
SB	Left Turn	225	100	25	150	62	175	81	0%	0%
	Through	575	200	31	275	41	300	48	4%	0%
	Through/Right	575	250	34	350	49	350	55	0%	0%
WB	U/Left Turns	175	50	17	125	53	150	73	0%	0%
	Through	2,800	225	27	325	46	300	51	20%	0%
	Through/Right	2,800	250	28	325	45	325	43	0%	0%

SimTraffic Post-Processor
 Average Results from 10 Runs
 Queue Length
 Intersection 33

Stockton Bl/47th Av-Elder Creek Rd

Vision Zero Top 5 Corridors - Stockton Bl
 VZ Top 5 Recommendations
 PM Peak Hour
 Signal

Direction	Lane Group	Storage (ft)	Average Queue (ft)		95th Queue (ft)		Maximum Queue (ft)		Block Time	
			Average	Std. Dev.	Average	Std. Dev.	Average	Std. Dev.	Pocket	Upstream
EB	U/Left Turns	300	250	65	325	78	325	61	17%	0%
	Through	1,600	250	89	400	187	400	136	0%	0%
	Through/Right	1,600	250	76	375	137	375	117	0%	0%
NB	U/Left Turns	250	250	35	300	22	275	2	30%	0%
	Through	300	275	31	375	42	350	33	7%	14%
	Through/Right	300	250	24	325	31	325	29	0%	3%
SB	Left Turn	225	200	48	350	44	325	1	1%	0%
	Through	575	500	69	650	60	600	17	51%	16%
	Through/Right	575	525	62	650	61	575	32	0%	19%
WB	U/Left Turns	175	150	30	225	32	200	1	5%	0%
	Through	2,800	350	41	450	47	450	53	43%	0%
	Through/Right	2,800	375	45	450	42	450	36	0%	0%

Florin Road

Vision Zero Top 5 Corridor Recommendations Results Summary – Florin Road

Vision Zero Top 5 Corridor Recommendations Implemented

- Narrowed lanes on Florin Road between 24th Street and Munson Way
- Longer pedestrian crossing time at 24th Street/Florin Road
- New traffic signals at Loma Verde Way/Florin Road, Serenity Drive/Florin Road, and Munson Way/Florin Road
- Extended signal clearance time at Luther Drive/Florin Road

Speed & Travel Time Results

Travel Times (min)	Dir	Existing Conditions		VZ Recommendations		% Change	
		AM Peak Hour	PM Peak Hour	AM Peak Hour	PM Peak Hour	AM Peak Hour	PM Peak Hour
Florin Road – 24 th Street to Munson Way	EB	4.2	4.0	4.6	4.6	9%	15%
	WB	3.5	3.1	4.1	3.4	17%	7%
Speed (mph)	Dir	Existing Conditions		VZ Recommendations		% Change	
		AM Peak Hour	PM Peak Hour	AM Peak Hour	PM Peak Hour	AM Peak Hour	PM Peak Hour
Florin Road – 24 th Street to Munson Way	EB	23	24	21	21	-9%	-13%
	WB	19	21	16	20	-16%	-5%

Delay & LOS Results

Intersection	Existing Conditions			VZ Recommendations		
	Control ¹	AM Peak Hour	PM Peak Hour	Control	AM Peak Hour	PM Peak Hour
24 th St/Florin Rd	Signal	D / 37	C / 31	Signal	D / 42	C / 33
Woodbine Av/Florin Rd	Signal	A / 10	B / 11	Signal	B / 13	B / 10
Loma Verde Wy/Florin Rd	SSSC	Not Analyzed		Signal	B / 12	A / 5
Indian Ln/29 th St/Florin Rd	Signal	C / 23	C / 20	Signal	C / 29	C / 21
Serenity Dr/Florin Rd	SSSC	Not Analyzed		Signal	B / 18	B / 13
Hispery Ln/Luther Burbank HS Dw/Florin Rd	Signal	B / 13	A / 4	Signal	B / 13	A / 8
Luther Dr/Florin Rd	Signal	D / 49	D / 43	Signal	E / 57	D / 50
Munson Wy/Florin Rd	SSSC	A (B) / 3 (14)	A (C) / 3 (21)	Signal	A / 3	A / 8

Vision Zero Top 5 Corridor Recommendations Results Summary – Florin Road

Peak Hour Maximum Queue Results – El Camino Avenue/Del Paso Boulevard/Beaumont Street

Approach	Lane	Storage (ft)	Peak Hour Maximum Queue (ft)	
			AM Peak Hour	PM Peak Hour
EB	Left	125	100	100
	Through	450	250	350
	Through/Right	450	275	375

Arterial Level of Service: EB Florin Rd

Cross Street	Node	Delay (s/veh)	Travel time (s)	Dist (mi)	Arterial Speed
24th St	35	25.9	69.9	0.5	27
25th St	101	4.0	15.5	0.1	30
	36	2.1	8.2	0.1	30
Loma Verde Wy	102	1.4	13.9	0.1	36
29th St	37	26.9	40.3	0.2	14
HS Dwy	103	7.5	29.3	0.2	30
Luther Burbank HS	39	8.3	15.8	0.1	19
HS Dwy	135	3.7	9.4	0.1	23
Luther Dr	40	20.8	25.9	0.1	8
Luther Dr	105	3.4	7.1	0.0	21
Munson Wy	41	3.2	16.2	0.1	32
	140	0.7	4.4	0.0	31
Franklin Bl	137	33.2	41.2	0.1	9
	138	2.8	7.9	0.0	22
Total		143.8	305.1	1.8	22

Arterial Level of Service: WB Florin Rd

Cross Street	Node	Delay (s/veh)	Travel time (s)	Dist (mi)	Arterial Speed
	138	2.6	33.3	0.4	39
Franklin Bl	137	31.9	36.3	0.0	5
	140	4.7	14.1	0.1	26
	41	0.6	4.0	0.0	34
Luther Dr	105	37.1	50.0	0.1	11
Luther Dr	40	3.3	7.1	0.0	21
HS Dwy	135	2.2	7.8	0.1	28
Hisperry Ln	39	6.6	11.8	0.1	18
Serenity Dr	103	2.0	9.6	0.1	32
Indian Ln	37	14.2	35.3	0.2	25
Loma Verde Wy	102	2.9	16.8	0.2	33
Woodbine Av	36	8.0	20.4	0.1	25
	101	2.1	8.4	0.1	29
24th St	35	29.6	40.7	0.1	11
Total		147.6	295.6	1.7	20

Arterial Level of Service: EB Florin Rd

Cross Street	Node	Delay (s/veh)	Travel time (s)	Dist (mi)	Arterial Speed
24th St	35	28.7	73.3	0.5	26
25th St	101	4.5	16.2	0.1	29
	36	9.4	15.4	0.1	16
Loma Verde Wy	102	3.4	15.9	0.1	32
29th St	37	21.7	35.2	0.2	16
Luther HS Dwy	103	5.2	27.1	0.2	33
Luther Burbank HS	39	1.8	9.3	0.1	32
	135	1.5	7.2	0.1	30
Luther Dr	40	11.9	17.1	0.1	13
Luther Dr	105	2.3	6.1	0.0	25
Munson Wy	41	2.6	15.6	0.1	34
	140	0.7	4.4	0.0	31
Franklin Bl	137	33.6	41.6	0.1	9
	138	2.2	7.4	0.0	24
Total		129.5	291.7	1.8	23

Arterial Level of Service: WB Florin Rd

Cross Street	Node	Delay (s/veh)	Travel time (s)	Dist (mi)	Arterial Speed
	138	17.1	47.6	0.4	27
Franklin Bl	137	32.5	36.9	0.0	5
	140	6.2	15.6	0.1	23
	41	1.2	4.6	0.0	30
Luther Dr	105	29.6	42.5	0.1	12
Luther Dr	40	3.5	7.3	0.0	21
	135	2.1	7.6	0.1	29
Hisperry Ln	39	3.3	8.6	0.1	25
Serenity Dr	103	1.4	9.0	0.1	34
Indian Ln	37	12.5	33.2	0.2	27
Loma Verde Wy	102	3.3	17.4	0.2	32
Woodbine Av	36	3.9	16.4	0.1	31
	101	1.7	8.0	0.1	31
24th St	35	22.9	34.2	0.1	13
Total		141.2	288.9	1.7	21

Arterial Level of Service: EB Florin Rd

Cross Street	Node	Delay (s/veh)	Travel time (s)	Dist (mi)	Arterial Speed
24th St	35	32.2	76.2	0.5	25
25th St	101	4.1	15.9	0.1	29
	36	1.8	7.9	0.1	31
Loma Verde Wy	102	6.4	18.6	0.1	27
29th St	37	34.5	48.3	0.2	12
Serenity Dr	103	16.1	36.9	0.2	24
	155	1.7	3.3	0.0	19
Luther Burbank HS	39	5.4	11.2	0.1	21
HS Dwy	135	3.7	9.3	0.1	23
Luther Dr	40	18.9	24.1	0.1	9
Luther Dr	105	3.8	7.5	0.0	20
Munson Wy	41	4.5	17.6	0.1	30
	140	1.1	4.8	0.0	29
Franklin Bl	137	31.3	39.1	0.1	9
	138	2.9	8.0	0.0	22
Total		168.5	328.6	1.8	20

Arterial Level of Service: WB Florin Rd

Cross Street	Node	Delay (s/veh)	Travel time (s)	Dist (mi)	Arterial Speed
	138	2.7	33.4	0.4	39
Franklin Bl	137	31.0	35.3	0.0	5
	140	6.0	15.3	0.1	24
	41	5.2	8.6	0.0	16
Luther Dr	105	36.0	48.6	0.1	11
Luther Dr	40	3.3	7.1	0.0	21
HS Dwy	135	2.8	8.4	0.1	26
Hisperry Ln	39	6.2	11.5	0.1	19
	155	12.2	18.0	0.1	13
Serenity Dr	103	6.9	8.4	0.0	8
Indian Ln	37	23.5	45.2	0.2	20
Loma Verde Wy	102	11.3	25.4	0.2	22
Woodbine Av	36	5.6	17.7	0.1	28
	101	2.0	8.2	0.1	30
24th St	35	27.6	38.4	0.1	12
Total		182.4	329.6	1.7	18

Arterial Level of Service
 Vision Zero Top 5 Recommendations

PM Peak Hour
 Vision Zero - Top 5 Corridors

Arterial Level of Service: EB Florin Rd

Cross Street	Node	Delay (s/veh)	Travel time (s)	Dist (mi)	Arterial Speed
24th St	35	27.5	71.6	0.5	26
25th St	101	4.5	15.9	0.1	29
	36	6.7	12.7	0.1	19
Loma Verde Wy	102	4.4	16.9	0.1	30
29th St	37	29.3	42.9	0.2	13
Serenity Dr	103	18.0	39.2	0.2	22
HS Dwy	155	1.2	2.7	0.0	23
Luther Burbank HS	39	4.4	10.3	0.1	23
	135	3.9	9.5	0.1	23
Luther Dr	40	22.5	27.6	0.1	8
Luther Dr	105	3.3	7.0	0.0	21
Munson Wy	41	4.3	17.3	0.1	30
	140	0.9	4.7	0.0	29
Franklin Bl	137	31.2	39.1	0.1	9
	138	2.4	7.6	0.0	23
Total		164.4	325.0	1.8	20

Arterial Level of Service: WB Florin Rd

Cross Street	Node	Delay (s/veh)	Travel time (s)	Dist (mi)	Arterial Speed
	138	14.1	44.6	0.4	29
Franklin Bl	137	34.8	39.2	0.0	5
	140	9.6	19.0	0.1	19
	41	3.8	7.2	0.0	19
Luther Dr	105	32.1	44.9	0.1	12
Luther Dr	40	3.9	7.7	0.0	20
	135	2.4	7.9	0.1	27
Hisperry Ln	39	2.2	7.5	0.1	29
HS Dwy	155	4.1	10.1	0.1	24
Serenity Dr	103	4.6	6.1	0.0	10
Indian Ln	37	8.1	29.4	0.2	30
Loma Verde Wy	102	2.5	16.5	0.2	34
Woodbine Av	36	5.2	17.6	0.1	29
	101	2.0	8.3	0.1	29
24th St	35	27.6	38.7	0.1	12
Total		157.1	304.8	1.7	20

SimTraffic Post-Processor
Average Results from 10 Runs
Volume and Delay by Movement

Vision Zero Top 5 Corridors - Florin Rd
VZ Top 5 Recommendations
AM Peak Hour

Intersection 35 **24th St/Florin Rd** **Signal**

Direction	Movement	Demand Volume (vph)	Served Volume (vph)		Total Delay (sec/veh)		
			Average	Percent	Average	Std. Dev.	LOS
NB	Left Turn	160	143	89.2%	59.1	18.5	E
	Through	497	497	100.0%	31.4	2.4	C
	Right Turn	22	23	104.2%	23.6	6.7	C
	Subtotal	679	662	97.6%	37.4	5.4	D
SB	Left Turn	122	122	100.0%	53.2	13.5	D
	Through	254	248	97.6%	26.4	1.7	C
	Right Turn	312	314	100.6%	11.7	2.2	B
	Subtotal	688	684	99.4%	24.7	3.2	C
EB	Left Turn	353	248	70.3%	172.0	38.5	F
	Through	615	590	96.0%	30.1	5.2	C
	Right Turn	69	70	100.8%	22.0	6.7	C
	Subtotal	1,037	908	87.6%	68.5	13.5	E
WB	Left Turn	75	68	91.2%	40.2	8.4	D
	Through	575	542	94.3%	31.8	2.9	C
	Right Turn	121	113	93.3%	16.2	2.6	B
	Subtotal	771	723	93.8%	30.2	2.3	C
Total		3,175	2,978	93.8%	42.2	3.6	D

Intersection 36 **Woodbine Av/Florin Rd** **Signal**

Direction	Movement	Demand Volume (vph)	Served Volume (vph)		Total Delay (sec/veh)		
			Average	Percent	Average	Std. Dev.	LOS
NB	Left Turn	1	0	36.4%	10.4	33.0	B
	Through	2	2	109.2%	42.3	40.5	D
	Right Turn						
	Subtotal	3	3	84.9%	52.8	41.8	D
SB	Left Turn	26	21	82.6%	43.5	11.8	D
	Through	1	1	145.6%	19.2	37.1	B
	Right Turn	31	31	101.0%	8.4	3.1	A
	Subtotal	58	54	93.5%	24.7	8.7	C
EB	Left Turn	48	52	108.4%	54.0	10.2	D
	Through	927	905	97.6%	5.6	1.1	A
	Right Turn	6	8	139.5%	4.7	2.0	A
	Subtotal	981	965	98.4%	8.3	1.5	A
WB	Left Turn	2	3	127.4%	38.2	27.0	D
	Through	929	862	92.8%	16.2	2.3	B
	Right Turn	23	20	87.0%	14.8	2.9	B
	Subtotal	954	885	92.8%	16.3	2.3	B
Total		1,996	1,907	95.5%	12.5	1.4	B

SimTraffic Post-Processor
Average Results from 10 Runs
Volume and Delay by Movement

Vision Zero Top 5 Corridors - Florin Rd
VZ Top 5 Recommendations
AM Peak Hour

Intersection 37 Indian Ln-29th St/Florin Rd Signal

Direction	Movement	Demand Volume (vph)	Served Volume (vph)		Total Delay (sec/veh)		
			Average	Percent	Average	Std. Dev.	LOS
NB	Left Turn	34	29	84.6%	32.5	12.6	C
	Through	9	11	117.3%	30.7	15.4	C
	Right Turn	291	281	96.7%	18.5	2.4	B
	Subtotal	334	321	96.0%	20.4	2.4	C
SB	Left Turn	79	87	109.7%	46.0	11.4	D
	Through	14	11	80.6%	39.6	19.8	D
	Right Turn	15	16	106.8%	7.9	6.6	A
	Subtotal	108	114	105.5%	39.9	7.8	D
EB	Left Turn	23	20	88.6%	46.4	20.0	D
	Through	913	898	98.3%	34.3	4.0	C
	Right Turn	33	29	87.1%	28.1	7.3	C
	Subtotal	969	947	97.7%	34.3	3.8	C
WB	Left Turn	152	140	92.2%	43.2	10.2	D
	Through	961	933	97.1%	24.7	2.5	C
	Right Turn	57	50	87.5%	9.2	1.2	A
	Subtotal	1,170	1,123	96.0%	26.3	1.9	C
Total		2,581	2,505	97.0%	29.2	2.3	C

Intersection 39 Hisperry Ln-Luther Burbank HS/Florin Rd Signal

Direction	Movement	Demand Volume (vph)	Served Volume (vph)		Total Delay (sec/veh)		
			Average	Percent	Average	Std. Dev.	LOS
NB	Left Turn	184	174	94.4%	35.2	4.1	D
	Through	1	1	109.2%	17.8	30.2	B
	Right Turn	89	85	95.7%	17.6	5.1	B
	Subtotal	274	260	94.9%	29.6	4.1	C
SB	Left Turn						
	Through						
	Right Turn						
	Subtotal						
EB	Left Turn						
	Through	991	950	95.9%	6.1	0.7	A
	Right Turn	8	9	118.3%	4.7	4.0	A
	Subtotal	999	960	96.1%	6.0	0.7	A
WB	Left Turn	148	146	98.4%	41.9	5.2	D
	Through	976	940	96.3%	10.4	1.5	B
	Right Turn	3	2	72.8%	6.8	4.2	A
	Subtotal	1,127	1,088	96.5%	14.7	1.9	B
Total		2,400	2,308	96.2%	12.8	1.4	B

SimTraffic Post-Processor
Average Results from 10 Runs
Volume and Delay by Movement

Vision Zero Top 5 Corridors - Florin Rd
VZ Top 5 Recommendations
AM Peak Hour

Intersection 40 **Luther Dr/Florin Rd** **Signal**

Direction	Movement	Demand Volume (vph)	Served Volume (vph)		Total Delay (sec/veh)		
			Average	Percent	Average	Std. Dev.	LOS
NB	Left Turn	130	127	98.0%	39.2	5.2	D
	Through	48	47	97.8%	40.8	5.0	D
	Right Turn	170	174	102.6%	16.4	4.3	B
	Subtotal	348	349	100.2%	28.1	4.1	C
SB	Left Turn	64	62	96.3%	36.7	6.2	D
	Through	44	42	96.6%	36.4	6.2	D
	Right Turn	191	204	106.7%	14.0	3.1	B
	Subtotal	299	308	103.0%	21.7	3.6	C
EB	Left Turn	198	171	86.6%	77.7	14.4	E
	Through	842	803	95.4%	83.8	14.8	F
	Right Turn	59	51	87.1%	83.5	14.7	F
	Subtotal	1,099	1,026	93.3%	82.7	14.7	F
WB	Left Turn	101	96	94.8%	78.6	16.6	E
	Through	758	718	94.7%	45.6	9.2	D
	Right Turn	28	28	100.1%	47.2	10.0	D
	Subtotal	887	842	94.9%	49.5	10.4	D
Total		2,633	2,524	95.9%	56.6	7.6	E

Intersection 41 **Munson Wy/Florin Rd** **Signal**

Direction	Movement	Demand Volume (vph)	Served Volume (vph)		Total Delay (sec/veh)		
			Average	Percent	Average	Std. Dev.	LOS
NB	Left Turn						
	Through						
	Right Turn	106	108	102.3%	13.0	3.6	B
	Subtotal	106	108	102.3%	13.0	3.6	B
SB	Left Turn						
	Through						
	Right Turn	10	0	0.0%	0.0	0.0	A
	Subtotal	10	0	0.0%	0.0	0.0	A
EB	Left Turn	7	6	88.4%	4.7	4.1	A
	Through	1,067	1,032	96.7%	2.9	0.3	A
	Right Turn	47	40	85.2%	3.3	0.9	A
	Subtotal	1,121	1,078	96.1%	2.9	0.3	A
WB	Left Turn	59	62	104.9%	11.7	3.7	B
	Through	922	928	100.7%	0.7	0.2	A
	Right Turn	19	9	47.9%	0.0	0.1	A
	Subtotal	1,000	999	99.9%	1.3	0.3	A
Total		2,237	2,185	97.7%	2.7	0.4	A

SimTraffic Post-Processor
Average Results from 10 Runs
Volume and Delay by Movement

Vision Zero Top 5 Corridors - Florin Rd
VZ Top 5 Recommendations
AM Peak Hour

Intersection 102 Loma Verde Wy/Florin Rd Signal

Direction	Movement	Demand Volume (vph)	Served Volume (vph)		Total Delay (sec/veh)		
			Average	Percent	Average	Std. Dev.	LOS
NB	Left Turn	40	36	90.1%	47.6	10.7	D
	Through						
	Right Turn	66	68	102.6%	21.7	6.0	C
	Subtotal	106	104	97.9%	30.6	6.2	C
SB	Left Turn						
	Through						
	Right Turn						
	Subtotal						
EB	Left Turn						
	Through	903	877	97.1%	6.2	1.2	A
	Right Turn	50	53	105.6%	4.4	1.0	A
	Subtotal	953	930	97.6%	6.1	1.2	A
WB	Left Turn	96	85	88.3%	56.6	7.4	E
	Through	914	878	96.0%	11.2	1.8	B
	Right Turn						
	Subtotal	1,010	962	95.3%	15.2	2.0	B
Total		2,069	1,996	96.5%	11.8	1.1	B

Intersection 103 Serenity Dr/Florin Rd Signal

Direction	Movement	Demand Volume (vph)	Served Volume (vph)		Total Delay (sec/veh)		
			Average	Percent	Average	Std. Dev.	LOS
NB	Left Turn						
	Through						
	Right Turn						
	Subtotal						
SB	Left Turn						
	Through						
	Right Turn	28	32	115.7%	30.6	8.1	C
	Subtotal	28	32	115.7%	30.6	8.1	C
EB	Left Turn	18	19	107.2%	66.9	12.0	E
	Through	1,265	954	75.4%	15.6	1.1	B
	Right Turn						
	Subtotal	1,283	973	75.8%	16.7	1.4	B
WB	Left Turn						
	Through	1,142	1,094	95.8%	18.3	1.1	B
	Right Turn	18	17	93.0%	14.4	4.1	B
	Subtotal	1,160	1,111	95.8%	18.3	1.1	B
Total		2,471	2,116	85.6%	17.7	1.1	B

SimTraffic Post-Processor
Average Results from 10 Runs
Volume and Delay by Movement

Vision Zero Top 5 Corridors - Florin Rd
VZ Top 5 Recommendations
PM Peak Hour

Intersection 35 24th St/Florin Rd Signal

Direction	Movement	Demand Volume (vph)	Served Volume (vph)		Total Delay (sec/veh)		
			Average	Percent	Average	Std. Dev.	LOS
NB	Left Turn	131	133	101.2%	42.8	7.5	D
	Through	299	304	101.8%	29.2	2.4	C
	Right Turn	49	46	93.1%	24.5	5.2	C
	Subtotal	479	483	100.8%	32.8	2.0	C
SB	Left Turn	171	162	94.7%	47.8	4.3	D
	Through	487	490	100.7%	30.3	3.3	C
	Right Turn	400	396	99.0%	15.9	3.9	B
	Subtotal	1,058	1,048	99.1%	27.6	2.2	C
EB	Left Turn	241	229	95.1%	56.7	17.1	E
	Through	652	636	97.5%	27.3	2.6	C
	Right Turn	89	100	112.3%	22.7	3.7	C
	Subtotal	982	965	98.3%	34.1	5.9	C
WB	Left Turn	112	108	96.4%	51.1	8.1	D
	Through	719	651	90.6%	31.5	3.0	C
	Right Turn	139	124	89.4%	16.5	1.8	B
	Subtotal	970	884	91.1%	31.8	1.9	C
Total		3,489	3,379	96.8%	31.3	2.1	C

Intersection 36 Woodbine Av/Florin Rd Signal

Direction	Movement	Demand Volume (vph)	Served Volume (vph)		Total Delay (sec/veh)		
			Average	Percent	Average	Std. Dev.	LOS
NB	Left Turn	2	2	76.0%	21.8	34.9	C
	Through						
	Right Turn	1	1	114.0%	3.2	6.0	A
	Subtotal	3	3	88.7%	19.7	23.1	B
SB	Left Turn	36	29	81.3%	49.2	10.2	D
	Through						
	Right Turn	34	38	112.9%	12.1	3.4	B
	Subtotal	70	68	96.6%	28.4	6.4	C
EB	Left Turn	54	48	88.7%	57.9	14.8	E
	Through	966	930	96.3%	10.0	1.7	B
	Right Turn	2	3	152.0%	6.1	5.4	A
	Subtotal	1,022	981	96.0%	12.3	1.7	B
WB	Left Turn	5	3	60.8%	32.3	29.0	C
	Through	1,085	1,032	95.2%	5.1	1.9	A
	Right Turn	31	24	76.0%	2.7	1.7	A
	Subtotal	1,121	1,059	94.5%	5.2	1.8	A
Total		2,216	2,110	95.2%	9.3	1.5	A

SimTraffic Post-Processor
Average Results from 10 Runs
Volume and Delay by Movement

Vision Zero Top 5 Corridors - Florin Rd
VZ Top 5 Recommendations
PM Peak Hour

Intersection 37 Indian Ln-29th St/Florin Rd Signal

Direction	Movement	Demand Volume (vph)	Served Volume (vph)		Total Delay (sec/veh)		
			Average	Percent	Average	Std. Dev.	LOS
NB	Left Turn	54	49	90.8%	34.1	5.8	C
	Through	19	19	100.0%	42.2	11.9	D
	Right Turn	146	147	101.0%	11.8	2.3	B
	Subtotal	219	215	98.4%	19.5	2.7	B
SB	Left Turn	70	63	90.7%	43.0	12.7	D
	Through	11	10	86.4%	36.3	21.7	D
	Right Turn	32	32	99.8%	11.1	5.8	B
	Subtotal	113	105	92.8%	33.1	10.2	C
EB	Left Turn	37	31	83.2%	48.4	19.5	D
	Through	961	896	93.2%	29.0	3.2	C
	Right Turn	33	29	86.4%	26.4	6.9	C
	Subtotal	1,031	955	92.6%	29.5	3.0	C
WB	Left Turn	190	183	96.4%	56.4	12.7	E
	Through	1,094	1,037	94.8%	8.4	2.1	A
	Right Turn	79	76	95.7%	4.6	1.7	A
	Subtotal	1,363	1,295	95.0%	15.1	2.5	B
Total		2,726	2,571	94.3%	21.6	1.8	C

Intersection 39 Hisperry Ln-Luther Burbank HS/Florin Rd Signal

Direction	Movement	Demand Volume (vph)	Served Volume (vph)		Total Delay (sec/veh)		
			Average	Percent	Average	Std. Dev.	LOS
NB	Left Turn	15	13	83.6%	46.6	16.0	D
	Through						
	Right Turn	11	9	79.5%	8.4	6.4	A
	Subtotal	26	21	81.8%	32.2	12.9	C
SB	Left Turn						
	Through						
	Right Turn	2	0	19.0%	2.7	6.0	A
	Subtotal	2	0	19.0%	1.7	5.5	A
EB	Left Turn						
	Through	1,135	1,068	94.1%	4.4	1.3	A
	Right Turn	2	2	76.0%	1.6	4.7	A
	Subtotal	1,137	1,070	94.1%	4.3	1.3	A
WB	Left Turn	12	10	85.5%	62.1	24.6	E
	Through	1,354	1,301	96.1%	6.1	2.3	A
	Right Turn	8	7	85.5%	4.7	2.0	A
	Subtotal	1,374	1,318	95.9%	6.6	2.3	A
Total		2,539	2,410	94.9%	5.8	1.8	A

SimTraffic Post-Processor
Average Results from 10 Runs
Volume and Delay by Movement

Vision Zero Top 5 Corridors - Florin Rd
VZ Top 5 Recommendations
PM Peak Hour

Intersection 40 **Luther Dr/Florin Rd** **Signal**

Direction	Movement	Demand Volume (vph)	Served Volume (vph)		Total Delay (sec/veh)		
			Average	Percent	Average	Std. Dev.	LOS
NB	Left Turn	105	107	101.5%	36.8	2.6	D
	Through	5	5	95.0%	34.8	3.2	C
	Right Turn	48	46	95.8%	11.5	2.4	B
	Subtotal	158	157	99.6%	29.4	2.0	C
SB	Left Turn	83	85	102.4%	37.2	4.1	D
	Through	8	8	96.2%	37.2	4.8	D
	Right Turn	184	184	100.2%	17.0	2.6	B
	Subtotal	275	277	100.7%	23.8	2.5	C
EB	Left Turn	127	112	88.3%	61.6	13.7	E
	Through	929	866	93.2%	67.3	13.9	E
	Right Turn	84	71	84.9%	67.3	14.4	E
	Subtotal	1,140	1,049	92.0%	66.7	13.9	E
WB	Left Turn	57	56	101.6%	69.1	15.4	E
	Through	1,080	1,036	95.9%	36.7	5.8	D
	Right Turn	48	44	90.6%	34.6	5.6	C
	Subtotal	1,185	1,135	95.8%	38.2	6.1	D
Total		2,758	2,619	94.9%	47.8	7.1	D

Intersection 41 **Munson Wy/Florin Rd** **Signal**

Direction	Movement	Demand Volume (vph)	Served Volume (vph)		Total Delay (sec/veh)		
			Average	Percent	Average	Std. Dev.	LOS
NB	Left Turn						
	Through						
	Right Turn	42	33	78.7%	8.8	3.1	A
Subtotal		42	33	78.7%	8.8	3.1	A
SB	Left Turn	1	0	0.0%	#DIV/0!	#DIV/0!	#DIV/0!
	Through						
	Right Turn	5	5	98.8%	8.9	8.2	A
Subtotal		6	5	82.3%	8.9	8.2	A
EB	Left Turn	9	10	109.8%	30.1	17.7	C
	Through	1,006	936	93.0%	4.2	1.3	A
	Right Turn	66	67	101.9%	3.9	0.9	A
	Subtotal	1,081	1,013	93.7%	4.5	1.1	A
WB	Left Turn	169	158	93.8%	58.3	21.3	E
	Through	1,176	1,159	98.6%	3.8	1.6	A
	Right Turn	9	9	97.1%	2.0	4.7	A
	Subtotal	1,354	1,327	98.0%	10.7	5.0	B
Total		2,483	2,378	95.8%	8.0	2.7	A

SimTraffic Post-Processor
Average Results from 10 Runs
Volume and Delay by Movement

Vision Zero Top 5 Corridors - Florin Rd
VZ Top 5 Recommendations
PM Peak Hour

Intersection 102 Loma Verde Wy/Florin Rd Signal

Direction	Movement	Demand Volume (vph)	Served Volume (vph)		Total Delay (sec/veh)		
			Average	Percent	Average	Std. Dev.	LOS
NB	Left Turn						
	Through						
	Right Turn	28	25	89.6%	8.0	3.2	A
	Subtotal	28	25	89.6%	8.0	3.2	A
SB	Left Turn						
	Through						
	Right Turn						
	Subtotal						
EB	Left Turn						
	Through	1,003	960	95.7%	4.3	1.0	A
	Right Turn						
	Subtotal	1,003	960	95.7%	4.3	1.0	A
WB	Left Turn	59	50	84.4%	47.0	7.4	D
	Through	1,121	1,058	94.4%	2.4	0.4	A
	Right Turn						
	Subtotal	1,180	1,108	93.9%	4.5	0.8	A
Total		2,211	2,093	94.6%	4.5	0.7	A

Intersection 103 Serenity Dr/Florin Rd Signal

Direction	Movement	Demand Volume (vph)	Served Volume (vph)		Total Delay (sec/veh)		
			Average	Percent	Average	Std. Dev.	LOS
NB	Left Turn						
	Through						
	Right Turn						
	Subtotal						
SB	Left Turn						
	Through						
	Right Turn	17	17	98.4%	32.7	18.1	C
	Subtotal	17	17	98.4%	32.7	18.1	C
EB	Left Turn	25	28	111.0%	58.7	20.2	E
	Through	1,152	1,094	95.0%	16.0	3.7	B
	Right Turn						
	Subtotal	1,177	1,122	95.3%	17.0	3.7	B
WB	Left Turn						
	Through	1,346	1,289	95.8%	8.7	3.0	A
	Right Turn	25	26	103.4%	8.8	5.4	A
	Subtotal	1,371	1,315	95.9%	8.7	3.0	A
Total		2,565	2,454	95.7%	12.7	2.8	B

Queuing and Blocking Report
 Vision Zero Top 5 Recommendations

AM Peak Hour
 Vision Zero - Top 5 Corridors

Intersection: 103: Florin Rd & Serenity Dr

Movement	EB	EB	EB	WB	WB	SB
Directions Served	L	T	T	T	TR	R
Maximum Queue (ft)	85	236	270	115	116	65
Average Queue (ft)	32	118	141	101	98	27
95th Queue (ft)	93	242	277	148	149	73
Link Distance (ft)		1225	1225	36	36	383
Upstream Blk Time (%)				28	27	
Queuing Penalty (veh)				179	172	
Storage Bay Dist (ft)	130					
Storage Blk Time (%)	0	4				
Queuing Penalty (veh)	0	1				

Queuing and Blocking Report
 Vision Zero Top 5 Recommendations

PM Peak Hour
 Vision Zero - Top 5 Corridors

Intersection: 103: Florin Rd & Serenity Dr

Movement	EB	EB	EB	WB	WB	SB
Directions Served	L	T	T	T	TR	R
Maximum Queue (ft)	76	343	356	110	117	36
Average Queue (ft)	29	169	169	78	82	17
95th Queue (ft)	76	386	382	139	146	47
Link Distance (ft)		1225	1225	36	36	383
Upstream Blk Time (%)				21	24	
Queuing Penalty (veh)				153	170	
Storage Bay Dist (ft)	130					
Storage Blk Time (%)		10				
Queuing Penalty (veh)		3				



Major Street Florin Rd
 Minor Street Munson Wy

Project Vision Zero Top 5 Corridors
 Scenario Existing Conditions
 Peak Hour AM Peak Hour

Turn Movement Volumes

	NB	SB	EB	WB
Left	0	0	7	59
Through	0	0	1,067	932
Right	106	0	47	9
Total	106	0	1,121	1,000

Major Street Direction

	North/South
x	East/West

Intersection Geometry

Number of Approach Lanes for Minor Street	1
Total Approaches	3

Worst Case Delay for Minor Street

Stopped Delay (seconds per vehicle)	10.4
Approach with Worst Case Delay	NB
Total Vehicles on Approach	106

Warrant 3A, Peak Hour			
	Peak Hour Delay on Minor Approach (vehicle-hours)	Peak Hour Volume on Minor Approach (vph)	Peak Hour Entering Volume Served (vph)
Existing Conditions	0.3	106	2,227
Limiting Value	4	100	800
Condition Satisfied?	Not Met	Met	Met
Warrant Met	<u>NO</u>		

Major Street **Florin Rd**
 Minor Street **Munson Wy**

Project **Vision Zero Top 5 Corridors**
 Scenario **Existing Conditions**
 Peak Hour **AM Peak Hour**

Turn Movement Volumes

	NB	SB	EB	WB
Left	0	0	7	59
Through	0	0	1,067	932
Right	106	0	47	9
Total	106	0	1,121	1,000

Major Street Direction

	North/South
x	East/West

Figure 4C-4. Warrant 3B, Peak Hour (70% Factor)
 (COMMUNITY LESS THAN 10,000 POPULATION OR

ABOVE 40 MPH ON MAJOR STREET

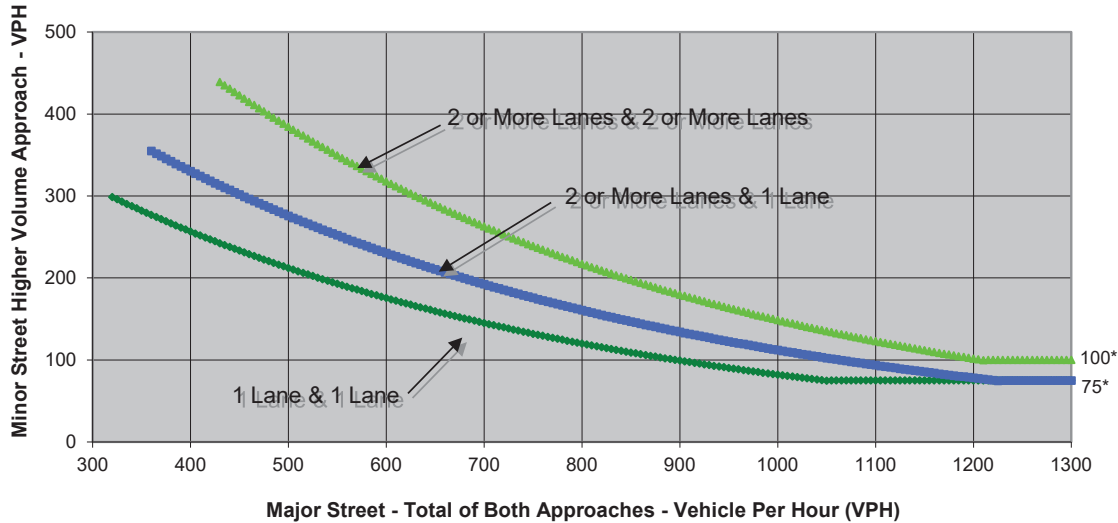

* Note: 100 vph applies as the lower threshold volume for a minor-street approach with two or more lanes and 75 vph applies as the lower threshold volume for a minor-street approach with one lane.

Source: California Manual on Uniform Traffic Control Devices, Caltrans, 2014

	Major Street	Minor Street	Warrant Met
	Florin Rd	Munson Wy	
Number of Approach Lanes	1	1	YES
Traffic Volume (VPH) *	2,121	106	
* Note: Traffic Volume for Major Street is Total Volume of Both Approaches. Traffic Volume for Minor Street is the Volume of High Volume Approach.			



Major Street Florin Rd
 Minor Street Munson Wy

Project Vision Zero Top 5 Corridors
 Scenario Existing Conditions
 Peak Hour PM Peak Hour

Turn Movement Volumes

	NB	SB	EB	WB
Left	0	0	9	169
Through	0	0	1,006	1,176
Right	42	6	66	9
Total	42	6	1,081	1,354

Major Street Direction

	North/South
x	East/West

Intersection Geometry

Number of Approach Lanes for Minor Street	1
Total Approaches	4

Worst Case Delay for Minor Street

Stopped Delay (seconds per vehicle)	7.7
Approach with Worst Case Delay	SB
Total Vehicles on Approach	6

Warrant 3A, Peak Hour			
	Peak Hour Delay on Minor Approach (vehicle-hours)	Peak Hour Volume on Minor Approach (vph)	Peak Hour Entering Volume Serviced (vph)
Existing Conditions	0	42	2,483
Limiting Value	4	100	800
Condition Satisfied?	Not Met	Not Met	Met
Warrant Met	<u>NO</u>		

Major Street **Florin Rd**
 Minor Street **Munson Wy**

Project **Vision Zero Top 5 Corridors**
 Scenario **Existing Conditions**
 Peak Hour **PM Peak Hour**

Turn Movement Volumes

	NB	SB	EB	WB
Left	0	0	9	169
Through	0	0	1,006	1,176
Right	42	6	66	9
Total	42	6	1,081	1,354

Major Street Direction

	North/South
x	East/West

Figure 4C-4. Warrant 3B, Peak Hour (70% Factor)
 (COMMUNITY LESS THAN 10,000 POPULATION OR

ABOVE 40 MPH ON MAJOR STREET

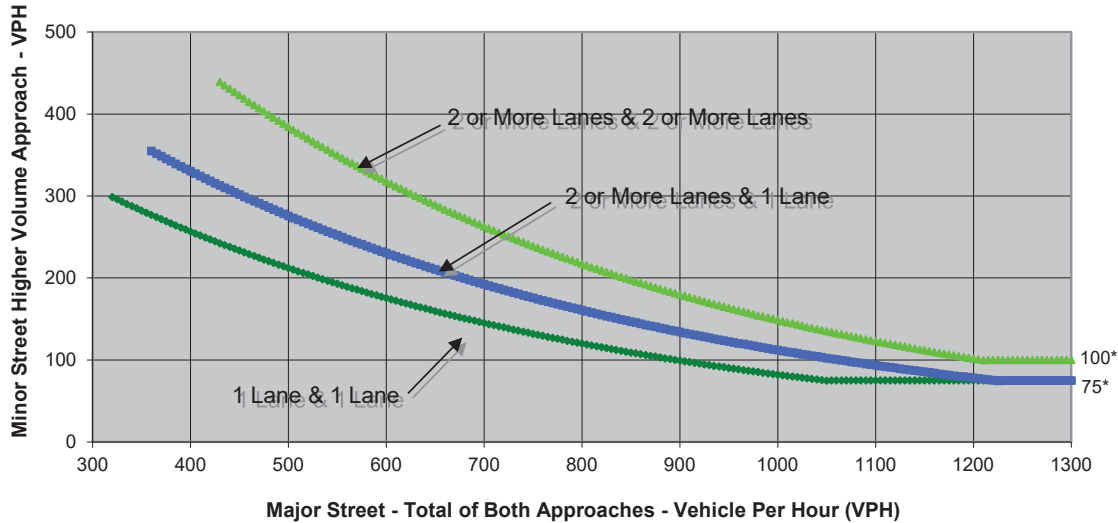

* Note: 100 vph applies as the lower threshold volume for a minor-street approach with two or more lanes and 75 vph applies as the lower threshold volume for a minor-street approach with one lane.

Source: California Manual on Uniform Traffic Control Devices, Caltrans, 2014





	Major Street	Minor Street	Warrant Met
	Florin Rd	Munson Wy	
Number of Approach Lanes	1	1	NO
Traffic Volume (VPH) *	2,435	42	
* Note: Traffic Volume for Major Street is Total Volume of Both Approaches. Traffic Volume for Minor Street is the Volume of High Volume Approach.			

Appendix C

Concept Plans & Cost Estimates

El Camino Avenue

LEGEND:

-  BUS STOP LOCATION
-  NEW SIGNAL
-  EXISTING SIGNAL
-  NEW PEDESTRIAN SIGNAL
-  LANDSCAPE AREA
-  OBLITERATE SURFACE
-  ROADWAY WIDENING AREA

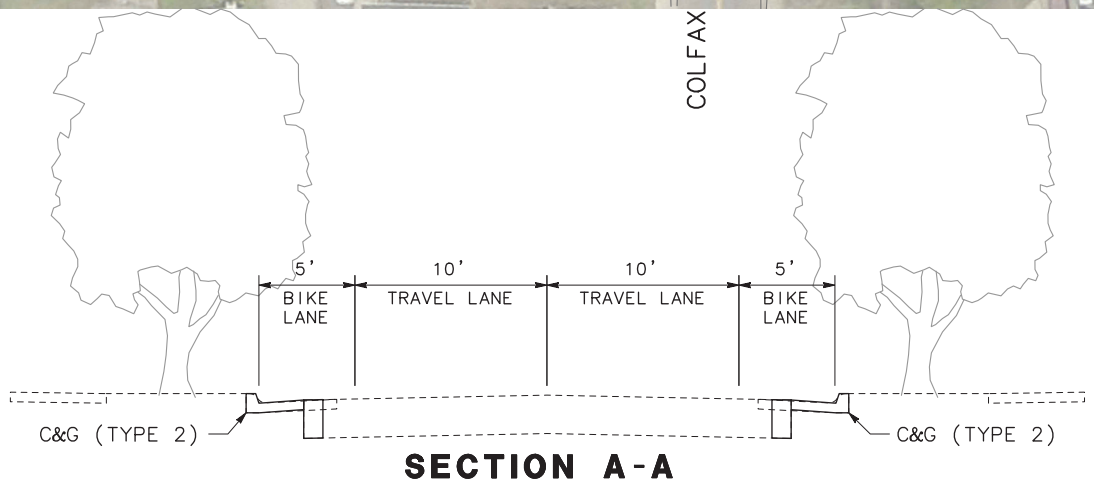
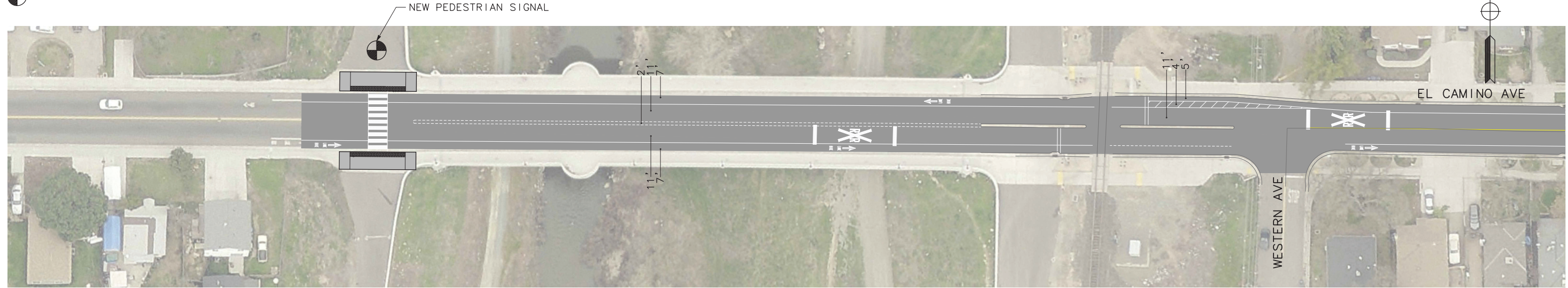

VISION ZERO - TOP 5 EL CAMINO AVE	
CITY OF SACRAMENTO	 MARK THOMAS

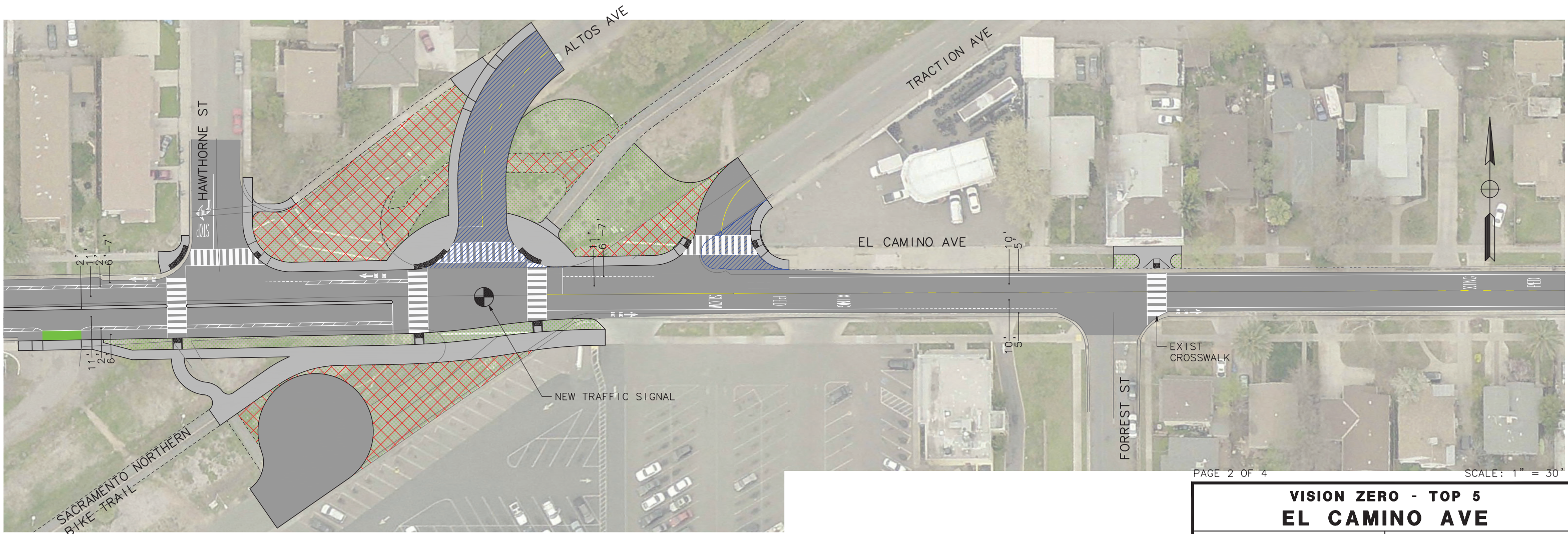

VISION ZERO - TOP 5 EL CAMINO AVE	
CITY OF SACRAMENTO	MARK THOMAS

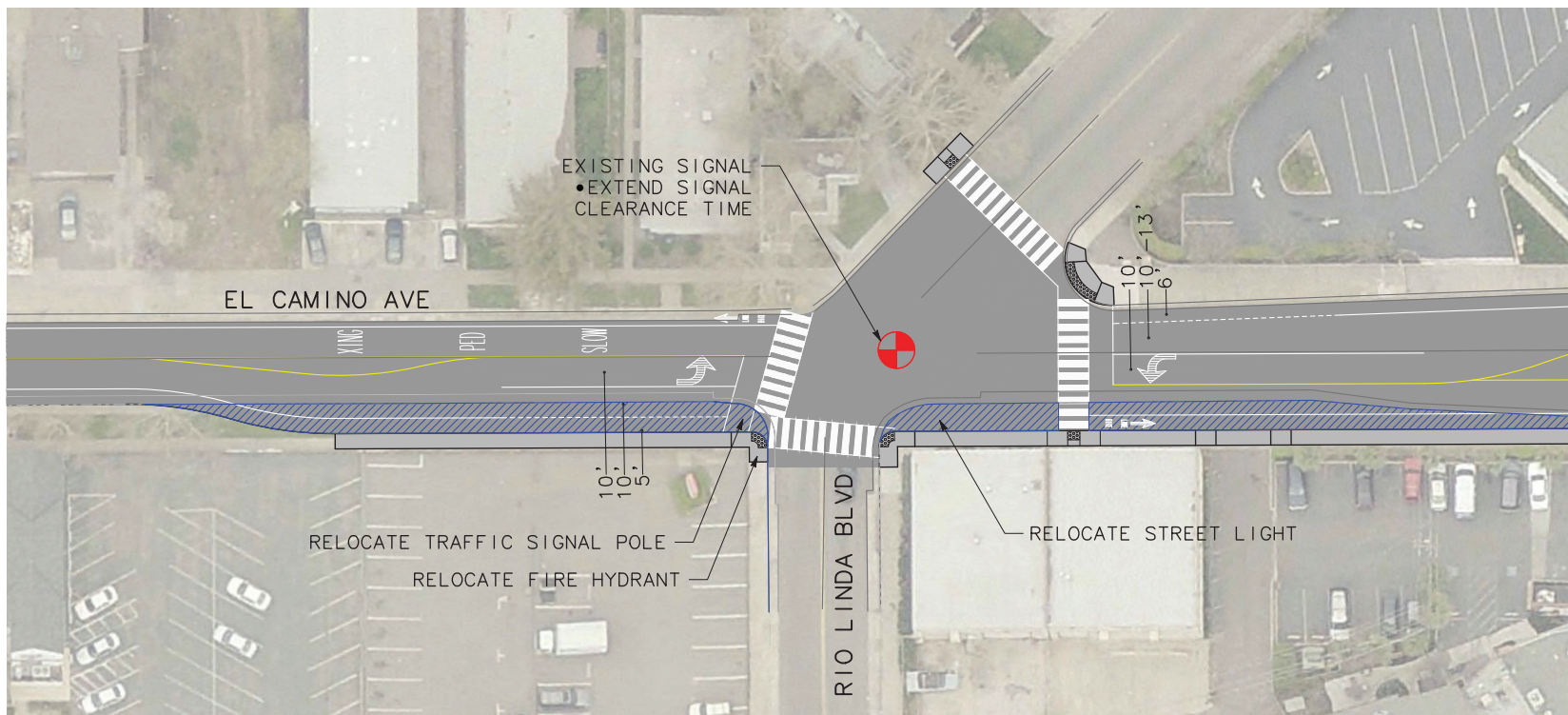

VISION ZERO - TOP 5 EL CAMINO AVE	
CITY OF SACRAMENTO	 MARK THOMAS



VISION ZERO - TOP 5	
EL CAMINO AVE	
CITY OF SACRAMENTO	MARK THOMAS

El Camino Avenue

(Feasibility Opinion of Probable Cost)



SUMMARY OF PROJECT COST ESTIMATE

		Current Year Cost	Escalated Cost (2025)**
TOTAL CONSTRUCTION COST		\$ 8,947,809	\$ 10,372,963
TOTAL RIGHT OF WAY COST		\$ 400,000	\$ 463,710
TOTAL CAPITAL OUTLAY COSTS		\$ 9,348,000	\$ 10,837,000
DESIGN	PA/ED (12.5%)*	\$ 1,170,000	\$ 1,360,000
	PS&E (17.5%)	\$ 1,640,000	\$ 1,910,000
	RIGHT OF WAY (2%)	\$ 190,000	\$ 230,000
CM	CONSTRUCTION (19%)	\$ 1,780,000	\$ 2,070,000
TOTAL DELIVERY COST		\$ 4,780,000	\$ 5,570,000
TOTAL PROJECT COST		\$ 14,150,000	\$ 16,450,000

* Support cost percentages reference the Multi-Agency CIP Benchmarking Study (2019) for streets projects

** Assumes escalation of 3% per year. No Adjustments in escalation for time between design and construction were made.

El Camino Avenue
(Feasibility Opinion of Probable Cost)



ITEM No.	ITEM DESCRIPTION	UNIT	QUANTITY	UNIT PRICE	TOTAL
ROADWAY					
1	Install Concrete - Curb Ramp	EA	36	\$8,000	\$288,000
2	Install Concrete - Curb	LF	2243	\$30	\$67,290
3	Install Concrete - Curb & Gutter	LF	6635	\$50	\$331,750
4	Install Concrete - Sidewalk	SF	27491	\$12	\$329,892
5	Install Concrete - Textured Paving	SF	5099	\$25	\$127,475
6	Roadway Excavation	CY	5311	\$80	\$424,880
7	Roadway Widening****	LS	1	\$156,861	\$156,861
8	Pavement Maintenance (includes overlay cost and base repair)	SY	28489	\$19	\$541,291
9	Obliterate Surface	SY	1388	\$90	\$124,920
10	Signing and Striping	LS	1	\$31,970	\$31,970
11	Green MMA (Methyl Methacrylate)	SF	1538	\$10	\$15,380
12	Landscape	SF	21563	\$8	\$172,504
13	Relocate Street Light	EA	1	\$25,000	\$25,000
14	Relocate Fire Hydrant	EA	1	\$8,000	\$8,000
ELECTRICAL					
15	New Traffic Signal (electrical cost only, civil and signal interconnect costs are accounted for seperatly)	EA	3	\$450,000	\$1,350,000
16	New Pedestrian Signal	EA	1	\$300,000	\$300,000
17	Signal Modification	EA	4	\$250,000	\$1,000,000
18	Traffic Signal Interconnect and ITS elements	LF	4456	\$41	\$182,696
19	Pedestrian Scale Lighting	EA	140	\$1,500	\$210,000
SUBTOTAL					\$5,687,909
20	Minor Items (10% of Items 1-18) **	LS	1	\$569,000	\$569,000
SUBTOTAL					\$6,256,909
21	Mobilization (10% of Items 1-19)	LS	1	\$626,000	\$626,000
SUBTOTAL					\$6,882,909
CONTINGENCY (30%) ***					\$2,064,900
CONSTRUCTION SUBTOTAL					\$8,947,809
GRAND TOTAL					
CONSTRUCTION SUBTOTAL =					\$8,947,809
Right of Way/Temporary Construction Easement* =					\$400,000
GRAND TOTAL =					\$9,347,809

* Right of way/TCE's for driveway closures, curb ramps, new signal equipment, conforms, etc. have been estimated at \$10K/Location.

** Minor items (for example, fencing, signage, sidewalk repair, utility adjustments, etc.) have been estimated by using a percentage.

*** This feasibility level estimate includes a 30% contingency intended to compensate for the use of limited information.

**** Areas of widening include new pavement structural section (0.50' HMA/1.50' CL2AB)

General Note Where applicable, only minor drainage improvements for transportation projects to address safety are included. Utility improvements such as water, communication, gas, etc. are not included in these estimates.

Marysville Boulevard

LEGEND:

- Ⓟ BUS STOP LOCATION
- ⦿ NEW SIGNAL
- ⦿ EXISTING SIGNAL
- DELINEATOR (TYPE K-71)
- ROADWAY WIDENING AREA

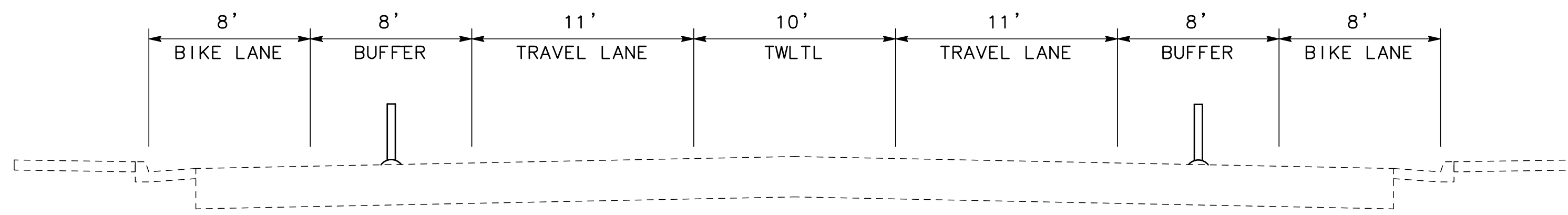
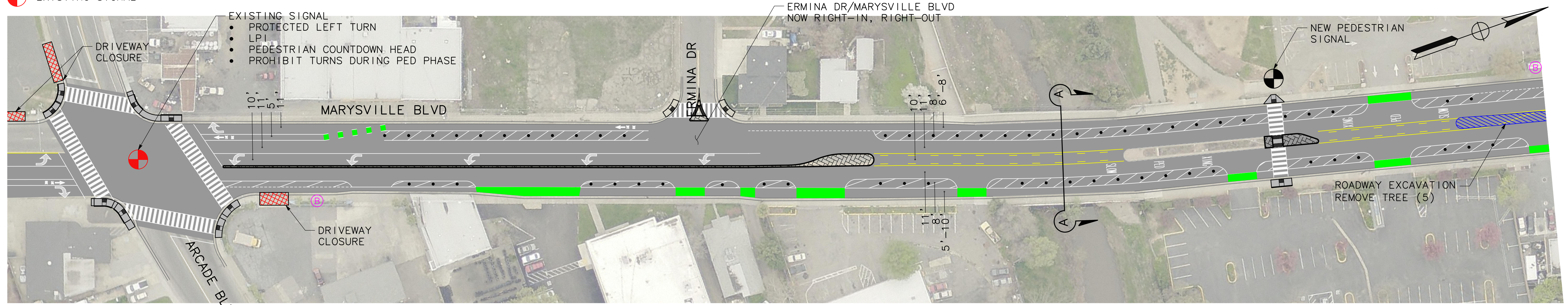

**SECTION A-A
(PROPOSED)**

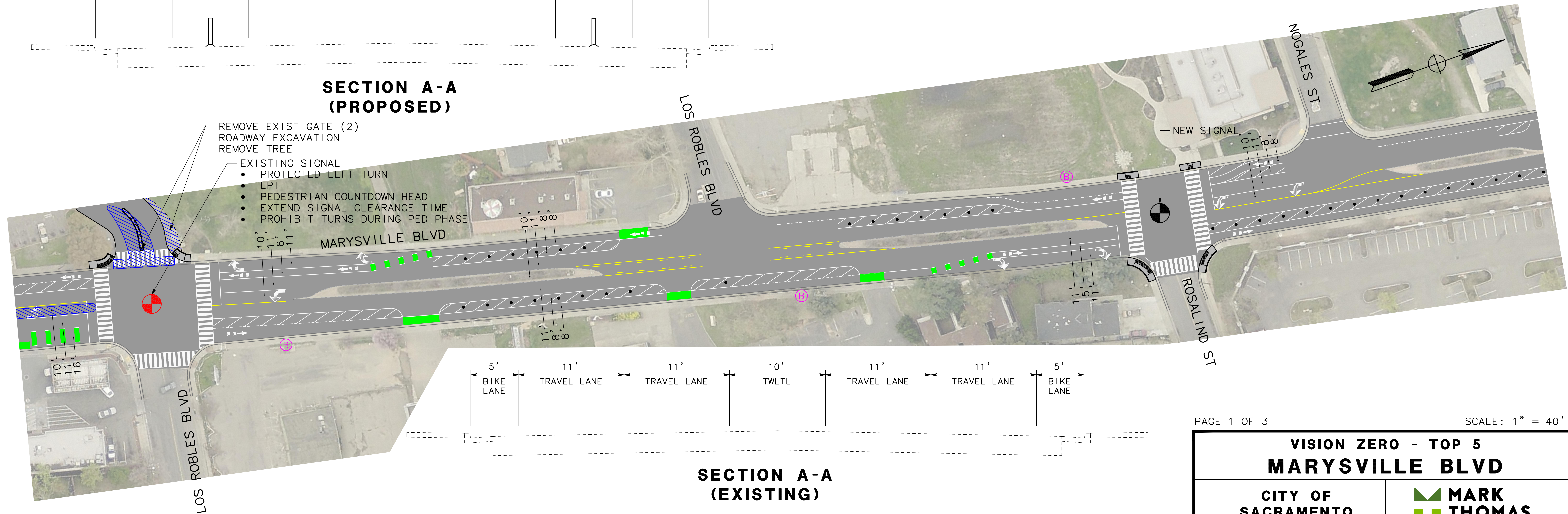

**SECTION A-A
(EXISTING)**

**VISION ZERO - TOP 5
MARYSVILLE BLVD**

**CITY OF
SACRAMENTO**

**MARK
THOMAS**

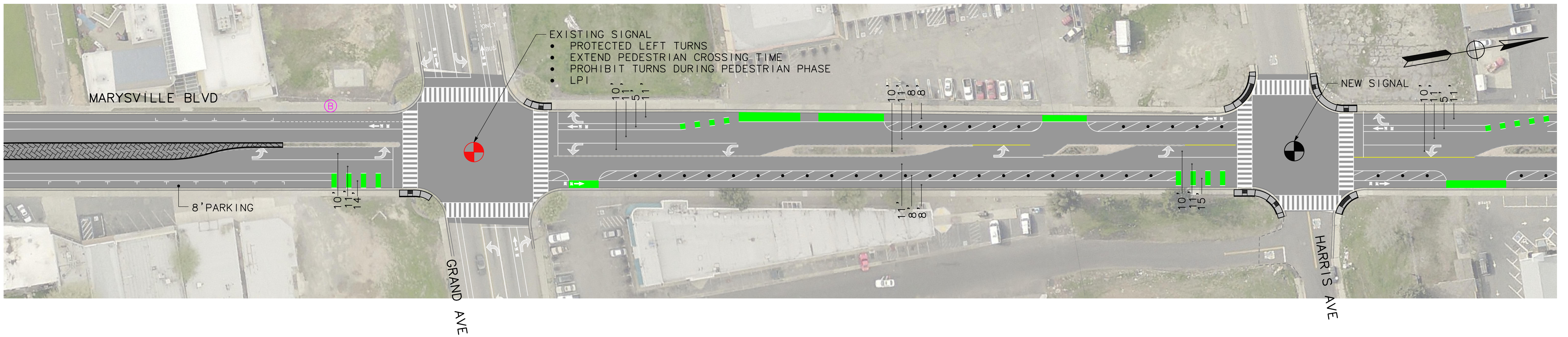
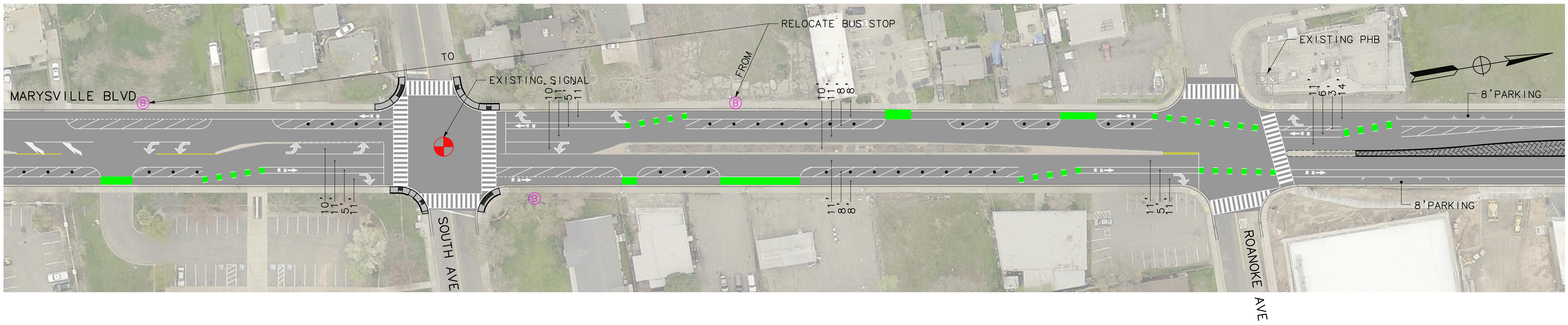

**VISION ZERO - TOP 5
MARYSVILLE BLVD**

**CITY OF
SACRAMENTO**

**MARK
THOMAS**

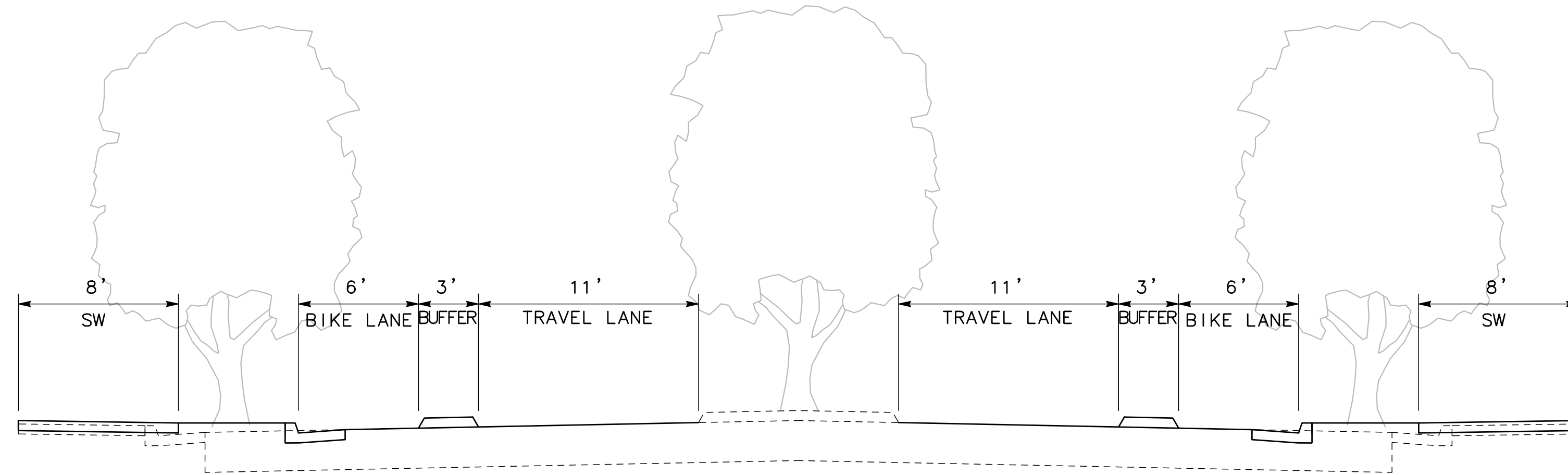
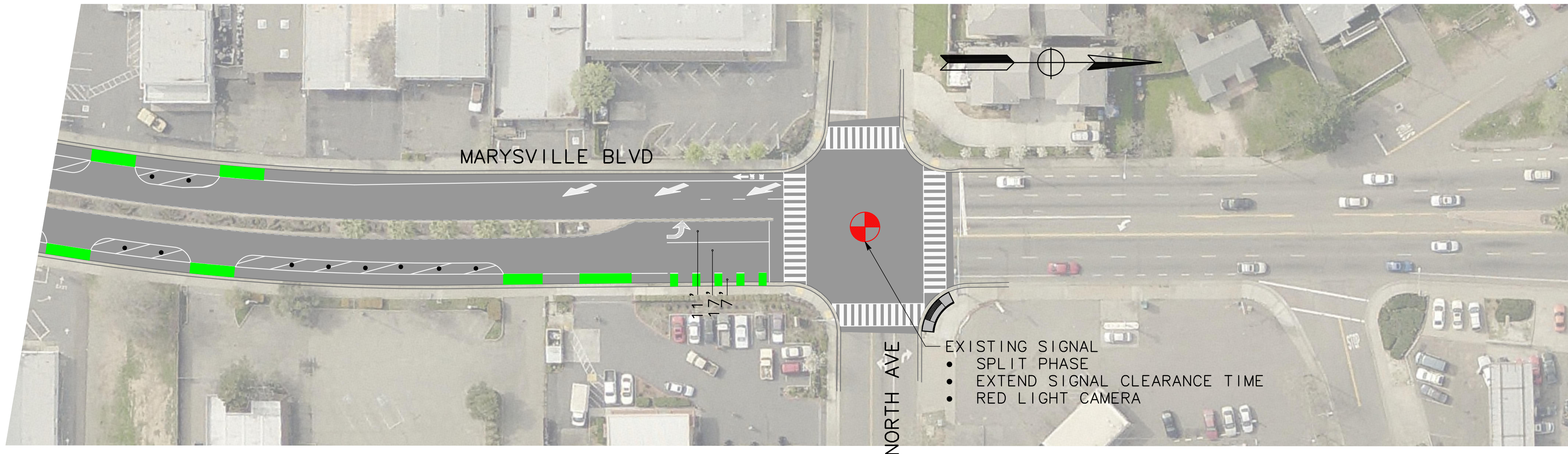

**SECTION A-A
(ULTIMATE)**

Marysville Boulevard

(Feasibility Opinion of Probable Cost)



MARK THOMAS

SUMMARY OF PROJECT COST ESTIMATE

		Current Year Cost	Escalated Cost (2025)**
TOTAL CONSTRUCTION COST		\$ 6,937,574	\$ 8,042,549
TOTAL RIGHT OF WAY COST		\$ 370,000	\$ 428,931
TOTAL CAPITAL OUTLAY COSTS		\$ 7,308,000	\$ 8,472,000
DESIGN	PA/ED (12.5%)*	\$ 920,000	\$ 1,070,000
	PS&E (17.5%)	\$ 1,280,000	\$ 1,490,000
	RIGHT OF WAY (2%)	\$ 150,000	\$ 180,000
CM	CONSTRUCTION (19%)	\$ 1,390,000	\$ 1,620,000
TOTAL DELIVERY COST		\$ 3,740,000	\$ 4,360,000
TOTAL PROJECT COST		\$ 11,050,000	\$ 12,850,000

* Support cost percentages reference the Multi-Agency CIP Benchmarking Study (2019) for streets projects

** Assumes escalation of 3% per year. No Adjustments in escalation for time between design and construction were made.

Marysville Boulevard

(Feasibility Opinion of Probable Cost)



ITEM No.	ITEM DESCRIPTION	UNIT	QUANTITY	UNIT PRICE	TOTAL
ROADWAY					
1	Install Concrete - Curb Ramp	EA	37	\$8,000	\$296,000
2	Install Concrete - Curb	LF	1634	\$30	\$49,016
3	Install Concrete - Curb & Gutter	LF	163	\$50	\$8,150
4	Install Concrete - Textured Paving	SF	6740	\$25	\$168,500
5	Install Concrete - Sidewalk/Driveway	SF	1573	\$12	\$18,876
6	Roadway Excavation	CY	3475	\$80	\$278,000
7	Roadway Widening****	LS	1	\$20,712	\$20,712
8	Remove Tree	EA	6	\$1,000	\$6,000
9	Remove Gate	EA	2	\$5,000	\$10,000
10	New Gates	EA	2	\$15,000	\$30,000
11	Pavement Maintenance (includes overlay cost and base repair)	SY	38580	\$19	\$733,020
12	Signing and Striping	LS	1	\$38,330	\$38,330
13	Green MMA (Methyl Methacrylate)	SF	7634	\$10	\$76,340
14	Vertical Delineator (Type K-71)	EA	179	\$200	\$35,800
ELECTRICAL					
15	New Traffic Signal (electrical cost only, civil and signal interconnect costs are accounted for seperatly)	EA	2	\$450,000	\$900,000
16	New Pedestrian Signal	EA	1	\$300,000	\$300,000
17	Signal Modification	EA	4	\$250,000	\$1,000,000
18	Traffic Signal Interconnect and ITS elements	LF	5630	\$41	\$230,830
19	Pedestrian Scale Lighting	EA	140	\$1,500	\$210,000
SUBTOTAL					\$4,409,574
20	Minor Items (10% of Items 1-18) **	LS	1	\$441,000	\$441,000
SUBTOTAL					\$4,850,574
21	Mobilization (10% of Items 1-19)	LS	1	\$486,000	\$486,000
SUBTOTAL					\$5,336,574
CONTINGENCY (30%) ***					\$1,601,000
CONSTRUCTION SUBTOTAL					\$6,937,574
GRAND TOTAL					
CONSTRUCTION SUBTOTAL =					\$6,937,574
Right of Way/Temporary Construction Easement* =					\$370,000
GRAND TOTAL =					\$7,307,574

* Right of way/TCE's for driveway closures, curb ramps, new signal equipment, conforms, etc. have been estimated at \$10K/Location.

** Minor items (for example, fencing, signage, sidewalk repair, utility adjustments, etc.) have been estimated by using a percentage.



*** This feasibility level estimate includes a 30% contingency intended to compensate for the use of limited information.

**** Areas of widening include new pavement structural section (0.50' HMA/1.50' CL2AB)

General Note Where applicable, only minor drainage improvements for transportation projects to address safety are included. Utility improvements such as water, communication, gas, etc. are not included in these estimates.

Broadway/Stockton Boulevard

LEGEND:

-  NEW SIGNAL
-  EXISTING SIGNAL
-  BUS STOP LOCATION

FUTURE ENVISION
BROADWAY
IMPROVEMENTS

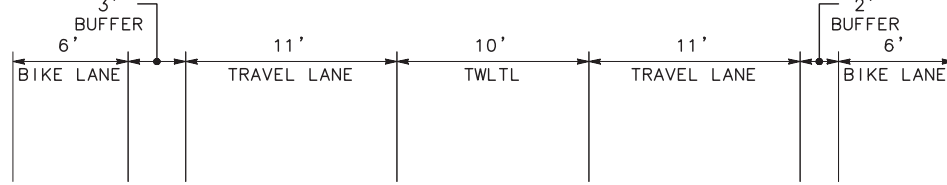
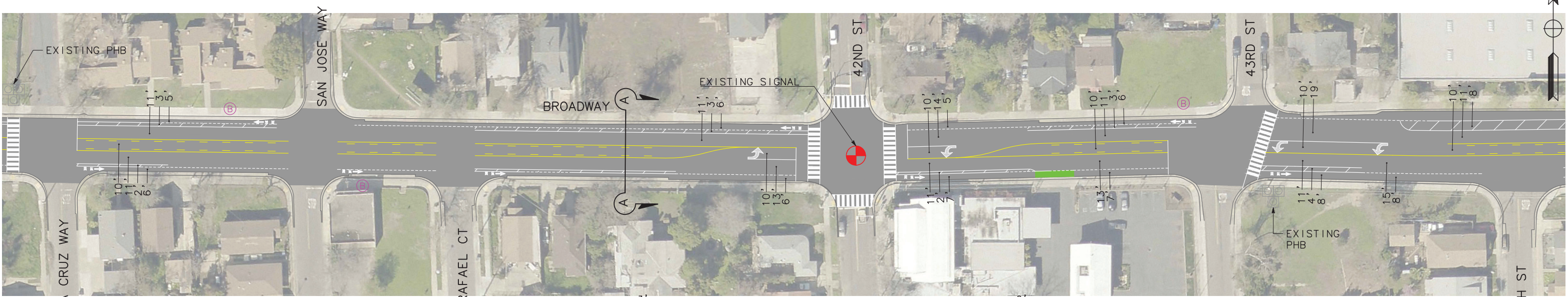
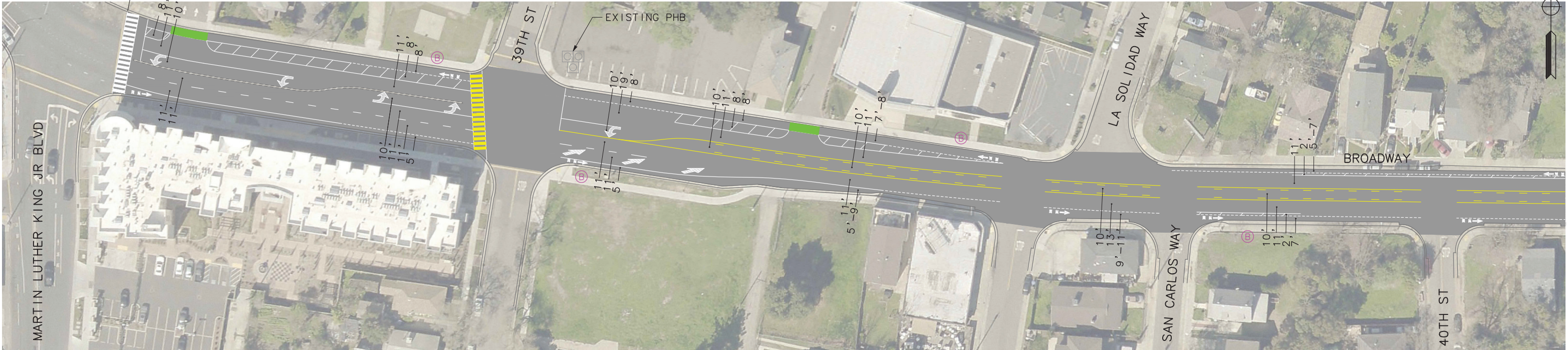

SECTION A-A

VISION ZERO - TOP 5 BROADWAY	
CITY OF SACRAMENTO	 MARK THOMAS

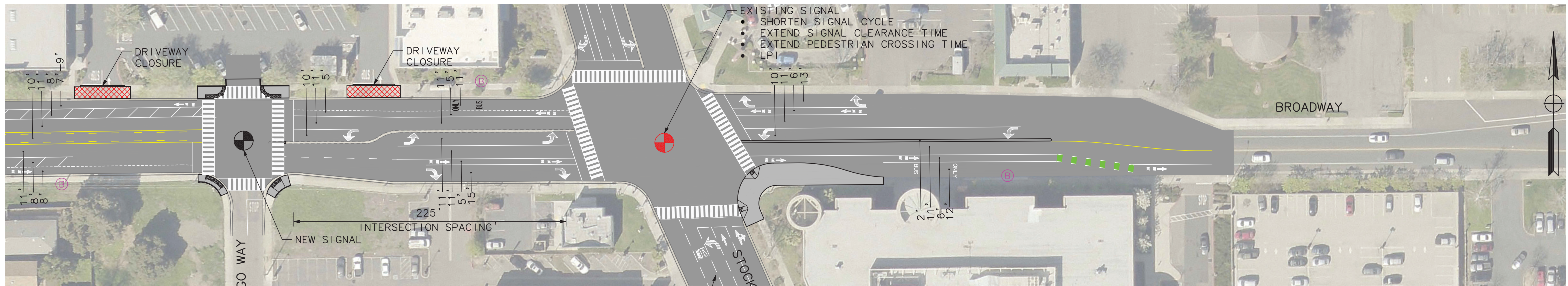

- EXISTING SIGNAL
- SHORTEN SIGNAL CYCLE
- EXTEND SIGNAL CLEARANCE TIME
- EXTEND PEDESTRIAN CROSSING TIME
- LPI

SAN DIEGO WAY

STOCKTON BLVD

BROADWAY

STOCKTON IMPROVEMENTS





NEW SIGNAL

INTERSECTION SPACING

225'

VISION ZERO - TOP 5	
BROADWAY	
CITY OF SACRAMENTO	 MARK THOMAS

LEGEND:

-  TBD WITH STOCKTON BOULEVARD MASTER PLAN
-  EXISTING BUS STOP LOCATION
-  NEW SIGNAL
-  EXISTING SIGNAL
-  DELINEATOR (TYPE K-71)

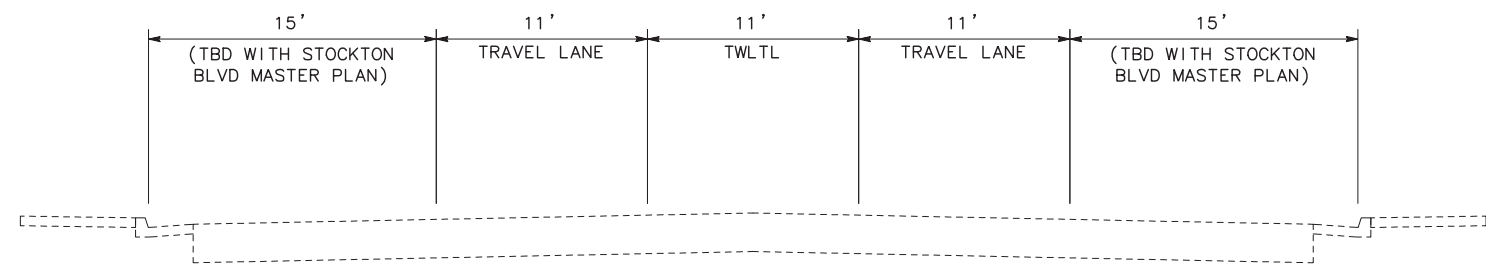
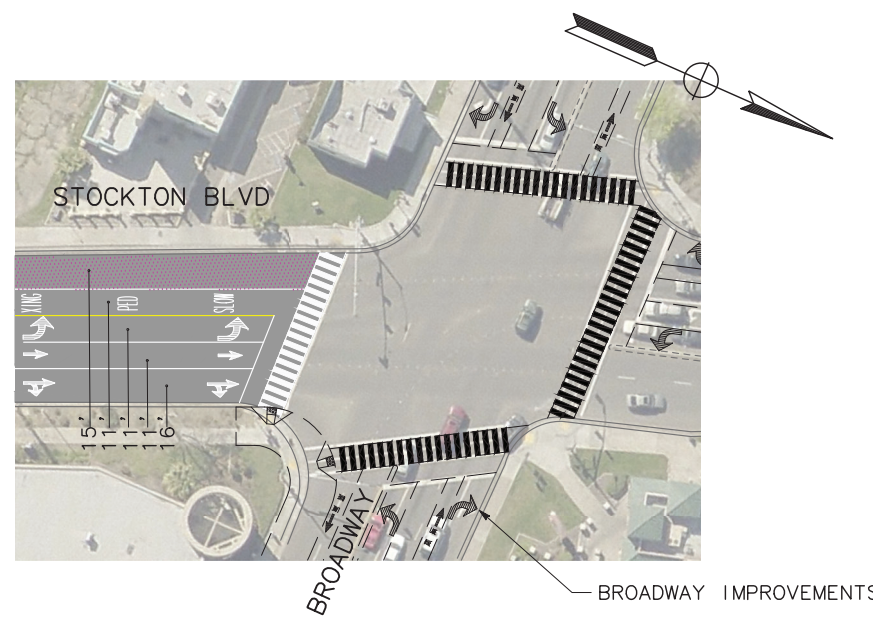
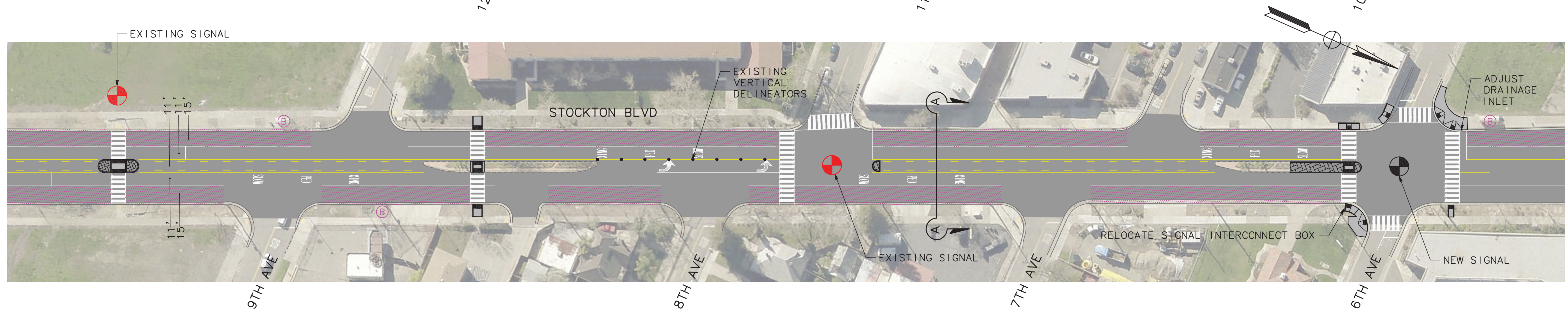
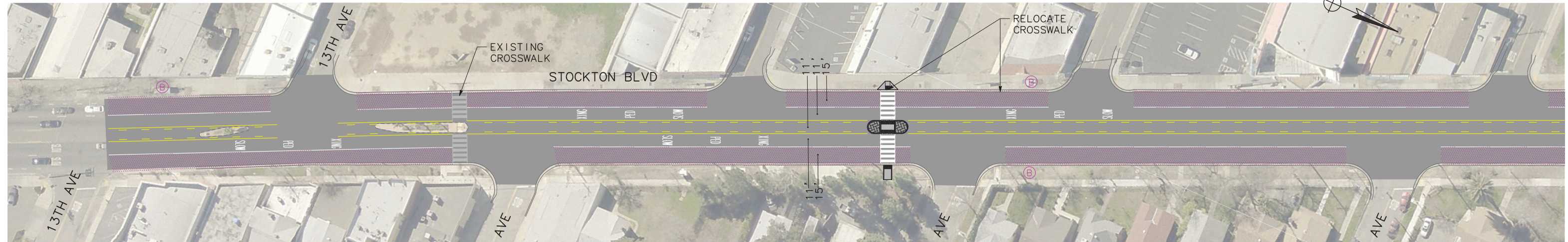

SCALE: 1" = 40'

**VISION ZERO - TOP 5
NORTH STOCKTON BLVD**

CITY OF SACRAMENTO	 MARK THOMAS
-------------------------------	--

Broadway

(Feasibility Opinion of Probable Cost)



MARK THOMAS

SUMMARY OF PROJECT COST ESTIMATE

		Current Year Cost	Escalated Cost (2025)**
TOTAL CONSTRUCTION COST		\$ 2,380,905	\$ 2,760,121
TOTAL RIGHT OF WAY COST		\$ 110,000	\$ 127,520
TOTAL CAPITAL OUTLAY COSTS		\$ 2,491,000	\$ 2,888,000
DESIGN	PA/ED (12.5%)*	\$ 320,000	\$ 380,000
	PS&E (17.5%)	\$ 440,000	\$ 520,000
	RIGHT OF WAY (2%)	\$ 50,000	\$ 60,000
CM	CONSTRUCTION (19%)	\$ 480,000	\$ 560,000
TOTAL DELIVERY COST		\$ 1,290,000	\$ 1,520,000
TOTAL PROJECT COST		\$ 3,790,000	\$ 4,410,000

* Support cost percentages reference the Multi-Agency CIP Benchmarking Study (2019) for streets projects

** Assumes escalation of 3% per year. No Adjustments in escalation for time between design and construction were made.

Broadway
(Feasibility Opinion of Probable Cost)



ITEM No.	ITEM DESCRIPTION	UNIT	QUANTITY	UNIT PRICE	TOTAL
ROADWAY					
1	Install Concrete - Curb Ramp	EA	6	\$8,000	\$48,000
2	Install Concrete - Curb	LF	520	\$30	\$15,600
3	Install Concrete - Curb and Gutter	LF	130	\$50	\$6,500
4	Install Concrete - Sidewalk/Driveway	SF	4070	\$12	\$48,840
5	Roadway Excavation	CY	1752	\$80	\$140,160
6	Pavement Maintenance (includes overlay cost and base repair)	SY	21211	\$19	\$403,009
7	Signing and Striping	LS	1	\$20,716	\$20,716
8	Green MMA (Methyl Methacrylate)	SF	658	\$10	\$6,580
ELECTRICAL					
9	New Traffic Signal (electrical cost only, civil and signal interconnect costs are accounted for seperatly)	EA	1	\$450,000	\$450,000
10	Signal Modification	EA	1	\$250,000	\$250,000
11	Traffic Signal Interconnect and ITS elements	LF	3000	\$41	\$123,000
SUBTOTAL					\$1,512,405
12	Minor Items (10% of Items 1-11) **	LS	1	\$152,000	\$152,000
SUBTOTAL					\$1,664,405
13	Mobilization (10% of Items 1-12)	LS	1	\$167,000	\$167,000
SUBTOTAL					\$1,831,405
CONTINGENCY (30%) ***					\$549,500
CONSTRUCTION SUBTOTAL					\$2,380,905
GRAND TOTAL					
CONSTRUCTION SUBTOTAL=					\$2,380,905
Right of Way/Temporary Construction Easement*=					\$110,000
GRAND TOTAL=					\$2,490,905

* Right of way/TCE's for driveway closures, curb ramps, new signal equipment, conforms, etc. have been estimated at \$10K/Location.
 ** Minor items (for example, fencing, signage, sidewalk repair, utility adjustments, etc.) have been estimated by using a percentage.
 *** This feasibility level estimate includes a 30% contingency intended to compensate for the use of preliminary and limited information.
 General Where applicable, only minor drainage improvements for transportation projects to address safety are included. Utility improvements such as water,
 Note communication, gas, etc. are not included in these estimates.

North Stockton Boulevard

(Feasibility Opinion of Probable Cost)



MARK THOMAS

SUMMARY OF PROJECT COST ESTIMATE

		Current Year Cost	Escalated Cost (2025)**
TOTAL CONSTRUCTION COST		\$ 2,339,705	\$ 2,712,359
TOTAL RIGHT OF WAY COST		\$ 120,000	\$ 139,113
TOTAL CAPITAL OUTLAY COSTS		\$ 2,460,000	\$ 2,852,000
DESIGN	PA/ED (12.5%)*	\$ 310,000	\$ 360,000
	PS&E (17.5%)	\$ 440,000	\$ 520,000
	RIGHT OF WAY (2%)	\$ 50,000	\$ 60,000
CM	CONSTRUCTION (19%)	\$ 470,000	\$ 550,000
TOTAL DELIVERY COST		\$ 1,270,000	\$ 1,490,000
TOTAL PROJECT COST		\$ 3,730,000	\$ 4,350,000

* Support cost percentages reference the Multi-Agency CIP Benchmarking Study (2019) for streets projects

** Assumes escalation of 3% per year. No Adjustments in escalation for time between design and construction were made.

North Stockton Boulevard

(Feasibility Opinion of Probable Cost)

(Estimate does not include improvements from the Stockton Blvd Master Plan)



MARK THOMAS

ITEM No.	ITEM DESCRIPTION	UNIT	QUANTITY	UNIT PRICE	TOTAL
ROADWAY					
1	Install Concrete - Curb Ramp	EA	19	\$8,000	\$152,000
2	Install Concrete - Curb	LF	320	\$30	\$9,600
3	Install Concrete - Curb & Gutter	LF	31	\$50	\$1,550
4	Install Concrete - Textured Paving	SF	764	\$25	\$19,100
5	Install Concrete - Sidewalk	SF	777	\$12	\$9,324
6	Roadway Excavation	CY	1453	\$80	\$116,240
7	Pavement Maintenance (includes overlay cost and base repair)	SY	18167	\$19	\$345,173
8	Signing and Striping	LS	1	\$12,818	\$12,818
9	Relocate Drainage Inlet	EA	1	\$2,000	\$2,000
ELECTRICAL					
10	New Traffic Signal (electrical cost only, civil and signal interconnect costs are accounted for separately)	EA	1	\$450,000	\$450,000
11	Signal Modification	EA	1	\$250,000	\$250,000
12	Traffic Signal Interconnect and ITS elements	LF	2900	\$41	\$118,900
SUBTOTAL					\$1,486,705
13	Minor Items (10% of Items 1-12) **	LS	1	\$149,000	\$149,000
SUBTOTAL					\$1,635,705
14	Mobilization (10% of Items 1-13)	LS	1	\$164,000	\$164,000
SUBTOTAL					\$1,799,705
CONTINGENCY (30%***)					\$540,000
CONSTRUCTION SUBTOTAL					\$2,339,705
GRAND TOTAL					
CONSTRUCTION SUBTOTAL =					\$2,339,705
Right of Way/Temporary Construction Easement* =					\$120,000
GRAND TOTAL =					\$2,459,705

* Right of way/TCE's for driveway closures, curb ramps, new signal equipment, conforms, etc. have been estimated at \$10K/Location.

** Minor items (for example, fencing, signage, sidewalk repair, utility adjustments, etc.) have been estimated by using a percentage.

*** This feasibility level estimate includes a 30% contingency intended to compensate for the use of preliminary and limited information.

General Where applicable, only minor drainage improvements for transportation projects to address safety are included. Utility improvements such as water,

Note communication, gas, etc. are not included in these estimates.

S Stockton Boulevard

LEGEND:

-  EXISTING SIGNAL
-  BUS STOP LOCATION
-  ROADWAY WIDENING AREA

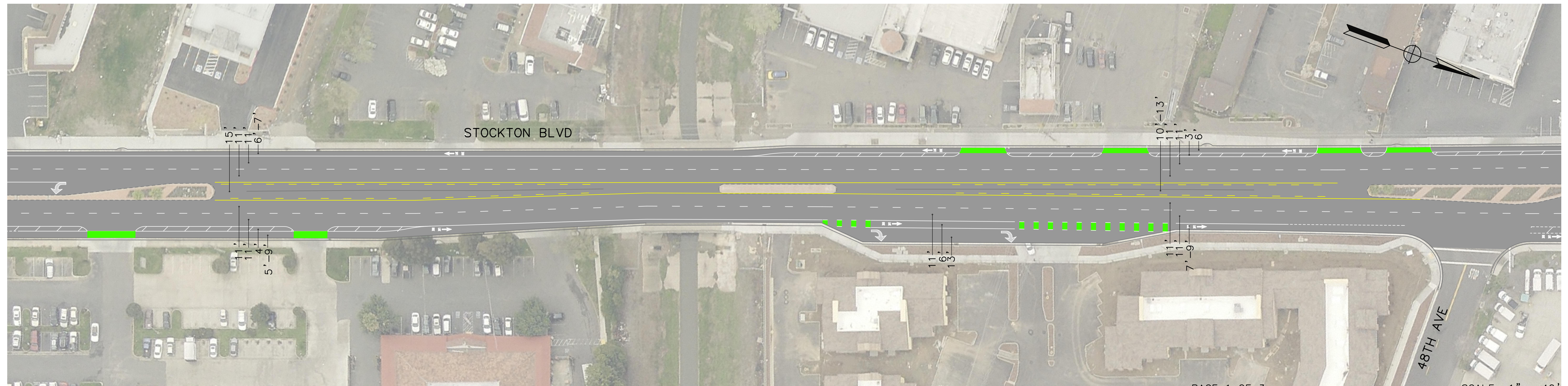
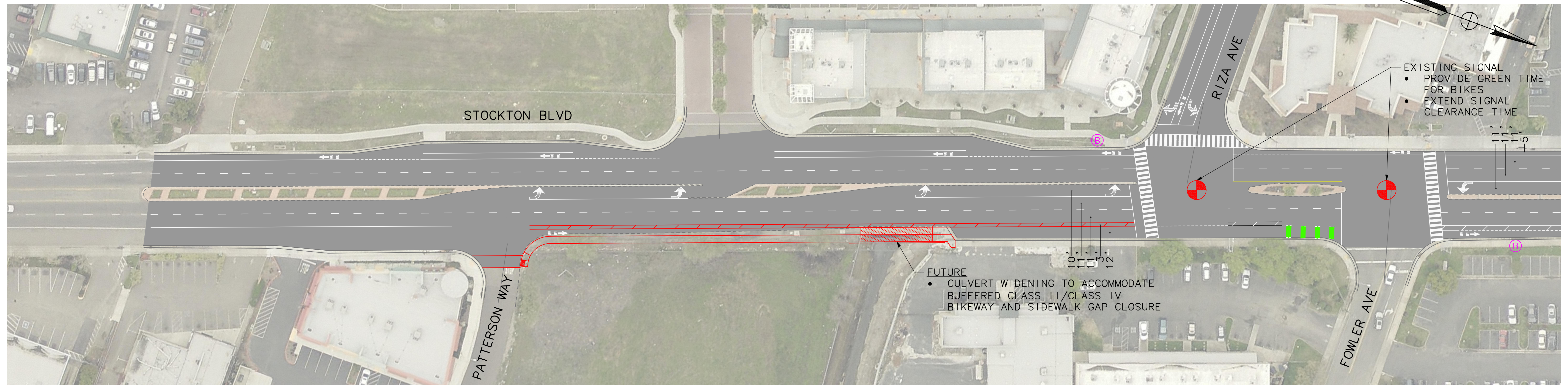

**VISION ZERO - TOP 5
SOUTH STOCKTON BLVD**

**CITY OF
SACRAMENTO**

**MARK
THOMAS**

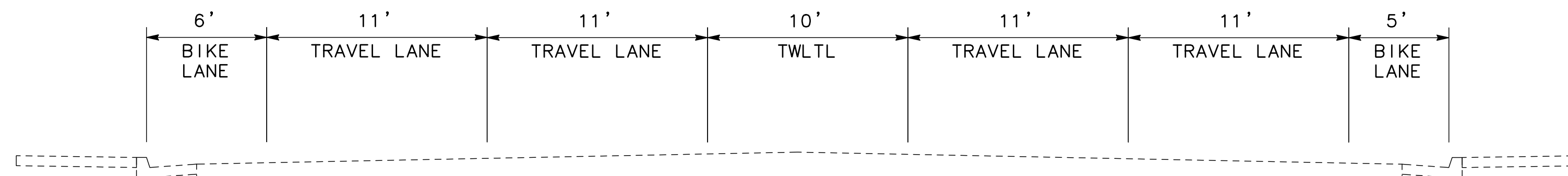
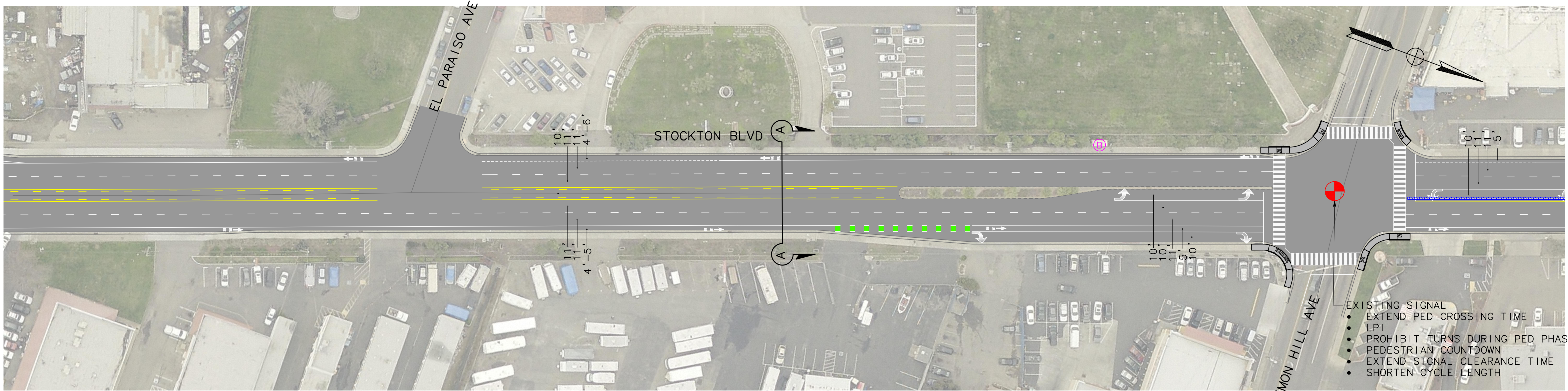
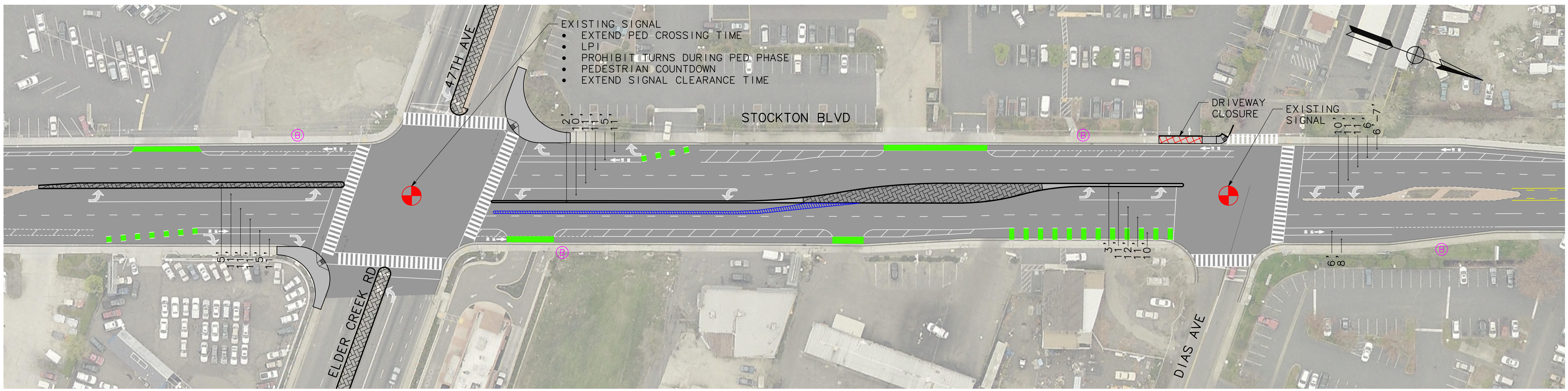

VISION ZERO - TOP 5
SOUTH STOCKTON BLVD

CITY OF SACRAMENTO

MARK THOMAS



VISION ZERO - TOP 5
SOUTH STOCKTON BLVD

CITY OF
SACRAMENTO

MARK
THOMAS

South Stockton Boulevard

(Feasibility Opinion of Probable Cost)



SUMMARY OF PROJECT COST ESTIMATE

		Current Year Cost	Escalated Cost (2025)**
TOTAL CONSTRUCTION COST		\$ 5,254,391	\$ 6,091,279
TOTAL RIGHT OF WAY COST		\$ 130,000	\$ 150,706
TOTAL CAPITAL OUTLAY COSTS		\$ 5,385,000	\$ 6,242,000
DESIGN	PA/ED (12.5%)*	\$ 680,000	\$ 790,000
	PS&E (17.5%)	\$ 950,000	\$ 1,110,000
	RIGHT OF WAY (2%)	\$ 110,000	\$ 130,000
CM	CONSTRUCTION (19%)	\$ 1,030,000	\$ 1,200,000
TOTAL DELIVERY COST		\$ 2,770,000	\$ 3,230,000
TOTAL PROJECT COST		\$ 8,200,000	\$ 9,500,000

* Support cost percentages reference the Multi-Agency CIP Benchmarking Study (2019) for streets projects

** Assumes escalation of 3% per year. No Adjustments in escalation for time between design and construction were made.

South Stockton Boulevard

(Feasibility Opinion of Probable Cost)



MARK THOMAS

ITEM No.	ITEM DESCRIPTION	UNIT	QUANTITY	UNIT PRICE	TOTAL
ROADWAY					
1	Install Concrete - Curb Ramp	EA	14	\$8,000	\$112,000
2	Install Concrete - Curb	LF	3215	\$30	\$96,450
3	Install Concrete - Curb & Gutter	LF	261	\$50	\$13,050
4	Install Concrete - Sidewalk/Driveway	LF	4988	\$12	\$59,856
5	Install Concrete - Textured Paving	LF	9809	\$25	\$245,226
6	Roadway Excavation	CY	4474	\$80	\$357,920
7	Roadway Widening****	LF	1	\$8,159	\$8,159
8	Pavement Maintenance (includes overlay cost and base repair)	SY	49980	\$19	\$949,620
9	Signing and Striping	LS	1	\$41,984	\$41,984
10	Green MMA (Methyl Methacrylate)	SF	3290	\$10	\$32,900
ELECTRICAL					
11	Signal Modification	EA	4	\$250,000	\$1,000,000
12	Traffic Signal Interconnect and ITS elements	LF	5186	\$41	\$212,626
13	Pedestrian Scale Lighting	EA	140	\$1,500	\$210,000
SUBTOTAL					\$3,339,791
14	Minor Items (10% of Items 1-12)**	LS	1	\$334,000	\$334,000
SUBTOTAL					\$3,673,791
15	Mobilization (10% of Items 1-13)	LS	1	\$368,000	\$368,000
SUBTOTAL					\$4,041,791
CONTINGENCY (30%***)					\$1,212,600
CONSTRUCTION SUBTOTAL					\$5,254,391
GRAND TOTAL					
CONSTRUCTION SUBTOTAL =					\$5,254,391
Right of Way/Temporary Construction Easement * =					\$130,000
GRAND TOTAL =					\$5,384,391

* Right of way/TCE's for driveway closures, curb ramps, new signal equipment, conforms, etc. have been estimated at \$10K/Location.

** Minor items (for example, fencing, signage, sidewalk repair, utility adjustments, etc.) have been estimated by using a percentage.





*** This feasibility level estimate includes a 30% contingency intended to compensate for the use of preliminary and limited information.

**** Areas of widening include new pavement structural section (0.50' HMA/1.50' CL2AB)

General Note Where applicable, only minor drainage improvements for transportation projects to address safety are included. Utility improvements such as water, communication, gas, etc. are not included in these estimates.

Florin Road

LEGEND:

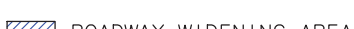
-  BUS STOP LOCATION
-  NEW SIGNAL
-  EXISTING SIGNAL
-  DELINEATOR (TYPE K-71)
-  LANDSCAPE AREA
-  ROADWAY WIDENING AREA

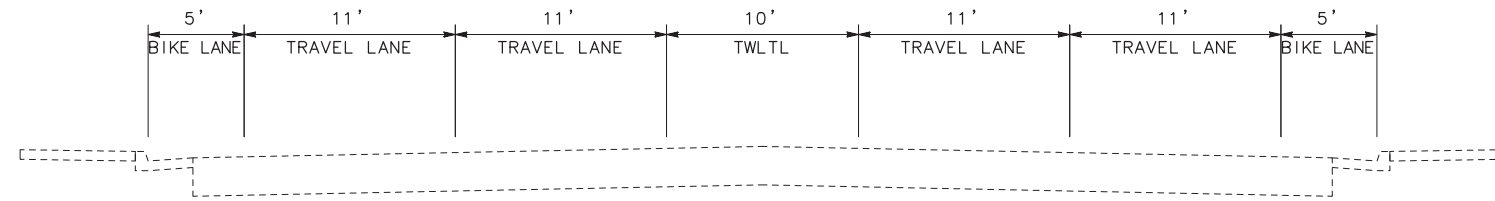

SECTION A-A

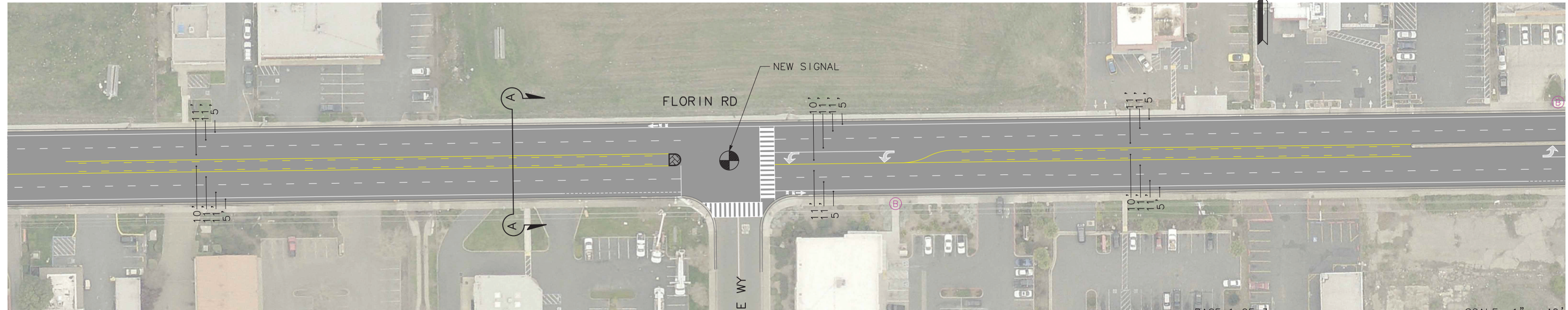

VISION ZERO - TOP 5 FLORIN RD	
CITY OF SACRAMENTO	 MARK THOMAS

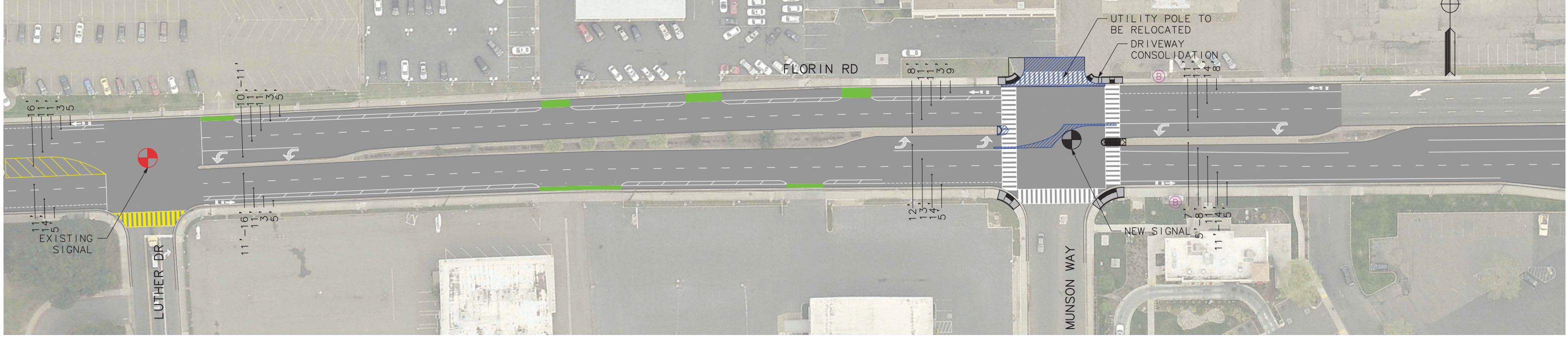

VISION ZERO - TOP 5	
FLORIN RD	
CITY OF SACRAMENTO	MARK THOMAS

Florin Road

(Feasibility Opinion of Probable Cost)



MARK THOMAS

SUMMARY OF PROJECT COST ESTIMATE

		Current Year Cost	Escalated Cost (2025)**
TOTAL CONSTRUCTION COST		\$ 6,489,586	\$ 7,523,209
TOTAL RIGHT OF WAY COST		\$ 265,000	\$ 307,208
TOTAL CAPITAL OUTLAY COSTS		\$ 6,755,000	\$ 7,831,000
DESIGN	PA/ED (12.5%)*	\$ 850,000	\$ 990,000
	PS&E (17.5%)	\$ 1,190,000	\$ 1,380,000
	RIGHT OF WAY (2%)	\$ 140,000	\$ 170,000
CM	CONSTRUCTION (19%)	\$ 1,290,000	\$ 1,500,000
TOTAL DELIVERY COST		\$ 3,470,000	\$ 4,040,000
TOTAL PROJECT COST		\$ 10,250,000	\$ 11,900,000

* Support cost percentages reference the Multi-Agency CIP Benchmarking Study (2019) for streets projects

** Assumes escalation of 3% per year. No Adjustments in escalation for time between design and construction were made.

Florin Road
(Feasibility Opinion of Probable Cost)



ITEM No.	ITEM DESCRIPTION	UNIT	QUANTITY	UNIT PRICE	TOTAL
ROADWAY					
1	Install Concrete - Curb Ramp	EA	17	\$8,000	\$136,000
2	Install Concrete - Curb	LF	3716	\$30	\$111,480
3	Install Concrete - Curb & Gutter	LF	119	\$50	\$5,950
4	Install Concrete - Sidewalk/Driveway	SF	10145	\$12	\$121,740
5	Install Concrete - Textured Paving	SF	431	\$25	\$10,775
6	Roadway Excavation	CY	4375	\$80	\$350,000
7	Road Widening****	LS	1	\$43,647	\$43,647
8	Pavement Maintenance (includes overlay cost and base repair)	SY	47726	\$19	\$906,794
9	Signing and Striping	LS	1	\$46,471	\$46,471
10	Green MMA (Methyl Methacrylate)	SF	2334	\$10	\$23,340
11	Vertical Delineator (Type K-71)	EA	28	\$200	\$5,600
12	Landscape/Irrigation	SF	3619	\$8	\$28,952
13	Relocate Utility Pole	EA	1	\$30,000	\$30,000
ELECTRICAL					
14	New Traffic Signal (electrical cost only, civil and signal interconnect costs are accounted for seperatly)	EA	3	\$450,000	\$1,350,000
15	Signal Modification	EA	2	\$250,000	\$500,000
16	Traffic Signal Interconnect and ITS elements	LF	5957	\$41	\$244,237
17	Pedestrian Scale Lighting	EA	140	\$1,500	\$210,000
SUBTOTAL					\$4,124,986
17	Minor Items (10% of Items 1-16) **	LS	1	\$413,000	\$413,000
SUBTOTAL					\$4,537,986
18	Mobilization (10% of Items 1-17)	LS	1	\$454,000	\$454,000
SUBTOTAL					\$4,991,986
CONTINGENCY (30%***)					\$1,497,600
CONSTRUCTION SUBTOTAL					\$6,489,586
GRAND TOTAL					
CONSTRUCTION SUBTOTAL =					\$6,489,586
Right of Way/Temporary Construction Easement* =					\$240,000
Permanent Right of Way Acquisition =					\$25,000
GRAND TOTAL =					\$6,754,586

* Right of way/TCE's for driveway closures, curb ramps, new signal equipment, conforms, etc. have been estimated at \$10K/Location.
 ** Minor items (for example, fencing, signage, sidewalk repair, utility adjustments, etc.) have been estimated by using a percentage.
 *** This feasibility level estimate includes a 30% contingency intended to compensate for the use of preliminary and limited information.
 **** Areas of widening include new pavement structural section (0.50' HMA/1.50' CL2AB)
 General Where applicable, only minor drainage improvements for transportation projects to address safety are included. Utility improvements such as water,
 Note communication, gas, etc. are not included in these estimates.

Vision Zero Top 5 Corridors

FAQs



The Vision Zero Top 5 Corridors study represents a next step of the Sacramento Vision Zero Action Plan, focusing efforts on implementing near-term roadway improvements on the five corridors in the city that have the highest rate of crashes that result in fatalities and severe injuries. During public outreach and public comment of this study, a few common questions were posed that were not covered in the Vision Zero Top 5 Corridors report. Responses to those questions are provided below.

1. Why aren't new trees and landscaping included in the Plan?

The recommendations in the Vision Zero Top 5 Corridors Plan are focused on roadway design features that will improve safety based on the collision data that was analyzed. The project team did not identify locations in which a landscape buffer addressed collisions and was a feasible option. There are some recommendations that will require changes to the existing landscaping, such as the modified sidewalk on Florin Rd. and the realignment of the intersection of El Camino Rd. and the Sacramento Northern Bike Trail. This plan does not preclude new trees, landscaping, and other placemaking elements from being considered in the future where there is available space and financial resources to maintain.

2. Why does the plan propose so many new traffic signals?

New traffic signals organize interactions between vehicles, pedestrians, and bicyclists with conflicting movements, and provide an improved crossing for pedestrians. New traffic signals can also slow traffic on long, high-speed straightaways when timed properly. Consistently spaced traffic signals facilitate the “slow green wave” in which signals are coordinated for slower travel speeds.

3. Can you set lower speed limits to reduce speed?

Cities in the State of California must adhere to the California Vehicle Code for setting speed limits. The process for setting speed limits on non-residential streets includes conducting a specific speed survey to determine the, “prevailing speed.” The prevailing speed is the speed which 85 percent of the motorists are traveling at or below. The speed limit is set using the prevailing speed, with considerations for other factors such as the type of adjacent development, bicycle and pedestrian activity, and reported collision history. This process prohibits cities from arbitrarily setting speed limits. Roadway design can help to influence prevailing speeds, meaning that in the future a lower speed limit may be warranted along corridors where roadway safety improvements have been made.

4. Will my street be considered for safety improvements?

Per the City of Sacramento's Vision Zero Action Plan, safety improvements are prioritized where historic collision data points to the most need. These locations together are called the High Injury Network. The City's transportation funding priorities include an emphasis on funding future safety projects on the High Injury Network.